



ALLIED MACHINE & ENGINEERING

Holemaking Solutions for Today's Manufacturing



Boring



Reaming



Burnishing



Threading

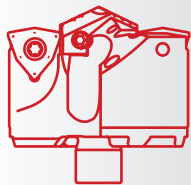

Specials



APX™ Drill

▶ **DRILLING**

Deep Hole / Large Diameter Drilling System

SECTION

A50

APX™ Drill

APX™ Drill

Deep Hole / Large Diameter Drilling System

► Diameter Range: 1.299" - 4.000" (33.00 mm - 101.60 mm)



Don't Let Your Machine Slow You Down

The APX deep hole/large diameter drilling system delivers the strength and versatility needed for any deep hole drilling application. The breakthrough geometry is designed to increase penetration rates and tool life. By allowing for higher spindle speeds, the APX lets you take advantage of the power curve on modern CNC machines.

Excellent chip control	Improves hole quality and surface finish	Provides maximum durability and stability
------------------------	------------------------------------------	-------------------------------------------

Applicable Industries

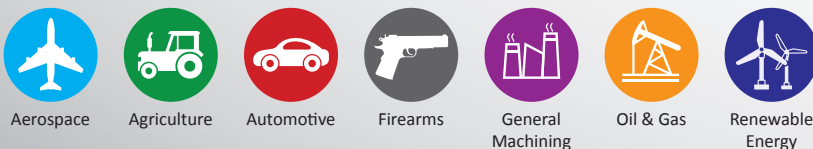

Your safety and the safety of others is very important. This catalog contains important safety messages. Always read and follow all safety precautions.



This triangle is a safety hazard symbol. It alerts you to potential safety hazards that can cause tool failure and serious injury.

When you see this symbol in the catalog, look for a related safety message that may be near this triangle or referred to in the nearby text.

There are safety signal words also used in the catalog. Safety messages follow these words.

WARNING

WARNING (shown above) means that failure to follow the precautions in this message could result in tool failure and serious injury.

NOTICE means that failure to follow the precautions in this message could result in damage to the tool or machine but not result in personal injury.

NOTE and **IMPORTANT** are also used. These are important that you read and follow but are not safety-related.

Visit www.alliedmachine.com for the most up-to-date information and procedures.

Reference Icons

The following icons will appear throughout the catalog to help you navigate between products.



Setup / Assembly Information

Detailed instructions and information regarding the corresponding part(s)

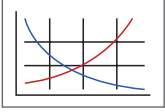

Recommended Cutting Data

Speed and feed recommendations for optimum and safe drilling

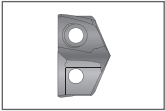

GEN3SYS® Pilot Inserts

Lists the GEN3SYS XT Pro pilot ISO insert options for each APX drill series

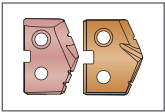

T-A® Pilot Inserts

Lists the T-A® and GEN2 T-A® pilot insert options for each APX Drill series



Coolant-Through Option

Indicates that the product is coolant through

Series	Diameter Range	
	Imperial (inch)	Metric (mm)
33	1.299 - 1.496	33.00 - 37.99
38	1.496 - 1.732	38.00 - 43.99
44	1.732 - 2.008	44.00 - 50.99
51	2.008 - 2.244	51.00 - 56.99
57	2.244 - 2.480	57.00 - 62.99
63	2.480 - 2.756	63.00 - 69.99
70	2.756 - 2.992	70.00 - 75.99
76	2.992 - 3.268	76.00 - 82.99
83	3.268 - 3.504	83.00 - 88.99
89	3.504 - 3.740	89.00 - 94.99
95	3.740 - 4.000	95.00 - 101.60

Introduction Information

Drill Selection Guide / Assembly Details 2 - 3
 Pilot Insert Options / Details 4
 Product Nomenclature 5















Drill Series

33 Series 6 - 7
 38 Series 8 - 9
 44 Series 10 - 11
 51 Series 12 - 13
 57 Series 14 - 15
 63 Series 16 - 17
 70 Series 18 - 19
 76 Series 20 - 21
 83 Series 22 - 23
 89 Series 24 - 25
 95 Series 26 - 27

Recommended Cutting Data

Imperial (inch) 28
 Metric (mm) 29
 Deep Hole Drilling Guidelines 30

Drill Selection Guide

Series	33	38	44	51	57
					
Page	6 - 7	8 - 9	10 - 11	12 - 13	14 - 15
D ₅ inch	1.299 - 1.496	1.496 - 1.732	1.732 - 2.008	2.008 - 2.244	2.244 - 2.480
D ₅ mm	33.00 - 37.99	38.00 - 43.99	44.00 - 50.99	51.00 - 56.99	57.00 - 62.99
ISO Material					
IC Insert Shape					
IC Insert Size (inch)	5/16"	3/8"	3/8", 1/2"	1/2", 9/16"	9/16"
IC Insert Size (mm)	7.94	9.53	9.53, 12.70	12.70, 14.29	14.29
Wear Pads	NO	NO	NO	NO	NO
Holders					
Drill Depth (inch)	4-7/16 - 14-29/32	5-1/8 - 17-1/4	6 - 20-1/8	6-3/8 - 22-3/8	7-1/8 - 24-3/4
Drill Depth (mm)	112.6 - 378.6	130.5 - 439.9	151.5 - 510.0	161.8 - 570.0	179.9 - 626.9
Pilot Insert					
T-A Series	0, 1	0, 1	1	1	1, 2
GEN3SYS XT Pro Series	-	15, 17, 18, 20	17, 18, 22	18, 20, 22	22, 24, 26



T-A® Style Pilot Insert Head

- Utilizes both T-A Pro and T-A inserts (0 - 2 series)
- Multiple geometry options are available to achieve optimal results in different types of applications



GEN3SYS® XT Style Pilot Insert Head

- Utilizes GEN3SYS XT Pro inserts (15 - 32 series)
- ISO geometry options are available to achieve optimal results in different types of applications



IC Insert AM300®

- The design allows for excellent chip control and aggressive penetration rates
- The proprietary AM300 coatings increase tool life above competitors' premium coatings

Insert Application Recommendations

Carbide Grade Options

C5 (P35)	General purpose carbide grade suitable for most applications. ▶ Common application in steels and stainless steels.
C1 (K35)	Toughest carbide grade. Provides the best combination of edge strength and tool life. ▶ Recommended for less rigid applications.
C2 (K25)	Higher wear-resistant carbide suitable for abrasive material applications. ▶ Recommended for grey, ductile, and nodular irons.

Additional Geometry Option

High Rake (HR)	Provides superior chip control and tool life in long-chipping carbon and alloy steels below 200 Bhn.
----------------	------------------------------------------------------------------------------------------------------



Flanged Straight Shank



CAT40 / CAT50 Integral Shank

63	70	76	83	89	95
					
16 - 17	18 - 19	20 - 21	22 - 23	24 - 25	26 - 27
2.480 - 2.756	2.756 - 2.992	2.992 - 3.268	3.268 - 3.504	3.504 - 3.740	3.740 - 4.000
63.00 - 69.99	70.00 - 75.99	76.00 - 82.99	83.00 - 88.99	89.00 - 94.99	95.00 - 101.60
					
					
9/16"	3/8"	1/2"	1/2"	9/16"	9/16"
14.29	9.53	12.70	12.70	14.29	14.29
NO	YES	YES	YES	YES	YES
7-7/8 - 27-1/8	8-3/4 - 27-7/8	9-1/2 - 26-1/8	10-1/8 - 27-3/4	10-7/8 - 27-5/8	11-7/8 - 27-1/2
200.8 - 688.3	218.8 - 709.4	239.9 - 664.0	257.8 - 704.9	275.8 - 701.8	302.0 - 698.5
2	2	2	2	2	2
26, 29, 32	29	29	32	29	32



Step 1:

Lower the APX head assembly onto the APX holder.



Step 2:

Insert the head mounting screws into points A and B. Tighten until the head is properly secured to the holder.

Step 3:

Tighten with the head mounting driver using the torque setting chart below.

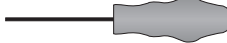
Torque Setting Chart

Series	Screw	Driver	Torque
33 - 63	75020-IP20-1	 8IP-20	60 in-lb (678 N-cm)
70 - 95	78027-IP30-1	 8IP-30B	250 in-lb (2825 N-cm)

Pilot Insert Options

A DRILLING
B BORING
C REAMING
D BURNISHING
E THREADING
X SPECIALS

T-A® Pilot Inserts



T-A Pro P - Steels

- Designed to provide increased penetration rates and tool life in steel applications
- Superior geometry and edge provides excellent chip control
- Allied's multilayer AM300® coating increases heat resistance and improves tool life

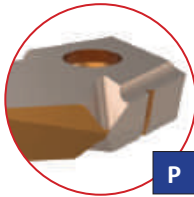

P

T-A Pro K - Cast Irons

- Uniquely designed for cast/ductile iron applications
- Geometry developed for maximum tool life, reduced exit burr, and improved hole finish
- Allied's multilayer TiAlN coating provides increased abrasion resistance and tool life



K

T-A Pro N - Nonferrous Materials

- Designed for applications in aluminum, brass, and copper
- The geometry yields excellent chip control in these softer materials
- TiCN coating gives the versatility to run in a variety of materials while reducing buildup



N

T-A Pro M - Stainless Steel

- Designed for all stainless steels and heat-resistant super alloys
- Geometry optimized for improved chip formation while minimizing exit burr
- Allied's new AM460 coating provides industry leading tool life in stainless and HRSA materials



M

T-A Pro X - High-Speed Steel Materials

- Improved chip geometry for excellent chip control in all materials
- Long tool life and high-process security for the most challenging applications
- Allied's multilayer AM200® coating combines excellent heat resistance and high lubricity for wide application use



X

T-A Standard

- Excellent choice for general purpose use
- Provides fast penetration rates that produce good hole size and finish
- Combines highly efficient, stable cutting action to minimize power consumption

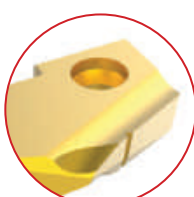

T-A Tiny Chip (-TC)

- Unique lip and point design for excellent chip control
- Improved capabilities in long-chipping materials such as low-carbon steels and soft alloy steels
- Enhanced performance in lower-powered machines for better chip formation at lower feed rates



T-A High Impact (-HI)

- Designed to enhance chip formation in materials with high elasticity/ductility and poor chip forming characteristics
- SK2 corner preparation for increased tool life
- Improves chip formation in structural, cast, and forged steels

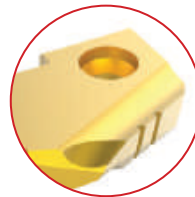

GEN3SYS® XT Pro Pilot Inserts

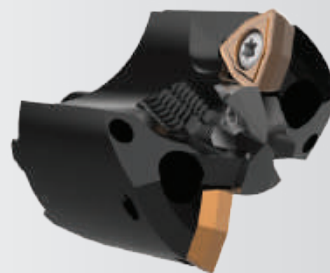

P - Steels

- Designed to provide increased penetration rates and tool life in steel applications
- Superior geometry and edge provides excellent chip control
- Allied's multilayer AM420 coating increases heat resistance and improves tool life

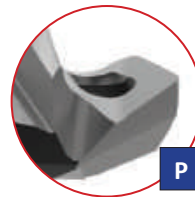

P

K - Cast Irons

- Uniquely designed for cast/nodular iron applications
- Geometry includes a corner radius for improved hole finish and heat dispersion
- Allied's multilayer AM440 coating provides increased abrasion resistance and tool life



K

N - Nonferrous Materials

- Designed for applications in aluminum, brass, and copper
- The geometry yields excellent chip control in these softer materials
- TiN coating gives the versatility to run in a variety of materials while reducing buildup

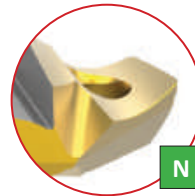

N

NOTE: For a complete offering of pilot inserts, see sections **A20** (GEN3SYS Drilling Systems), **A25** (T-A Pro Drilling Systems) and **A30** (T-A Drilling Systems) of our catalog.

Product Nomenclature

APX Drill Heads

V	38	15	D	-	0116
1	2	3	4		5

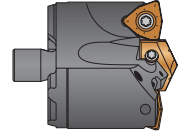

1. APX Head	2. Series	3. Pilot Series																														
V = Head	<table border="0"> <tr> <td>33 = 33 series</td> <td>70 = 70 series</td> </tr> <tr> <td>38 = 38 series</td> <td>76 = 76 series</td> </tr> <tr> <td>44 = 44 series</td> <td>83 = 83 series</td> </tr> <tr> <td>51 = 51 series</td> <td>89 = 89 series</td> </tr> <tr> <td>57 = 57 series</td> <td>95 = 95 series</td> </tr> <tr> <td>63 = 63 series</td> <td></td> </tr> </table>	33 = 33 series	70 = 70 series	38 = 38 series	76 = 76 series	44 = 44 series	83 = 83 series	51 = 51 series	89 = 89 series	57 = 57 series	95 = 95 series	63 = 63 series		<table border="0"> <tr> <th>T-A® Pilot Insert</th> <th colspan="2">GEN3SYS® XT Pro Pilot Insert</th> </tr> <tr> <td>00 = 0 series</td> <td>15 = 15 series</td> <td>24 = 24 series</td> </tr> <tr> <td>01 = 1 series</td> <td>17 = 17 series</td> <td>26 = 26 series</td> </tr> <tr> <td>02 = 2 series</td> <td>18 = 18 series</td> <td>29 = 29 series</td> </tr> <tr> <td></td> <td>20 = 20 series</td> <td>32 = 32 series</td> </tr> <tr> <td></td> <td>22 = 22 series</td> <td></td> </tr> </table>	T-A® Pilot Insert	GEN3SYS® XT Pro Pilot Insert		00 = 0 series	15 = 15 series	24 = 24 series	01 = 1 series	17 = 17 series	26 = 26 series	02 = 2 series	18 = 18 series	29 = 29 series		20 = 20 series	32 = 32 series		22 = 22 series	
33 = 33 series	70 = 70 series																															
38 = 38 series	76 = 76 series																															
44 = 44 series	83 = 83 series																															
51 = 51 series	89 = 89 series																															
57 = 57 series	95 = 95 series																															
63 = 63 series																																
T-A® Pilot Insert	GEN3SYS® XT Pro Pilot Insert																															
00 = 0 series	15 = 15 series	24 = 24 series																														
01 = 1 series	17 = 17 series	26 = 26 series																														
02 = 2 series	18 = 18 series	29 = 29 series																														
	20 = 20 series	32 = 32 series																														
	22 = 22 series																															

4. Effective Cutting	5. Major Diameter
D = Double effective S = Single effective	0116 = Inch 1.5153 = Decimal 68 = Metric

Ordering Nonstocked Diameters:

Non-stocked diameters are also available. Please refer to the price list for applicable process fees. Follow the ordering examples below:

- Inch: 38 series, T-A (1 series), 1.6790" = **V3801D-1.6790**
- Metric: 38 series, T-A (1 series), 42.15 mm = **V3801D-42.15**

APX Drill Holders

W	38	05	H	-	200F
1	2	3	4		5

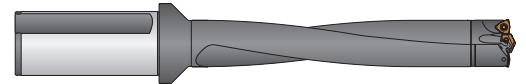

1. APX Holder	2. Series	3. Drill Length	4. Flute Style	5. Shank																						
W = Holder	<table border="0"> <tr> <td>33 = 33 series</td> <td>70 = 70 series</td> </tr> <tr> <td>38 = 38 series</td> <td>76 = 76 series</td> </tr> <tr> <td>44 = 44 series</td> <td>83 = 83 series</td> </tr> <tr> <td>51 = 51 series</td> <td>89 = 89 series</td> </tr> <tr> <td>57 = 57 series</td> <td>95 = 95 series</td> </tr> <tr> <td>63 = 63 series</td> <td></td> </tr> </table>	33 = 33 series	70 = 70 series	38 = 38 series	76 = 76 series	44 = 44 series	83 = 83 series	51 = 51 series	89 = 89 series	57 = 57 series	95 = 95 series	63 = 63 series		<table border="0"> <tr> <td>03 = 3xD</td> </tr> <tr> <td>05 = 5xD</td> </tr> <tr> <td>08 = 8xD</td> </tr> <tr> <td>10 = 10xD</td> </tr> </table>	03 = 3xD	05 = 5xD	08 = 8xD	10 = 10xD	H = Helical	<table border="0"> <tr> <td>150F = 1-1/2" flanged straight shank</td> </tr> <tr> <td>200F = 2" flanged straight shank</td> </tr> <tr> <td>40FM = 40mm flanged straight shank</td> </tr> <tr> <td>50FM = 50mm flanged straight shank</td> </tr> <tr> <td>CV40 = CAT40 integral shank</td> </tr> <tr> <td>CV50 = CAT50 integral shank</td> </tr> </table>	150F = 1-1/2" flanged straight shank	200F = 2" flanged straight shank	40FM = 40mm flanged straight shank	50FM = 50mm flanged straight shank	CV40 = CAT40 integral shank	CV50 = CAT50 integral shank
33 = 33 series	70 = 70 series																									
38 = 38 series	76 = 76 series																									
44 = 44 series	83 = 83 series																									
51 = 51 series	89 = 89 series																									
57 = 57 series	95 = 95 series																									
63 = 63 series																										
03 = 3xD																										
05 = 5xD																										
08 = 8xD																										
10 = 10xD																										
150F = 1-1/2" flanged straight shank																										
200F = 2" flanged straight shank																										
40FM = 40mm flanged straight shank																										
50FM = 50mm flanged straight shank																										
CV40 = CAT40 integral shank																										
CV50 = CAT50 integral shank																										

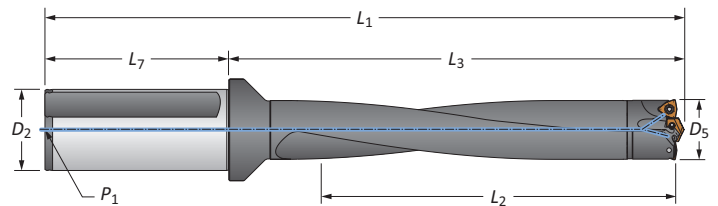
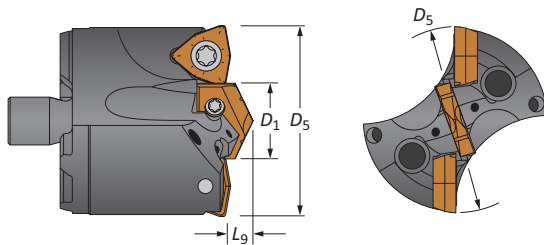

Reference Key

Symbol	Attribute
D ₁	Pilot insert diameter
D ₅	Major cutting diameter
L ₉	Pilot insert length

Reference Key

Symbol	Attribute	Symbol	Attribute
D ₂	Shank diameter	L ₃	Holder reference length
D ₅	Drill diameter range	L ₇	Shank length
L ₁	Overall length	P ₁	Rear pipe tap
L ₂	Drill depth		

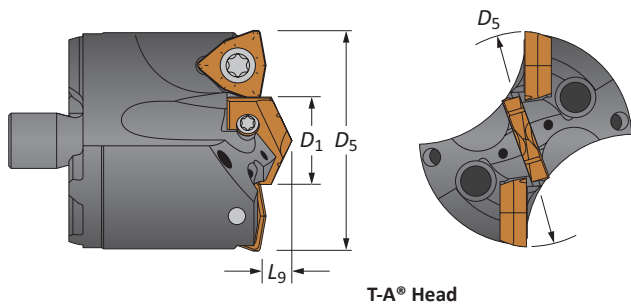

APX Drill Heads

33 Series | Diameter Range: 1.299" - 1.496" (33.00 mm - 37.99 mm)





T-A® Head

Heads

Head					T-A Head				IC Insert Size	
D_5 fractional	D_5 inch	D_5 metric	D_1	L_9	Part No.	Pilot Series			inch	metric
-	1.299	33.00	16	1/4	V3300D-33	0	TA#0-16.00	1C10H-16-TC	5/16	7.94
1-5/16	1.313	33.34	16	1/4	V3300D-0110	0	TA#0-16.00	1C10H-16-TC	5/16	7.94
-	1.339	34.00	18	1/4	V3301D-34	1	TA#1-18.00	1C11H-18-TC	5/16	7.94
1-11/32	1.344	34.13	18	1/4	V3301D-0111	1	TA#1-18.00	1C11H-18-TC	5/16	7.94
1-3/8	1.375	34.93	18	1/4	V3301D-0112	1	TA#1-18.00	1C11H-18-TC	5/16	7.94
-	1.378	35.00	18	1/4	V3301D-35	1	TA#1-18.00	1C11H-18-TC	5/16	7.94
1-13/32	1.406	35.72	18	1/4	V3301D-0113	1	TA#1-18.00	1C11H-18-TC	5/16	7.94
-	1.417	36.00	20	1/4	V3301D-36	1	TA#1-20.00	1C11H-20-TC	5/16	7.94
1-7/16	1.438	36.51	20	1/4	V3301D-0114	1	TA#1-20.00	1C11H-20-TC	5/16	7.94
-	1.457	37.00	20	1/4	V3301D-37	1	TA#1-20.00	1C11H-20-TC	5/16	7.94
1-15/32	1.469	37.31	20	1/4	V3301D-0115	1	TA#1-20.00	1C11H-20-TC	5/16	7.94

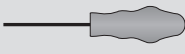

#Denotes ISO material/geometry (P= steel, K= cast iron, N= nonferrous)

IC Inserts

Coating	Size		Grade	Geometry	 Part No.	 Insert Screw	 Insert Driver	Admissible Tightening Torque*
	inch	metric						
AM300®	5/16	7.94	C5 (P35)	Standard	OP-05T308-PW	IS-10-1	8IP-10	27.0 in-lbs (305 N-cm)
AM300®	5/16	7.94	C1 (K35)	Standard	OP-05T308-1PW	IS-10-1	8IP-10	27.0 in-lbs (305 N-cm)
AM300®	5/16	7.94	C2 (K25)	Standard	OP-05T308-2PW	IS-10-1	8IP-10	27.0 in-lbs (305 N-cm)
AM300®	5/16	7.94	C5 (P35)	High Rake	OP-05T308-PWHR	IS-10-1	8IP-10	27.0 in-lbs (305 N-cm)

*Tightening torques are calculated with a friction coefficient of $\mu = 0.14$ and develop 90% of ultimate yield strength

Pilot Accessories

Pilot Style	Series	 Insert Screws	 Insert Driver	Admissible Tightening Torque*
T-A	0	72567-IP8-1	8IP-8	15.5 in-lbs (175 N-cm)
T-A	1	7375-IP9-1	8IP-9	27.0 in-lbs (305 N-cm)

*Tightening torques are calculated with a friction coefficient of $\mu = 0.14$ and develop 90% of ultimate yield strength

A50: 28 - 29

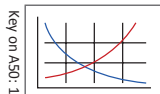

A50: 2 - 5



Section A25 & A30

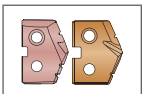

Nonstocked diameters are also available. Follow the examples shown below.

Inch	38 series, T-A (1 series), 1.6790"	Part No. = V3801D-1.6790
Metric	38 series, T-A (1 series), 42.15 mm	Part No. = V3801D-42.15

IC inserts sold in multiples of 2 | Insert screws sold in multiples of 10

APX Drill Holders

33 Series | Diameter Range: 1.299" - 1.496" (33.00 mm - 37.99 mm)

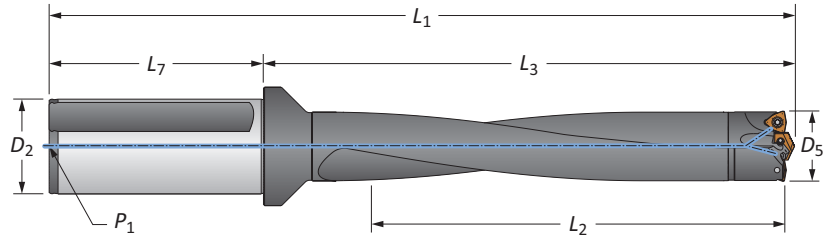

Straight Shank

	Length	D ₅	Body			Shank			Part No.
			L ₂	L ₃	L ₁	L ₇	D ₂	P ₁	
i	3xD	1.299 - 1.496	4-7/16	6-19/32	9-9/32	2-11/16	1-1/2	1/4 NPT	W3303H-150F
	5xD	1.299 - 1.496	7-27/64	9-37/64	12-9/32	2-11/16	1-1/2	1/4 NPT	W3305H-150F
	8xD	1.299 - 1.496	11-59/64	14-5/64	16-3/4	2-11/16	1-1/2	1/4 NPT	⚠ W3308H-150F
	10xD	1.299 - 1.496	14-29/32	17-1/16	19-3/4	2-11/16	1-1/2	1/4 NPT	⚠ W3310H-150F
m	3xD	33.00 - 37.99	112.60	167.49	237.49	70.00	40.00	1/4 BSPT	W3303H-40FM
	5xD	33.00 - 37.99	188.60	243.41	313.41	70.00	40.00	1/4 BSPT	W3305H-40FM
	8xD	33.00 - 37.99	302.60	357.40	427.40	70.00	40.00	1/4 BSPT	⚠ W3308H-40FM
	10xD	33.00 - 37.99	378.61	433.40	503.40	70.00	40.00	1/4 BSPT	⚠ W3310H-40FM

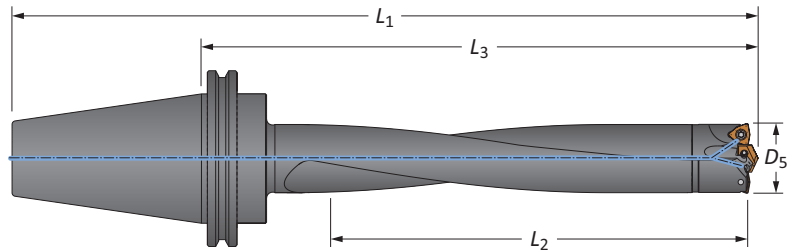

CAT Integral Shank

	Length	D ₅		Body			Shank	Part No.
		inch	mm	L ₂	L ₃	L ₁		
i	3xD	1.299 - 1.496	33.00 - 37.99	4-7/16	7-3/8	10-3/16	CV40	W3303H-CV40
	5xD	1.299 - 1.496	33.00 - 37.99	7-27/64	10-23/64	13-11/64	CV40	W3305H-CV40
	8xD	1.299 - 1.496	33.00 - 37.99	11-59/64	14-55/64	17-21/32	CV40	⚠ W3308H-CV40
	10xD	1.299 - 1.496	33.00 - 37.99	14-29/32	17-27/32	20-21/32	CV40	⚠ W3310H-CV40
	3xD	1.299 - 1.496	33.00 - 37.99	4-7/16	7-3/8	11-1/2	CV50	W3303H-CV50
	5xD	1.299 - 1.496	33.00 - 37.99	7-27/64	10-23/64	14-31/64	CV50	W3305H-CV50
	8xD	1.299 - 1.496	33.00 - 37.99	11-59/64	14-55/64	18-31/32	CV50	⚠ W3308H-CV50
	10xD	1.299 - 1.496	33.00 - 37.99	14-29/32	17-27/32	21-31/32	CV50	⚠ W3310H-CV50

Connection Accessories

Mounting Screw	Mounting Screw Driver	Admissible Tightening Torque*
75020-IP20-1	8IP-20	60 in-lb (678 N-cm)

*Tightening torques are calculated with a friction coefficient of $\mu = 0.14$ and develop 90% of ultimate yield strength

⚠ WARNING Refer to Speed and Feed charts for recommended adjustments to speeds and feeds. Refer to page A50: 30 for deep hole drilling guidelines in this section of the catalog. Visit www.alliedmachine.com/DeepHoleGuidelines for the most up-to-date information and procedures. Factory technical assistance is available for your specific applications through our Application Engineering Team.
ext: 7611 | email: appeng@alliedmachine.com

i = Imperial (in)
m = Metric (mm)



Mounting screws sold in multiples of 4

APX Drill Heads

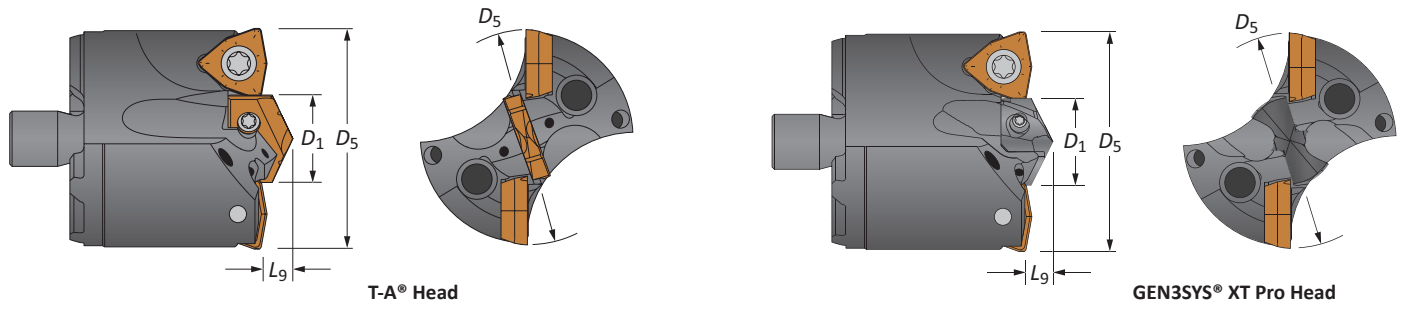
38 Series | Diameter Range: 1.496" - 1.732" (38.00 mm - 43.99 mm)





Heads

Head					T-A Head				GEN3SYS XT Pro Head			IC Insert Size	
D_5 fractional	D_5 inch	D_5 metric	D_1	L_9	Part No.	Pilot Series	 T-A Pro Insert	 T-A (TC) Insert	Part No.	Pilot Series	 Pilot Insert	inch	metric
-	1.496	38.00	5/8	19/64	V3800D-38	0	TA#0-15.88	1C10H-0020-TC	V3815D-38	15	XT#15-15.88	3/8	9.53
1-1/2	1.500	38.10	5/8	19/64	V3800D-0116	0	TA#0-15.88	1C10H-0020-TC	V3815D-0116	15	XT#15-15.88	3/8	9.53
1-17/32	1.531	38.90	5/8	19/64	V3800D-0117	0	TA#0-15.88	1C10H-0020-TC	V3815D-0117	15	XT#15-15.88	3/8	9.53
-	1.535	39.00	5/8	19/64	V3800D-39	0	TA#0-15.88	1C10H-0020-TC	V3815D-39	15	XT#15-15.88	3/8	9.53
1-9/16	1.563	39.69	5/8	19/64	V3800D-0118	0	TA#0-15.88	1C10H-0020-TC	V3815D-0118	15	XT#15-15.88	3/8	9.53
-	1.575	40.00	11/16	19/64	V3800D-40	0	TA#0-17.46	1C10H-0022-TC	V3817D-40	17	XT#17-17.46	3/8	9.53
1-19/32	1.594	40.48	11/16	19/64	V3800D-0119	0	TA#0-17.46	1C10H-0022-TC	V3817D-0119	17	XT#17-17.46	3/8	9.53
-	1.614	41.00	11/16	19/64	V3800D-41	0	TA#0-17.46	1C10H-0022-TC	V3817D-41	17	XT#17-17.46	3/8	9.53
1-5/8	1.625	41.28	11/16	19/64	V3800D-0120	0	TA#0-17.46	1C10H-0022-TC	V3817D-0120	17	XT#17-17.46	3/8	9.53
-	1.654	42.00	3/4	19/64	V3801D-42	1	TA#1-19.05	1C11H-0024-TC	V3818D-42	18	XT#18-19.05	3/8	9.53
1-21/32	1.656	42.07	3/4	19/64	V3801D-0121	1	TA#1-19.05	1C11H-0024-TC	V3818D-0121	18	XT#18-19.05	3/8	9.53
1-11/16	1.688	42.86	3/4	19/64	V3801D-0122	1	TA#1-19.05	1C11H-0024-TC	V3818D-0122	18	XT#18-19.05	3/8	9.53
-	1.693	43.00	13/16	19/64	V3801D-43	1	TA#1-20.64	1C11H-0026-TC	V3820D-43	20	XT#20-20.64	3/8	9.53
1-23/32	1.719	43.66	13/16	19/64	V3801D-0123	1	TA#1-20.64	1C11H-0026-TC	V3820D-0123	20	XT#20-20.64	3/8	9.53



#Denotes ISO material/geometry (P= steel, K= cast iron, N= nonferrous)

IC Inserts

Coating	Size		Grade	Geometry	 Part No.	 Insert Screw	 Insert Driver	Admissible Tightening Torque*
	inch	metric						
AM300®	3/8	9.53	C5 (P35)	Standard	OP-060408-PW	73595-IP15-1	8IP-15	41.0 in-lbs (465 N-cm)
AM300®	3/8	9.53	C1 (K35)	Standard	OP-060408-1PW	73595-IP15-1	8IP-15	41.0 in-lbs (465 N-cm)
AM300®	3/8	9.53	C2 (K25)	Standard	OP-060408-2PW	73595-IP15-1	8IP-15	41.0 in-lbs (465 N-cm)
AM300®	3/8	9.53	C5 (P35)	High Rake	OP-060408-PWHR	73595-IP15-1	8IP-15	41.0 in-lbs (465 N-cm)

*Tightening torques are calculated with a friction coefficient of $\mu = 0.14$ and develop 90% of ultimate yield strength

Pilot Accessories

Pilot Style	Series	 Insert Screws	 Insert Driver	Admissible Tightening Torque*
T-A	0	72567-IP8-1	8IP-8	15.5 in-lbs (175 N-cm)
T-A	1	7375-IP9-1	8IP-9	27.0 in-lbs (305 N-cm)
GEN3SYS	15	7247-IP7-1	8IP-7	7.4 in-lbs (84 N-cm)
GEN3SYS	17	72567-IP8-1	8IP-8	15.5 in-lbs (175 N-cm)
GEN3SYS	18	7375-IP9-1	8IP-9	27.0 in-lbs (305 N-cm)
GEN3SYS	20	7375-IP9-1	8IP-9	27.0 in-lbs (305 N-cm)

*Tightening torques are calculated with a friction coefficient of $\mu = 0.14$ and develop 90% of ultimate yield strength

A50: 28 - 29

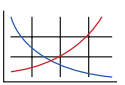

A50: 2 - 5



Section A20



Section A25 & A30

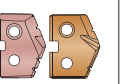

Nonstocked diameters are also available. Follow the examples shown below.

Inch	38 series, T-A (1 series), 1.6790"	Part No. = V3801D-1.6790
Metric	38 series, T-A (1 series), 42.15 mm	Part No. = V3801D-42.15

IC inserts sold in multiples of 2 | Insert screws sold in multiples of 10

APX Drill Holders

38 Series | Diameter Range: 1.496" - 1.732" (38.00 mm - 43.99 mm)

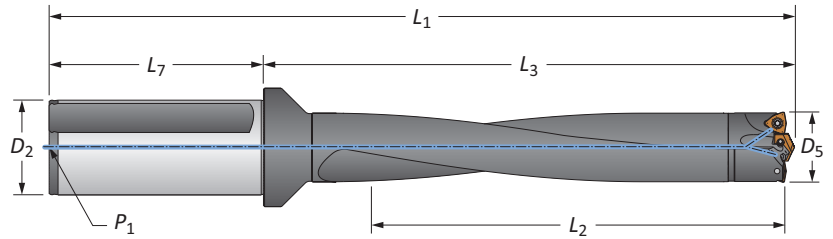

Straight Shank

Length	D ₅	Body			Shank			Part No.		
		L ₂	L ₃	L ₁	L ₇	D ₂	P ₁			
i	3xD	1.496 - 1.732	5-1/8	7-47/64	10-25/64	2-11/16	1-1/2	1/4 NPT	W3803H-150F	
	5xD	1.496 - 1.732	8-5/8	11-13/64	13-55/64	2-11/16	1-1/2	1/4 NPT	W3805H-150F	
	8xD	1.496 - 1.732	13-7/8	16-25/64	19-3/64	2-11/16	1-1/2	1/4 NPT	W3808H-150F	
	10xD	1.496 - 1.732	17-1/4	19-27/32	22-33/64	2-11/16	1-1/2	1/4 NPT	W3810H-150F	
	3xD	1.496 - 1.732	5-1/8	7-47/64	12-15/64	4-1/2	2	1/4 NPT	W3803H-200F	
	5xD	1.496 - 1.732	8-5/8	11-13/64	15-45/64	4-1/2	2	1/4 NPT	W3805H-200F	
	8xD	1.496 - 1.732	13-7/8	16-25/64	20-57/64	4-1/2	2	1/4 NPT	W3808H-200F	
	10xD	1.496 - 1.732	17-1/4	19-27/32	24-59/64	4-1/2	2	1/4 NPT	W3810H-200F	
	m	3xD	38.00 - 43.99	130.51	196.49	265.71	70.00	40.00	1/4 BSPT	W3803H-40FM
		5xD	38.00 - 43.99	219.99	284.51	353.70	70.00	40.00	1/4 BSPT	W3805H-40FM
8xD		38.00 - 43.99	351.99	416.51	485.70	70.00	40.00	1/4 BSPT	W3808H-40FM	
10xD		38.00 - 43.99	439.90	503.91	573.71	70.00	40.00	1/4 BSPT	W3810H-40FM	
3xD		38.00 - 43.99	130.51	196.49	276.50	80.00	50.00	1/4 BSPT	W3803H-50FM	
5xD		38.00 - 43.99	219.99	284.51	364.49	80.00	50.00	1/4 BSPT	W3805H-50FM	
8xD		38.00 - 43.99	351.99	416.51	496.99	80.00	50.00	1/4 BSPT	W3808H-50FM	
10xD		38.00 - 43.99	439.90	503.90	583.91	80.00	50.00	1/4 BSPT	W3810H-50FM	

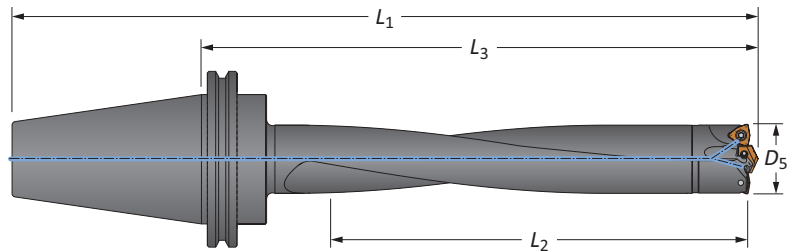

CAT Integral Shank

Length	D ₅		Body			Shank	Part No.	
	inch	mm	L ₂	L ₃	L ₁			
i	3xD	1.496 - 1.732	38.00 - 43.99	5-1/8	8-5/16	11	CV40	W3803H-CV40
	5xD	1.496 - 1.732	38.00 - 43.99	8-5/8	11-49/64	14-29/64	CV40	W3805H-CV40
	8xD	1.496 - 1.732	38.00 - 43.99	13-7/8	16-31/32	19-21/32	CV40	W3808H-CV40
	10xD	1.496 - 1.732	38.00 - 43.99	17-1/4	20-7/16	23-1/8	CV40	W3810H-CV40
	3xD	1.496 - 1.732	38.00 - 43.99	5-1/8	8-5/16	12-5/16	CV50	W3803H-CV50
	5xD	1.496 - 1.732	38.00 - 43.99	8-5/8	11-49/64	15-49/64	CV50	W3805H-CV50
	8xD	1.496 - 1.732	38.00 - 43.99	13-7/8	16-31/32	20-31/32	CV50	W3808H-CV50
	10xD	1.496 - 1.732	38.00 - 43.99	17-1/4	20-7/16	24-7/16	CV50	W3810H-CV50

Connection Accessories

Mounting Screw	Mounting Screw Driver	Admissible Tightening Torque*
75020-IP20-1	8IP-20	60 in-lb (678 N-cm)

*Tightening torques are calculated with a friction coefficient of $\mu = 0.14$ and develop 90% of ultimate yield strength

⚠ WARNING Refer to Speed and Feed charts for recommended adjustments to speeds and feeds. Refer to page A50: 30 for deep hole drilling guidelines in this section of the catalog. Visit www.alliedmachine.com/DeepHoleGuidelines for the most up-to-date information and procedures. Factory technical assistance is available for your specific applications through our Application Engineering Team.
ext: 7611 | email: appeng@alliedmachine.com

i = Imperial (in)
m = Metric (mm)



Mounting screws sold in multiples of 4

APX Drill Heads

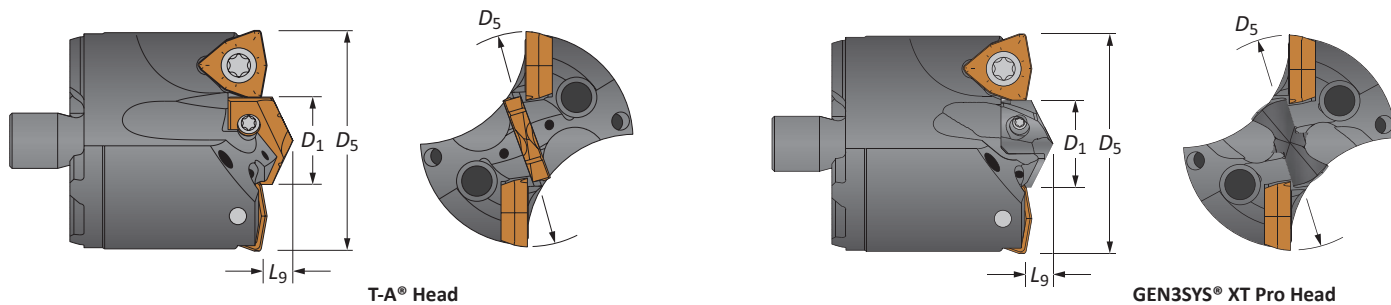
44 Series | Diameter Range: 1.732" - 2.008" (44.00 mm - 50.99 mm)





Heads

Head					T-A Head				GEN3SYS XT Pro Head			IC Insert Size	
D ₅ fractional	D ₅ inch	D ₅ metric	D ₁	L ₉	Part No.	Pilot Series			Part No.	Pilot Series		inch	metric
-	1.732	44.00	7/8	21/64	V4401D-44	1	TA#1-22.23	1C11H-0028-TC	V4422D-44	22	XT#22-22.23	3/8	9.53
1-3/4	1.750	44.45	7/8	21/64	V4401D-0124	1	TA#1-22.23	1C11H-0028-TC	V4422D-0124	22	XT#22-22.23	3/8	9.53
-	1.772	45.00	7/8	21/64	V4401D-45	1	TA#1-22.23	1C11H-0028-TC	V4422D-45	22	XT#22-22.23	3/8	9.53
1-25/32	1.781	45.25	7/8	21/64	V4401D-0125	1	TA#1-22.23	1C11H-0028-TC	V4422D-0125	22	XT#22-22.23	3/8	9.53
-	1.811	46.00	15/16	21/64	V4401D-46	1	TA#1-23.81	1C11H-0030-TC	V4422D-46	22	XT#22-23.81	3/8	9.53
1-13/16	1.813	46.04	15/16	21/64	V4401D-0126	1	TA#1-23.81	1C11H-0030-TC	V4422D-0126	22	XT#22-23.81	3/8	9.53
1-27/32	1.844	46.83	15/16	21/64	V4401D-0127	1	TA#1-23.81	1C11H-0030-TC	V4422D-0127	22	XT#22-23.81	3/8	9.53
-	1.850	47.00	15/16	21/64	V4401D-47	1	TA#1-23.81	1C11H-0030-TC	V4422D-47	22	XT#22-23.81	3/8	9.53
1-7/8	1.875	47.63	15/16	21/64	V4401D-0128	1	TA#1-23.81	1C11H-0030-TC	V4422D-0128	22	XT#22-23.81	3/8	9.53
-	1.890	48.00	45/64	21/64	V4401D-48	1**	TA#1-17.86	1C11H-703-TC	V4417D-48	17	XT#17-17.86	1/2	12.70
1-29/32	1.906	48.42	45/64	21/64	V4401D-0129	1**	TA#1-17.86	1C11H-703-TC	V4417D-0129	17	XT#17-17.86	1/2	12.70
-	1.929	49.00	45/64	21/64	V4401D-49	1**	TA#1-17.86	1C11H-703-TC	V4417D-49	17	XT#17-17.86	1/2	12.70
1-15/16	1.938	49.21	45/64	21/64	V4401D-0130	1**	TA#1-17.86	1C11H-703-TC	V4417D-0130	17	XT#17-17.86	1/2	12.70
-	1.969	50.00	47/64	21/64	V4401D-50	1**	TA#1-18.65	1C11H-734-TC	V4418D-50	18	XT#18-18.65	1/2	12.70
1-31/32	1.969	50.01	47/64	21/64	V4401D-0131	1**	TA#1-18.65	1C11H-734-TC	V4418D-0131	18	XT#18-18.65	1/2	12.70
2	2.000	50.80	47/64	21/64	V4401D-0200	1**	TA#1-18.65	1C11H-734-TC	V4418D-0200	18	XT#18-18.65	1/2	12.70



#Denotes ISO material/geometry (P= steel, K= cast iron, N= nonferrous)

IC Inserts



Coating	Size		Grade	Geometry	 Part No.	 Insert Screw	 Insert Driver	Admissible Tightening Torque*
	inch	metric						
AM300®	3/8	9.53	C5 (P35)	Standard	OP-060408-PW	73595-IP15-1	8IP-15	41.0 in-lbs (465 N-cm)
AM300®	3/8	9.53	C1 (K35)	Standard	OP-060408-1PW	73595-IP15-1	8IP-15	41.0 in-lbs (465 N-cm)
AM300®	3/8	9.53	C2 (K25)	Standard	OP-060408-2PW	73595-IP15-1	8IP-15	41.0 in-lbs (465 N-cm)
AM300®	3/8	9.53	C5 (P35)	High Rake	OP-060408-PWHR	73595-IP15-1	8IP-15	41.0 in-lbs (465 N-cm)
AM300®	1/2	12.70	C5 (P35)	Standard	OP-080508-PW	74012-IP15-1	8IP-15	61.0 in-lbs (690 N-cm)
AM300®	1/2	12.70	C1 (K35)	Standard	OP-080508-1PW	74012-IP15-1	8IP-15	61.0 in-lbs (690 N-cm)
AM300®	1/2	12.70	C2 (K25)	Standard	OP-080508-2PW	74012-IP15-1	8IP-15	61.0 in-lbs (690 N-cm)
AM300®	1/2	12.70	C5 (P35)	High Rake	OP-080508-PWHR	74012-IP15-1	8IP-15	61.0 in-lbs (690 N-cm)

*Tightening torques are calculated with a friction coefficient of $\mu = 0.14$ and develop 90% of ultimate yield strength

Pilot Accessories

Pilot Style	Series	 Insert Screws	 Insert Driver	Admissible Tightening Torque*
T-A	1	739-IP9-1	8IP-9	27.0 in-lbs (305 N-cm)
T-A	1**	7375-IP9-1	8IP-9	27.0 in-lbs (305 N-cm)
GEN3SYS	17	72567-IP8-1	8IP-8	15.5 in-lbs (175 N-cm)
GEN3SYS	18	7375-IP9-1	8IP-9	27.0 in-lbs (305 N-cm)
GEN3SYS	22	739-IP9-1	8IP-9	27.0 in-lbs (305 N-cm)

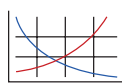
*Tightening torques are calculated with a friction coefficient of $\mu = 0.14$ and develop 90% of ultimate yield strength

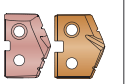
A50: 28 - 29  A50: 2 - 5  Section A20  Section A25 & A30 

Nonstocked diameters are also available. Follow the examples shown below.

Inch	38 series, T-A (1 series), 1.6790"	Part No. = V3801D-1.6790
Metric	38 series, T-A (1 series), 42.15 mm	Part No. = V3801D-42.15

IC inserts sold in multiples of 2 | Insert screws sold in multiples of 10

APX Drill Holders

44 Series | Diameter Range: 1.732" - 2.008" (44.00 mm - 50.99 mm)

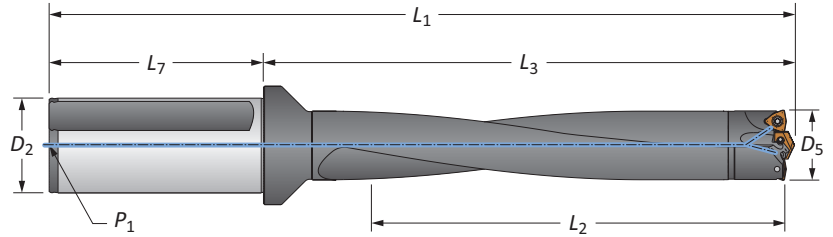

Straight Shank

Length	D ₅	Body			Shank			Part No.	
		L ₂	L ₃	L ₁	L ₇	D ₂	P ₁		
i	3xD	1.732 - 2.008	6	8-17/32	11-15/64	2-11/16	1-1/2	1/4 NPT	W4403H-150F
	5xD	1.732 - 2.008	10	12-35/64	15-1/4	2-11/16	1-1/2	1/4 NPT	W4405H-150F
	8xD	1.732 - 2.008	16	18-37/64	21-17/64	2-11/16	1-1/2	1/4 NPT	W4408H-150F
	10xD	1.732 - 2.008	20-1/8	22-19/32	25-9/32	2-11/16	1-1/2	1/4 NPT	W4410H-150F
	3xD	1.732 - 2.008	6	8-33/64	13-1/32	4-1/2	2	1/4 NPT	W4403H-200F
	5xD	1.732 - 2.008	10	12-35/64	17-3/64	4-1/2	2	1/4 NPT	W4405H-200F
	8xD	1.732 - 2.008	16	18-37/64	23-5/64	4-1/2	2	1/4 NPT	W4408H-200F
	10xD	1.732 - 2.008	20-1/8	22-19/32	27-3/32	4-1/2	2	1/4 NPT	W4410H-200F
m	3xD	44.00 - 50.99	152.00	216.79	286.89	70.00	40.00	1/4 BSPT	W4403H-40FM
	5xD	44.00 - 50.99	255.00	318.80	388.90	70.00	40.00	1/4 BSPT	W4405H-40FM
	8xD	44.00 - 50.99	408.00	471.81	541.81	70.00	40.00	1/4 BSPT	W4408H-40FM
	10xD	44.00 - 50.99	510.01	573.81	643.79	70.00	40.00	1/4 BSPT	W4410H-40FM
	3xD	44.00 - 50.99	152.00	216.79	296.90	80.00	50.00	1/4 BSPT	W4403H-50FM
	5xD	44.00 - 50.99	255.00	318.80	398.80	80.00	50.00	1/4 BSPT	W4405H-50FM
	8xD	44.00 - 50.99	409.00	471.70	551.69	80.00	50.00	1/4 BSPT	W4408H-50FM
	10xD	44.00 - 50.99	510.01	573.81	653.80	80.00	50.00	1/4 BSPT	W4410H-50FM

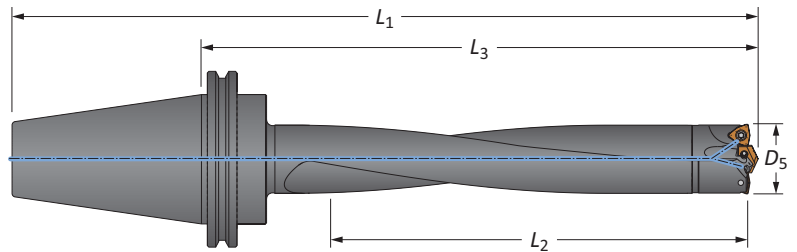

CAT Integral Shank

Length	D ₅		Body			Shank	Part No.	
	inch	mm	L ₂	L ₃	L ₁			
i	3xD	1.732 - 2.008	44.00 - 50.99	6	9-1/4	11-15/16	CV40	W4403H-CV40
	5xD	1.732 - 2.008	44.00 - 50.99	10	13-17/64	15-61/64	CV40	W4405H-CV40
	8xD	1.732 - 2.008	44.00 - 50.99	16	19-19/64	21-63/64	CV40	W4408H-CV40
	10xD	1.732 - 2.008	44.00 - 50.99	20-1/8	23-5/16	26	CV40	W4410H-CV40
	3xD	1.732 - 2.008	44.00 - 50.99	6	9-1/4	13-1/4	CV50	W4403H-CV50
	5xD	1.732 - 2.008	44.00 - 50.99	10	13-17/64	17-17/64	CV50	W4405H-CV50
	8xD	1.732 - 2.008	44.00 - 50.99	16	19-19/64	23-19/64	CV50	W4408H-CV50
	10xD	1.732 - 2.008	44.00 - 50.99	20	23-5/16	27-5/16	CV50	W4410H-CV50

Connection Accessories

		Admissible Tightening Torque*
Mounting Screw 75020-IP20-1	Mounting Screw Driver 8IP-20	
		60 in-lb (678 N-cm)

*Tightening torques are calculated with a friction coefficient of $\mu = 0.14$ and develop 90% of ultimate yield strength

⚠ WARNING Refer to Speed and Feed charts for recommended adjustments to speeds and feeds. Refer to page A50: 30 for deep hole drilling guidelines in this section of the catalog. Visit www.alliedmachine.com/DeepHoleGuidelines for the most up-to-date information and procedures. Factory technical assistance is available for your specific applications through our Application Engineering Team.
ext: 7611 | email: appeng@alliedmachine.com

i = Imperial (in)
m = Metric (mm)

Mounting screws sold in multiples of 4

APX Drill Heads

51 Series | Diameter Range: 2.008" - 2.244" (51.00 mm - 56.99 mm)

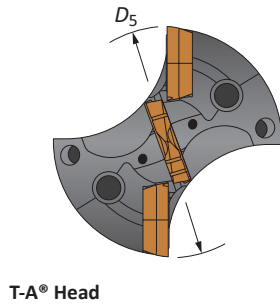
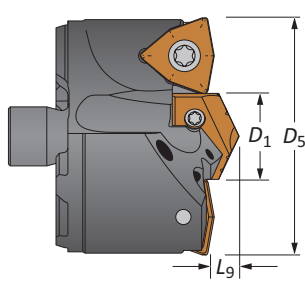

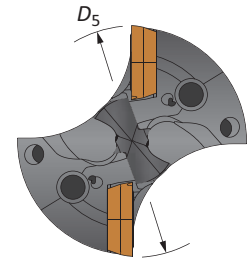
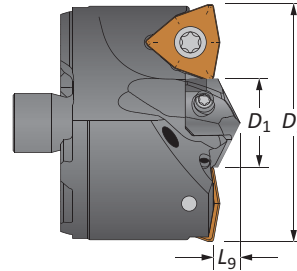

T-A® Head





GEN3SYS® XT Pro Head

Heads

Head					T-A Head				GEN3SYS XT Pro Head			IC Insert Size	
D_5 fractional	D_5 inch	D_5 metric	D_1	L_9	Part No.	Pilot Series			Part No.	Pilot Series		inch	metric
-	2.008	51.00	25/32	11/32	V5101D-51	1**	TA#1-19.84	1C11H-0025-TC	V5118D-51	18	XT#18-19.84	1/2	12.70
2-1/32	2.031	51.59	25/32	11/32	V5101D-0201	1**	TA#1-19.84	1C11H-0025-TC	V5118D-0201	18	XT#18-19.84	1/2	12.70
-	2.047	52.00	25/32	11/32	V5101D-52	1**	TA#1-19.84	1C11H-0025-TC	V5118D-52	18	XT#18-19.84	1/2	12.70
2-1/16	2.063	52.39	25/32	11/32	V5101D-0202	1**	TA#1-19.84	1C11H-0025-TC	V5118D-0202	18	XT#18-19.84	1/2	12.70
-	2.087	53.00	27/32	11/32	V5101D-53	1**	TA#1-21.43	1C11H-0027-TC	V5120D-53	20	XT#20-21.43	1/2	12.70
2-3/32	2.094	53.18	27/32	11/32	V5101D-0203	1**	TA#1-21.43	1C11H-0027-TC	V5120D-0203	20	XT#20-21.43	1/2	12.70
2-1/8	2.125	53.98	27/32	11/32	V5101D-0204	1**	TA#1-21.43	1C11H-0027-TC	V5120D-0204	20	XT#20-21.43	1/2	12.70
-	2.126	54.00	15/16	11/32	V5101D-54	1	TA#1-23.81	1C11H-0030-TC	V5122D-54	22	XT#22-23.81	1/2	12.70
2-5/32	2.156	54.77	15/16	11/32	V5101D-0205	1	TA#1-23.81	1C11H-0030-TC	V5122D-0205	22	XT#22-23.81	1/2	12.70
-	2.165	55.00	15/16	11/32	V5101D-55	1	TA#1-23.81	1C11H-0030-TC	V5122D-55	22	XT#22-23.81	1/2	12.70
2-3/16	2.188	55.56	15/16	11/32	V5101D-0206	1	TA#1-23.81	1C11H-0030-TC	V5122D-0206	22	XT#22-23.81	1/2	12.70
-	2.205	56.00	15/16	11/32	V5101D-56	1	TA#1-23.81	1C11H-0030-TC	V5122D-56	22	XT#22-23.81	1/2	12.70
2-7/32	2.219	56.36	13/16	11/32	V5101D-0207	1**	TA#1-20.64	1C11H-0026-TC	V5120D-0207	20	XT#20-20.64	9/16	14.29



#Denotes ISO material/geometry (P= steel, K= cast iron, N= nonferrous)

IC Inserts

Coating	Size		Grade	Geometry	 Part No.	 Insert Screw	 Insert Driver	Admissible Tightening Torque*
	inch	metric						
AM300®	1/2	12.70	C5 (P35)	Standard	OP-080508-PW	74012-IP15-1	8IP-15	61.0 in-lbs (690 N-cm)
AM300®	1/2	12.70	C1 (K35)	Standard	OP-080508-1PW	74012-IP15-1	8IP-15	61.0 in-lbs (690 N-cm)
AM300®	1/2	12.70	C2 (K25)	Standard	OP-080508-2PW	74012-IP15-1	8IP-15	61.0 in-lbs (690 N-cm)
AM300®	1/2	12.70	C5 (P35)	High Rake	OP-080508-PWHR	74012-IP15-1	8IP-15	61.0 in-lbs (690 N-cm)
AM300®	9/16	14.29	C5 (P35)	Standard	OP-090608-PW	75014-IP20-1	8IP-20	121.0 in-lbs (1370 N-cm)
AM300®	9/16	14.29	C1 (K35)	Standard	OP-090608-1PW	75014-IP20-1	8IP-20	121.0 in-lbs (1370 N-cm)
AM300®	9/16	14.29	C2 (K25)	Standard	OP-090608-2PW	75014-IP20-1	8IP-20	121.0 in-lbs (1370 N-cm)
AM300®	9/16	14.29	C5 (P35)	High Rake	OP-090608-PWHR	75014-IP20-1	8IP-20	121.0 in-lbs (1370 N-cm)

*Tightening torques are calculated with a friction coefficient of $\mu = 0.14$ and develop 90% of ultimate yield strength

Pilot Accessories

Pilot Style	Series	 Insert Screws	 Insert Driver	Admissible Tightening Torque*
T-A	1	739-IP9-1	8IP-9	27.0 in-lbs (305 N-cm)
T-A	1**	7375-IP9-1	8IP-9	27.0 in-lbs (305 N-cm)
GEN3SYS	18	7375-IP9-1	8IP-9	27.0 in-lbs (305 N-cm)
GEN3SYS	20	7375-IP9-1	8IP-9	27.0 in-lbs (305 N-cm)
GEN3SYS	22	739-IP9-1	8IP-9	27.0 in-lbs (305 N-cm)

*Tightening torques are calculated with a friction coefficient of $\mu = 0.14$ and develop 90% of ultimate yield strength

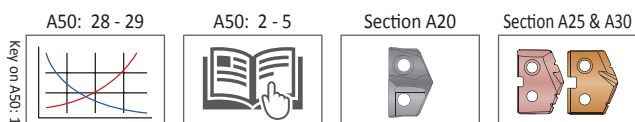

Nonstocked diameters are also available. Follow the examples shown below.

Inch	38 series, T-A (1 series), 1.6790"	Part No. = V3801D-1.6790
Metric	38 series, T-A (1 series), 42.15 mm	Part No. = V3801D-42.15

IC inserts sold in multiples of 2 | Insert screws sold in multiples of 10



APX Drill Holders

51 Series | Diameter Range: 2.008" - 2.244" (51.00 mm - 56.99 mm)

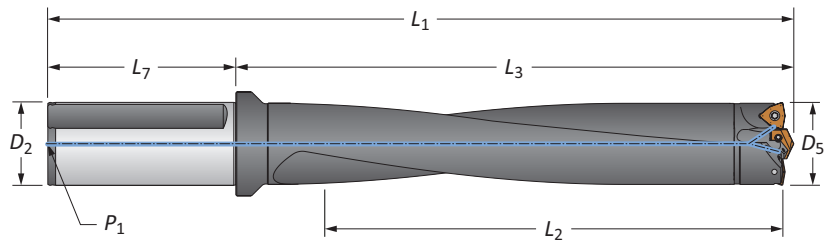

Straight Shank

	Length	Body				Shank			Part No.
		D ₅	L ₂	L ₃	L ₁	L ₇	D ₂	P ₁	
i	3xD	2.008 - 2.244	6-3/8	8-7/8	13-3/8	4-1/2	2	1/4 NPT	W5103H-200F
	5xD	2.008 - 2.244	11-1/8	13-3/8	17-7/8	4-1/2	2	1/4 NPT	W5105H-200F
	8xD	2.008 - 2.244	17-7/8	20-3/32	24-19/32	4-1/2	2	1/4 NPT	⚠ W5108H-200F
	10xD	2.008 - 2.244	22-3/8	24-19/32	29-3/32	4-1/2	2	1/4 NPT	⚠ W5110H-200F
m	3xD	51.00 - 56.99	161.80	225.50	305.51	80.00	50.00	1/4 BSPT	W5103H-50FM
	5xD	51.00 - 56.99	284.99	339.60	419.61	80.00	50.00	1/4 BSPT	W5105H-50FM
	8xD	51.00 - 56.99	455.90	510.49	590.50	80.00	50.00	1/4 BSPT	⚠ W5108H-50FM
	10xD	51.00 - 56.99	570.00	624.61	704.60	80.00	50.00	1/4 BSPT	⚠ W5110H-50FM

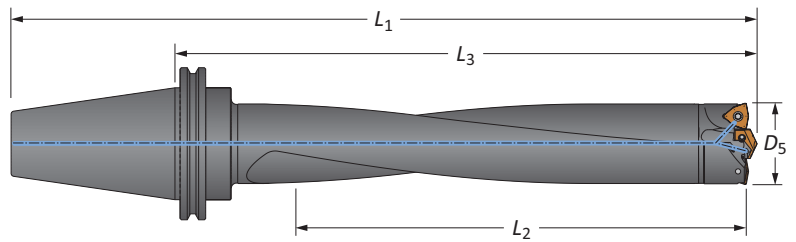

CV50 Shank

	Length	D ₅		Body			Shank	Part No.
		inch	mm	L ₂	L ₃	L ₁		
i	3xD	2.008 - 2.244	51.00 - 56.99	6-3/8	9-47/64	13-47/64	CV50	W5103H-CV50
	5xD	2.008 - 2.244	51.00 - 56.99	11-1/4	14-7/32	18-7/32	CV50	W5105H-CV50
	8xD	2.008 - 2.244	51.00 - 56.99	17-7/8	20-61/64	24-61/64	CV50	⚠ W5108H-CV50
	10xD	2.008 - 2.244	51.00 - 56.99	22-3/8	25-7/16	29-7/16	CV50	⚠ W5110H-CV50

Connection Accessories

Mounting Screw	Mounting Screw Driver	Admissible Tightening Torque*
75020-IP20-1	8IP-20	60 in-lb (678 N-cm)

*Tightening torques are calculated with a friction coefficient of $\mu = 0.14$ and develop 90% of ultimate yield strength

⚠ WARNING Refer to Speed and Feed charts for recommended adjustments to speeds and feeds. Refer to page A50: 30 for deep hole drilling guidelines in this section of the catalog. Visit www.alliedmachine.com/DeepHoleGuidelines for the most up-to-date information and procedures. Factory technical assistance is available for your specific applications through our Application Engineering Team.
ext: 7611 | email: appeng@alliedmachine.com

i = Imperial (in)
m = Metric (mm)

Mounting screws sold in multiples of 4

APX Drill Heads

57 Series | Diameter Range: 2.244" - 2.480" (57.00 mm - 62.99 mm)

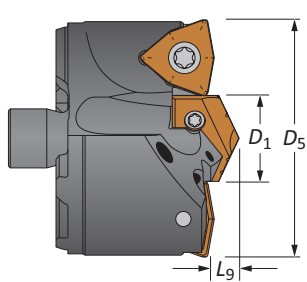

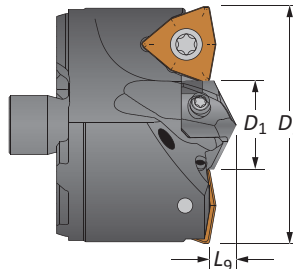
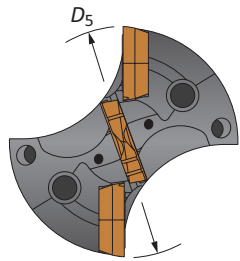

T-A® Head

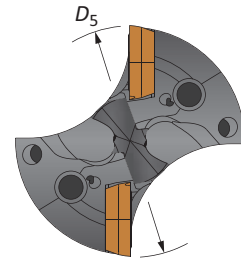

GEN3SYS® XT Pro Head





Heads

Head					T-A Head				GEN3SYS XT Pro Head			IC Insert Size	
D ₅ fractional	D ₅ inch	D ₅ metric	D ₁	L ₉	Part No.	Pilot Series			Part No.	Pilot Series		inch	metric
-	2.244	57.00	29/32	25/64	V5701D-57	1	TA#1-23.02	1C11H-0029-TC	V5722D-57	22	XT#22-23.02	9/16	14.29
2-1/4	2.250	57.15	29/32	25/64	V5701D-0208	1	TA#1-23.02	1C11H-0029-TC	V5722D-0208	22	XT#22-23.02	9/16	14.29
2-9/32	2.281	57.94	29/32	25/64	V5701D-0209	1	TA#1-23.02	1C11H-0029-TC	V5722D-0209	22	XT#22-23.02	9/16	14.29
-	2.284	58.00	29/32	25/64	V5701D-58	1	TA#1-23.02	1C11H-0029-TC	V5722D-58	22	XT#22-23.02	9/16	14.29
2-5/16	2.313	58.74	29/32	25/64	V5701D-0210	1	TA#1-23.02	1C11H-0029-TC	V5722D-0210	22	XT#22-23.02	9/16	14.29
-	2.323	59.00	15/16	25/64	V5701D-59	1	TA#1-23.81	1C11H-0030-TC	V5722D-59	22	XT#22-23.81	9/16	14.29
2-11/32	2.344	59.53	15/16	25/64	V5701D-0211	1	TA#1-23.81	1C11H-0030-TC	V5722D-0211	22	XT#22-23.81	9/16	14.29
-	2.362	60.00	15/16	25/64	V5701D-60	1	TA#1-23.81	1C11H-0030-TC	V5722D-60	22	XT#22-23.81	9/16	14.29
2-3/8	2.375	60.33	15/16	25/64	V5701D-0212	1	TA#1-23.81	1C11H-0030-TC	V5722D-0212	22	XT#22-23.81	9/16	14.29
-	2.402	61.00	1	25/64	V5702D-61	2	TA#2-25.40	1C12H-0100-TC	V5724D-61	24	XT#24-25.40	9/16	14.29
2-13/32	2.406	61.12	1	25/64	V5702D-0213	2	TA#2-25.40	1C12H-0100-TC	V5724D-0213	24	XT#24-25.40	9/16	14.29
2-7/16	2.438	61.91	1	25/64	V5702D-0214	2	TA#2-25.40	1C12H-0100-TC	V5724D-0214	24	XT#24-25.40	9/16	14.29
-	2.441	62.00	1-1/16	25/64	V5702D-62	2	TA#2-26.99	1C12H-0102-TC	V5726D-62	26	XT#26-26.99	9/16	14.29
2-15/32	2.469	62.71	1-1/16	25/64	V5702D-0215	2	TA#2-26.99	1C12H-0102-TC	V5726D-0215	26	XT#26-26.99	9/16	14.29

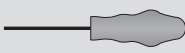

#Denotes ISO material/geometry (P= steel, K= cast iron, N= nonferrous)

IC Inserts

Coating	Size		Grade	Geometry	 Part No.	 Insert Screw	 Insert Driver	Admissible Tightening Torque*
	inch	metric						
AM300®	9/16	14.29	C5 (P35)	Standard	OP-090608-PW	75014-IP20-1	8IP-20	121.0 in-lbs (1370 N-cm)
AM300®	9/16	14.29	C1 (K35)	Standard	OP-090608-1PW	75014-IP20-1	8IP-20	121.0 in-lbs (1370 N-cm)
AM300®	9/16	14.29	C2 (K25)	Standard	OP-090608-2PW	75014-IP20-1	8IP-20	121.0 in-lbs (1370 N-cm)
AM300®	9/16	14.29	C5 (P35)	High Rake	OP-090608-PWHR	75014-IP20-1	8IP-20	121.0 in-lbs (1370 N-cm)

*Tightening torques are calculated with a friction coefficient of $\mu = 0.14$ and develop 90% of ultimate yield strength

Pilot Accessories

Pilot Style	Series	 Insert Screws	 Insert Driver	Admissible Tightening Torque*
T-A	1	739-IP9-1	8IP-9	27.0 in-lbs (305 N-cm)
T-A	2	7495-IP15-1	8IP-15	61.0 in-lbs (690 N-cm)
GEN3SYS	22	739-IP9-1	8IP-9	27.0 in-lbs (305 N-cm)
GEN3SYS	24	739-IP9-1	8IP-9	27.0 in-lbs (305 N-cm)
GEN3SYS	26	7495-IP15-1	8IP-15	61.0 in-lbs (690 N-cm)

*Tightening torques are calculated with a friction coefficient of $\mu = 0.14$ and develop 90% of ultimate yield strength

A50: 28 - 29

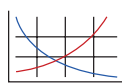

A50: 2 - 5



Section A20



Section A25 & A30

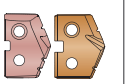

Nonstocked diameters are also available. Follow the examples shown below.

Inch	38 series, T-A (1 series), 1.6790"	Part No. = V3801D-1.6790
Metric	38 series, T-A (1 series), 42.15 mm	Part No. = V3801D-42.15

IC inserts sold in multiples of 2 | Insert screws sold in multiples of 10

A DRILLING
B BORING
C REAMING
D BURNISHING
E THREADING
X SPECIALS

APX Drill Holders

57 Series | Diameter Range: 2.244" - 2.480" (57.00 mm - 62.99 mm)

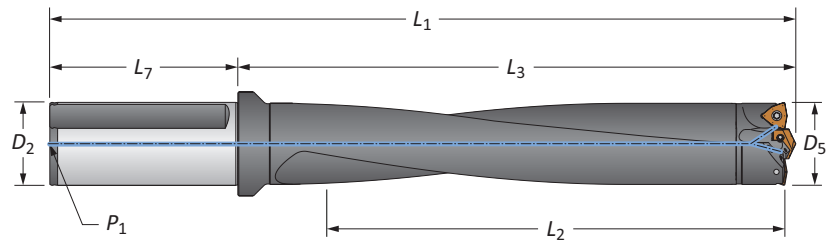

Straight Shank

	Length	Body				Shank			Part No.
		D ₅	L ₂	L ₃	L ₁	L ₇	D ₂	P ₁	
i	3xD	2.244 - 2.480	7-1/8	9-35/64	14-1/16	4-1/2	2	1/4 NPT	W5703H-200F
	5xD	2.244 - 2.480	12-3/8	14-33/64	19-1/64	4-1/2	2	1/4 NPT	W5705H-200F
	8xD	2.244 - 2.480	19-3/4	21-31/32	26-15/32	4-1/2	2	1/4 NPT	W5708H-200F
	10xD	2.244 - 2.480	24-3/4	26-59/64	31-27/64	4-1/2	2	1/4 NPT	W5710H-200F
m	3xD	57.00 - 62.99	179.91	242.70	322.71	80.00	50.00	1/4 BSPT	W5703H-50FM
	5xD	57.00 - 62.99	315.01	368.60	448.59	80.00	50.00	1/4 BSPT	W5705H-50FM
	8xD	57.00 - 62.99	503.90	557.81	637.81	80.00	50.00	1/4 BSPT	W5708H-50FM
	10xD	57.00 - 62.99	626.90	683.79	763.80	80.00	50.00	1/4 BSPT	W5710H-50FM

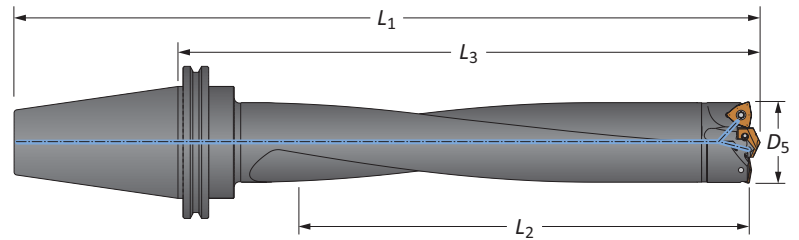

CV50 Shank

	Length	D ₅		Body			Shank	Part No.
		inch	mm	L ₂	L ₃	L ₁		
i	3xD	2.244 - 2.480	57.00 - 62.99	7-1/8	10-17/32	14-17/32	CV50	W5703H-CV50
	5xD	2.244 - 2.480	57.00 - 62.99	12-3/8	15-31/64	19-31/64	CV50	W5705H-CV50
	8xD	2.244 - 2.480	57.00 - 62.99	19-7/8	22-15/16	26-15/16	CV50	W5708H-CV50
	10xD	2.244 - 2.480	57.00 - 62.99	24-3/4	27-57/64	31-57/64	CV50	W5710H-CV50

Connection Accessories

Mounting Screw	Mounting Screw Driver	Admissible Tightening Torque*
75020-IP20-1	8IP-20	60 in-lb (678 N-cm)

*Tightening torques are calculated with a friction coefficient of $\mu = 0.14$ and develop 90% of ultimate yield strength

⚠ WARNING Refer to Speed and Feed charts for recommended adjustments to speeds and feeds. Refer to page A50: 30 for deep hole drilling guidelines in this section of the catalog. Visit www.alliedmachine.com/DeepHoleGuidelines for the most up-to-date information and procedures. Factory technical assistance is available for your specific applications through our Application Engineering Team.
ext: 7611 | email: appeng@alliedmachine.com

i = Imperial (in)
m = Metric (mm)



Mounting screws sold in multiples of 4

APX Drill Heads

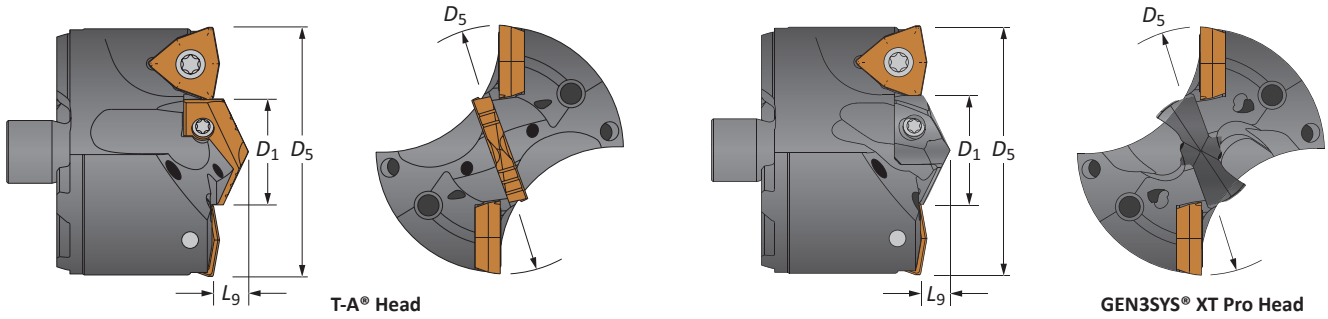
63 Series | Diameter Range: 2.480" - 2.756" (63.00 mm - 69.99 mm)





Heads

Head					T-A Head				GEN3SYS XT Pro Head			IC Insert Size	
D_5 fractional	D_5 inch	D_5 metric	D_1	L_9	Part No.	Pilot Series			Part No.	Pilot Series		inch	metric
-	2.480	63.00	1-1/8	7/16	V6302D-63	2	TA#2-28.58	1C12H-0104-TC	V6326D-63	26	XT#26-28.58	9/16	14.29
2-1/2	2.500	63.50	1-1/8	7/16	V6302D-0216	2	TA#2-28.58	1C12H-0104-TC	V6326D-0216	26	XT#26-28.58	9/16	14.29
-	2.520	64.00	1-1/8	7/16	V6302D-64	2	TA#2-28.58	1C12H-0104-TC	V6326D-64	26	XT#26-28.58	9/16	14.29
2-17/32	2.531	64.29	1-1/8	7/16	V6302D-0217	2	TA#2-28.58	1C12H-0104-TC	V6326D-0217	26	XT#26-28.58	9/16	14.29
-	2.559	65.00	1-1/8	7/16	V6302D-65	2	TA#2-28.58	1C12H-0104-TC	V6326D-65	26	XT#26-28.58	9/16	14.29
2-9/16	2.563	65.09	1-3/16	7/16	V6302D-0218	2	TA#2-30.16	1C12H-0106-TC	V6329D-0218	29	XT#29-30.16	9/16	14.29
2-19/32	2.594	65.88	1-3/16	7/16	V6302D-0219	2	TA#2-30.16	1C12H-0106-TC	V6329D-0219	29	XT#29-30.16	9/16	14.29
-	2.598	66.00	1-3/16	7/16	V6302D-66	2	TA#2-30.16	1C12H-0106-TC	V6329D-66	29	XT#29-30.16	9/16	14.29
2-5/8	2.625	66.68	1-3/16	7/16	V6302D-0220	2	TA#2-30.16	1C12H-0106-TC	V6329D-0220	29	XT#29-30.16	9/16	14.29
-	2.638	67.00	1-1/4	7/16	V6302D-67	2	TA#2-31.75	1C12H-0108-TC	V6329D-67	29	XT#29-31.75	9/16	14.29
2-21/32	2.656	67.47	1-1/4	7/16	V6302D-0221	2	TA#2-31.75	1C12H-0108-TC	V6329D-0221	29	XT#29-31.75	9/16	14.29
-	2.677	68.00	1-1/4	7/16	V6302D-68	2	TA#2-31.75	1C12H-0108-TC	V6329D-68	29	XT#29-31.75	9/16	14.29
2-11/16	2.688	68.26	1-1/4	7/16	V6302D-0222	2	TA#2-31.75	1C12H-0108-TC	V6329D-0222	29	XT#29-31.75	9/16	14.29
-	2.717	69.00	1-5/16	7/16	V6302D-69	2	TA#2-33.34	1C12H-0110-TC	V6332D-69	32	XT#32-33.34	9/16	14.29
2-23/32	2.719	69.06	1-5/16	7/16	V6302D-0223	2	TA#2-33.34	1C12H-0110-TC	V6332D-0223	32	XT#32-33.34	9/16	14.29
2-3/4	2.750	69.85	1-5/16	7/16	V6302D-0224	2	TA#2-33.34	1C12H-0110-TC	V6332D-0224	32	XT#32-33.34	9/16	14.29



#Denotes ISO material/geometry (P= steel, K= cast iron, N= nonferrous)

IC Inserts

Coating	Size		Grade	Geometry	 Part No.	 Insert Screw	 Insert Driver	Admissible Tightening Torque*
	inch	metric						
AM300®	9/16	14.29	C5 (P35)	Standard	OP-090608-PW	75014-IP20-1	8IP-20	121.0 in-lbs (1370 N-cm)
AM300®	9/16	14.29	C1 (K35)	Standard	OP-090608-1PW	75014-IP20-1	8IP-20	121.0 in-lbs (1370 N-cm)
AM300®	9/16	14.29	C2 (K25)	Standard	OP-090608-2PW	75014-IP20-1	8IP-20	121.0 in-lbs (1370 N-cm)
AM300®	9/16	14.29	C5 (P35)	High Rake	OP-090608-PWHR	75014-IP20-1	8IP-20	121.0 in-lbs (1370 N-cm)

*Tightening torques are calculated with a friction coefficient of $\mu = 0.14$ and develop 90% of ultimate yield strength

Pilot Accessories

Pilot Style	Series	 Insert Screws	 Insert Driver	Admissible Tightening Torque*
T-A	2	7495-IP15-1	8IP-15	61.0 in-lbs (690 N-cm)
GEN3SYS	26	7495-IP15-1	8IP-15	61.0 in-lbs (690 N-cm)
GEN3SYS	29	7495-IP15-1	8IP-15	61.0 in-lbs (690 N-cm)
GEN3SYS	32	7495-IP15-1	8IP-15	61.0 in-lbs (690 N-cm)

*Tightening torques are calculated with a friction coefficient of $\mu = 0.14$ and develop 90% of ultimate yield strength

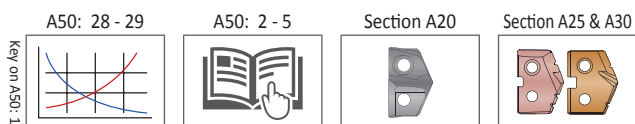

Nonstocked diameters are also available. Follow the examples shown below.

Inch	38 series, T-A (1 series), 1.6790"	Part No. = V3801D-1.6790
Metric	38 series, T-A (1 series), 42.15 mm	Part No. = V3801D-42.15

IC inserts sold in multiples of 2 | Insert screws sold in multiples of 10



APX Drill Holders

63 Series | Diameter Range: 2.480" - 2.756" (63.00 mm - 69.99 mm)

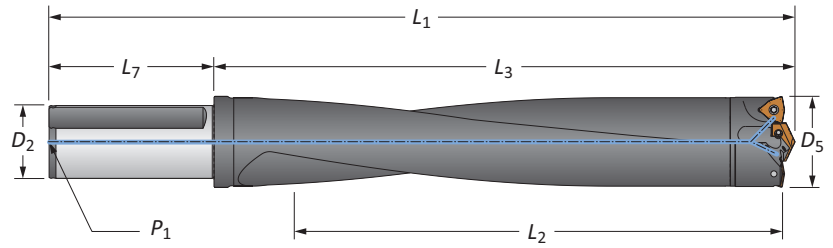

Straight Shank

	Length	Body				Shank			Part No.
		D ₅	L ₂	L ₃	L ₁	L ₇	D ₂	P ₁	
i	3xD	2.480 - 2.756	7-7/8	10-11/32	14-27/32	4-1/2	2	1/4 NPT	W6303H-200F
	5xD	2.480 - 2.756	13-3/4	15-27/32	20-11/32	4-1/2	2	1/4 NPT	W6305H-200F
	8xD	2.480 - 2.756	22-1/8	24-1/8	28-5/8	4-1/2	2	1/4 NPT	⚠ W6308H-200F
	10xD	2.480 - 2.756	27-1/8	29-11/64	33-43/64	4-1/2	2	1/4 NPT	⚠ W6310H-200F
m	3xD	63.00 - 69.99	200.81	262.61	342.60	80.00	50.00	1/4 BSPT	W6303H-50FM
	5xD	63.00 - 69.99	350.00	402.59	482.60	80.00	50.00	1/4 BSPT	W6305H-50FM
	8xD	63.00 - 69.99	559.99	612.60	692.61	80.00	50.00	1/4 BSPT	⚠ W6308H-50FM
	10xD	63.00 - 69.99	688.29	740.89	820.90	80.00	50.00	1/4 BSPT	⚠ W6310H-50FM

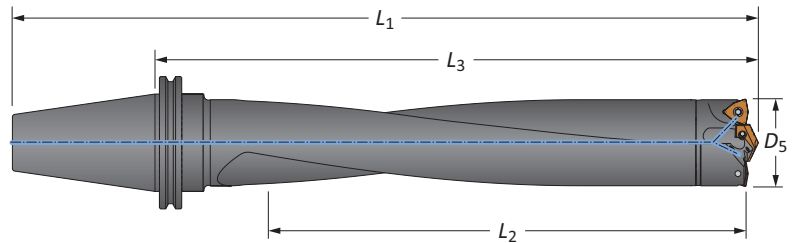

CV50 Shank

	Length	D ₅		Body			Shank	Part No.
		inch	mm	L ₂	L ₃	L ₁		
i	3xD	2.480 - 2.756	63.00 - 69.99	7-7/8	11-7/16	15-7/16	CV50	W6303H-CV50
	5xD	2.480 - 2.756	63.00 - 69.99	13-3/4	16-15/16	20-15/16	CV50	W6305H-CV50
	8xD	2.480 - 2.756	63.00 - 69.99	22	25-13/64	29-13/64	CV50	⚠ W6308H-CV50
	10xD	2.480 - 2.756	63.00 - 69.99	26-1/2	29-43/64	33-43/64	CV50	⚠ W6310H-CV50

Connection Accessories

Mounting Screw	Mounting Screw Driver	Admissible Tightening Torque*
75020-IP20-1	8IP-20	60 in-lb (678 N-cm)

*Tightening torques are calculated with a friction coefficient of $\mu = 0.14$ and develop 90% of ultimate yield strength

⚠ WARNING Refer to Speed and Feed charts for recommended adjustments to speeds and feeds. Refer to page A50: 30 for deep hole drilling guidelines in this section of the catalog. Visit www.alliedmachine.com/DeepHoleGuidelines for the most up-to-date information and procedures. Factory technical assistance is available for your specific applications through our Application Engineering Team.
ext: 7611 | email: appeng@alliedmachine.com

i = Imperial (in)
m = Metric (mm)

Mounting screws sold in multiples of 4



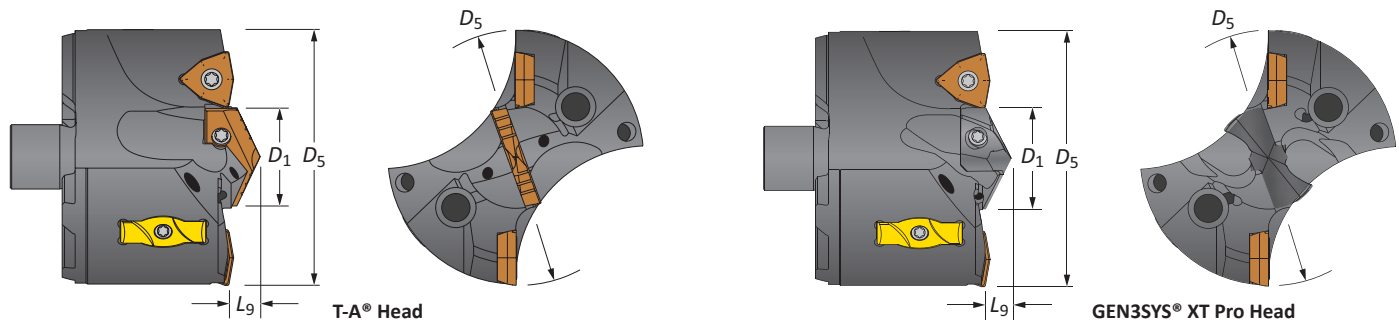

APX Drill Heads

70 Series | Diameter Range: 2.756" - 2.992" (70.00 mm - 75.99 mm)





Heads

Head					T-A Head				GEN3SYS XT Pro Head				
D_5 fractional	D_5 inch	D_5 metric	D_1	L_9	Part No.	Pilot Series	 T-A Pro Insert	 T-A (-TC) Insert	Part No.	Pilot Series	 Pilot Insert	IC Insert Size	
												inch	metric
-	2.756	70.00	1-7/32	25/64	V7002S-70	2	TA#2-30.96	1C12H-0107-TC	V7029S-70	29	XT#29-30.96	3/8	9.53
2-13/16	2.813	71.44	1-7/32	25/64	V7002S-0226	2	TA#2-30.96	1C12H-0107-TC	V7029S-0226	29	XT#29-30.96	3/8	9.53
-	2.835	72.00	1-7/32	25/64	V7002S-72	2	TA#2-30.96	1C12H-0107-TC	V7029S-72	29	XT#29-30.96	3/8	9.53
2-7/8	2.875	73.03	1-7/32	25/64	V7002S-0228	2	TA#2-30.96	1C12H-0107-TC	V7029S-0228	29	XT#29-30.96	3/8	9.53
-	2.913	74.00	1-7/32	25/64	V7002S-74	2	TA#2-30.96	1C12H-0107-TC	V7029S-74	29	XT#29-30.96	3/8	9.53
2-15/16	2.938	74.61	1-7/32	25/64	V7002S-0230	2	TA#2-30.96	1C12H-0107-TC	V7029S-0230	29	XT#29-30.96	3/8	9.53



#Denotes ISO material/geometry (P= steel, K= cast iron, N= nonferrous)

IC Inserts

Coating	Size		Grade	Geometry	 Part No.	 Insert Screw	 Insert Driver	Admissible Tightening Torque*
	inch	metric						
AM300®	3/8	9.53	C5 (P35)	Standard	OP-060408-PW	73595-IP15-1	8IP-15	41.0 in-lbs (465 N-cm)
AM300®	3/8	9.53	C1 (K35)	Standard	OP-060408-1PW	73595-IP15-1	8IP-15	41.0 in-lbs (465 N-cm)
AM300®	3/8	9.53	C2 (K25)	Standard	OP-060408-2PW	73595-IP15-1	8IP-15	41.0 in-lbs (465 N-cm)
AM300®	3/8	9.53	C5 (P35)	High Rake	OP-060408-PWHR	73595-IP15-1	8IP-15	41.0 in-lbs (465 N-cm)



*Tightening torques are calculated with a friction coefficient of $\mu = 0.14$ and develop 90% of ultimate yield strength

Wear Pads

 Part No.	 Wear Pad Screw	 Wear Pad Driver	Admissible Tightening Torque*
WP7095	7358-IP10-1	8IP-10	27.0 in-lbs (300 N-cm)

*Tightening torques are calculated with a friction coefficient of $\mu = 0.14$ and develop 90% of ultimate yield strength

Pilot Accessories

Pilot Style	Series	 Insert Screws	 Insert Driver	Admissible Tightening Torque*
T-A	2	7495-IP15-1	8IP-15	61.0 in-lbs (690 N-cm)
GEN3SYS	29	7495-IP15-1	8IP-15	61.0 in-lbs (690 N-cm)

*Tightening torques are calculated with a friction coefficient of $\mu = 0.14$ and develop 90% of ultimate yield strength

Nonstocked diameters are also available. Follow the examples shown below.

Inch	38 series, T-A (1 series), 1.6790"	Part No. = V3801D-1.6790
Metric	38 series, T-A (1 series), 42.15 mm	Part No. = V3801D-42.15

Wear pads sold in multiples of 2 | Wear pad screws sold in multiples of 4
IC inserts sold in multiples of 2 | Insert screws sold in multiples of 10



APX Drill Holders

70 Series | Diameter Range: 2.756" - 2.992" (70.00 mm - 75.99 mm)

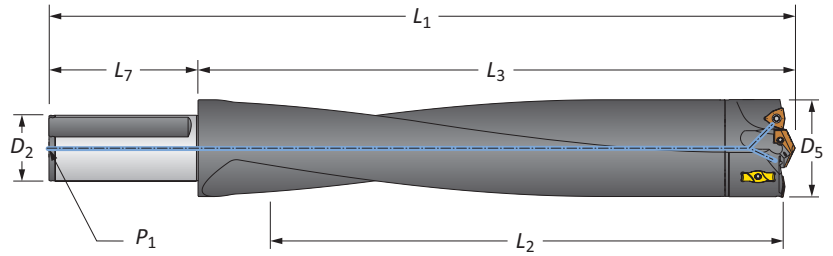

Straight Shank

	Length	Body				Shank			Part No.
		D ₅	L ₂	L ₃	L ₁	L ₇	D ₂	P ₁	
i	3xD	2.756 - 2.992	8-3/4	10-19/32	15-3/32	4-1/2	2	1/4 NPT	W7003H-200F
	5xD	2.756 - 2.992	14-7/8	16-37/64	21-5/64	4-1/2	2	1/4 NPT	W7005H-200F
	8xD	2.756 - 2.992	23-7/8	25-35/64	30-3/64	4-1/2	2	1/4 NPT	W7008H-200F
	10xD	2.756 - 2.992	27-7/8	29-35/64	34-3/64	4-1/2	2	1/4 NPT	W7010H-200F
m	3xD	70.00 - 75.99	218.80	269.01	349.00	80.00	50.00	1/4 BSPT	W7003H-50FM
	5xD	70.00 - 75.99	380.01	421.11	501.09	80.00	50.00	1/4 BSPT	W7005H-50FM
	8xD	70.00 - 75.99	608.00	649.00	729.01	80.00	50.00	1/4 BSPT	W7008H-50FM
	10xD	70.00 - 75.99	709.40	750.29	830.30	80.00	50.00	1/4 BSPT	W7010H-50FM

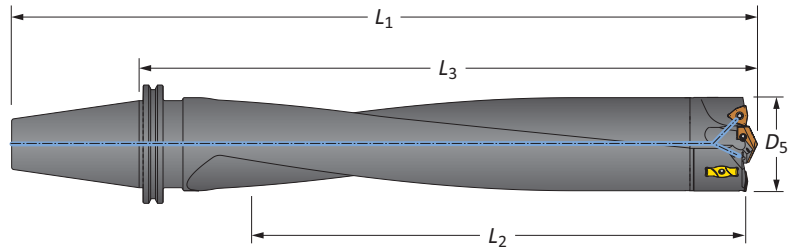

CV50 Shank

	Length	D ₅		Body			Shank	Part No.
		inch	mm	L ₂	L ₃	L ₁		
i	3xD	2.756 - 2.992	70.00 - 75.99	8-3/4	12-7/32	16-7/32	CV50	W7003H-CV50
	5xD	2.756 - 2.992	70.00 - 75.99	14-7/8	18-13/64	22-13/64	CV50	W7005H-CV50
	8xD	2.756 - 2.992	70.00 - 75.99	23-7/8	27-5/32	31-5/32	CV50	W7008H-CV50
	10xD	2.756 - 2.992	70.00 - 75.99	26-3/4	29-61/64	33-61/64	CV50	W7010H-CV50

Connection Accessories

Mounting Screw	Mounting Screw Bit	Admissible Tightening Torque*
78027-IP30-1	8IP-30B	250 in-lb (2825 N-cm)

*Tightening torques are calculated with a friction coefficient of $\mu = 0.14$ and develop 90% of ultimate yield strength

⚠ WARNING Refer to Speed and Feed charts for recommended adjustments to speeds and feeds. Refer to page A50: 30 for deep hole drilling guidelines in this section of the catalog. Visit www.alliedmachine.com/DeepHoleGuidelines for the most up-to-date information and procedures. Factory technical assistance is available for your specific applications through our Application Engineering Team.
ext: 7611 | email: appeng@alliedmachine.com

i = Imperial (in)
m = Metric (mm)



Mounting screws sold in multiples of 4

APX Drill Heads

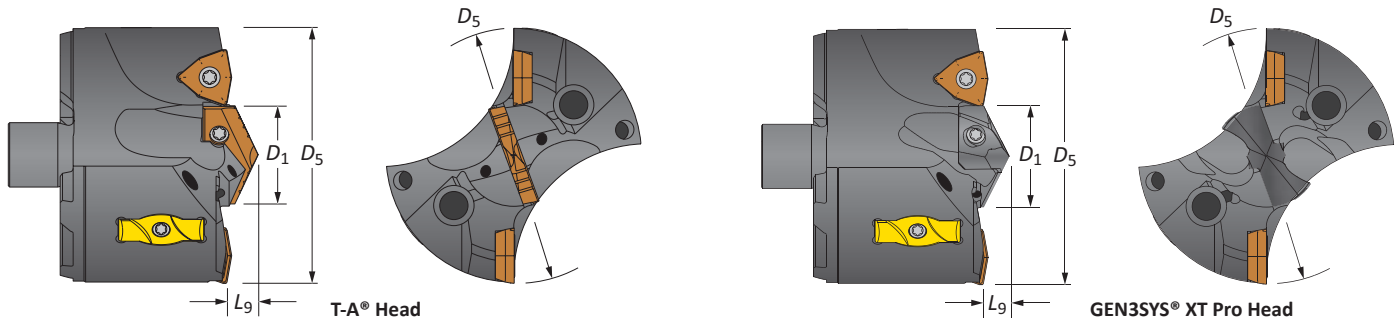
76 Series | Diameter Range: 2.992" - 3.268" (76.00 mm - 82.99 mm)





Heads

Head					T-A Head				GEN3SYS XT Pro Head			IC Insert Size	
D_5 fractional	D_5 inch	D_5 metric	D_1	L_9	Part No.	Pilot Series			Part No.	Pilot Series		inch	metric
-	2.992	76.00	1-7/32	13/32	V7602S-76	2	TA#2-30.96	1C12H-0107-TC	V7629S-76	29	XT#29-30.96	1/2	12.70
3	3.000	76.20	1-7/32	13/32	V7602S-0300	2	TA#2-30.96	1C12H-0107-TC	V7629S-0300	29	XT#29-30.96	1/2	12.70
3-1/16	3.063	77.79	1-7/32	13/32	V7602S-0302	2	TA#2-30.96	1C12H-0107-TC	V7629S-0302	29	XT#29-30.96	1/2	12.70
-	3.071	78.00	1-7/32	13/32	V7602S-78	2	TA#2-30.96	1C12H-0107-TC	V7629S-78	29	XT#29-30.96	1/2	12.70
3-1/8	3.125	79.38	1-7/32	13/32	V7602S-0304	2	TA#2-30.96	1C12H-0107-TC	V7629S-0304	29	XT#29-30.96	1/2	12.70
-	3.150	80.00	1-7/32	13/32	V7602S-80	2	TA#2-30.96	1C12H-0107-TC	V7629S-80	29	XT#29-30.96	1/2	12.70
3-3/16	3.188	80.96	1-7/32	13/32	V7602S-0306	2	TA#2-30.96	1C12H-0107-TC	V7629S-0306	29	XT#29-30.96	1/2	12.70
-	3.228	82.00	1-7/32	13/32	V7602S-82	2	TA#2-30.96	1C12H-0107-TC	V7629S-82	29	XT#29-30.96	1/2	12.70
3-1/4	3.250	82.55	1-7/32	13/32	V7602S-0308	2	TA#2-30.96	1C12H-0107-TC	V7629S-0308	29	XT#29-30.96	1/2	12.70

#Denotes ISO material/geometry (P= steel, K= cast iron, N= nonferrous)

IC Inserts

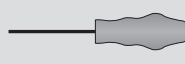
Coating	Size		Grade	Geometry				Admissible Tightening Torque*
	inch	metric						
AM300®	1/2	12.70	C5 (P35)	Standard	OP-080508-PW	74012-IP15-1	8IP-15	61.0 in-lbs (690 N-cm)
AM300®	1/2	12.70	C1 (K35)	Standard	OP-080508-1PW	74012-IP15-1	8IP-15	61.0 in-lbs (690 N-cm)
AM300®	1/2	12.70	C2 (K25)	Standard	OP-080508-2PW	74012-IP15-1	8IP-15	61.0 in-lbs (690 N-cm)
AM300®	1/2	12.70	C5 (P35)	High Rake	OP-080508-PWHR	74012-IP15-1	8IP-15	61.0 in-lbs (690 N-cm)



*Tightening torques are calculated with a friction coefficient of $\mu = 0.14$ and develop 90% of ultimate yield strength

Wear Pads

			Admissible Tightening Torque*
Part No.	Wear Pad Screw	Wear Pad Driver	
WP7095	7358-IP10-1	8IP-10	27.0 in-lbs (300 N-cm)

*Tightening torques are calculated with a friction coefficient of $\mu = 0.14$ and develop 90% of ultimate yield strength

Pilot Accessories

Pilot Style	Series			Admissible Tightening Torque*
T-A	2	7495-IP15-1	8IP-15	61.0 in-lbs (690 N-cm)
GEN3SYS	29	7495-IP15-1	8IP-15	61.0 in-lbs (690 N-cm)

*Tightening torques are calculated with a friction coefficient of $\mu = 0.14$ and develop 90% of ultimate yield strength

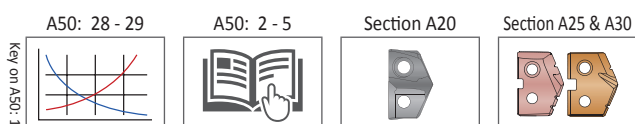

Non-tocked diameters are also available. Follow the examples shown below.

Inch	38 series, T-A (1 series), 1.6790"	Part No. = V3801D-1.6790
Metric	38 series, T-A (1 series), 42.15 mm	Part No. = V3801D-42.15

Wear pads sold in multiples of 2 | Wear pad screws sold in multiples of 4
IC inserts sold in multiples of 2 | Insert screws sold in multiples of 10

APX Drill Holders

76 Series | Diameter Range: 2.992" - 3.268" (76.00 mm - 82.99 mm)

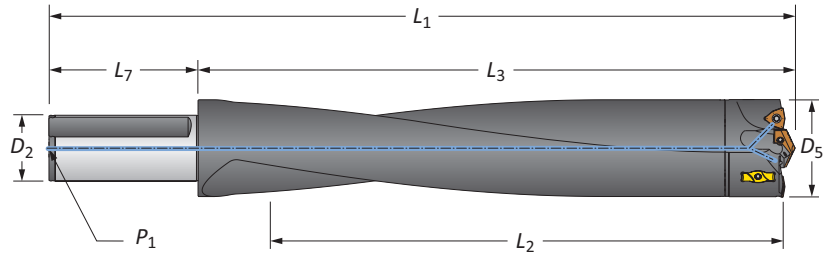

Straight Shank

	Length	D ₅		Body			Shank		Part No.	
		inch	mm	L ₂	L ₃	L ₁	L ₇	D ₂		P ₁
i	3xD	2.992 - 3.268	76.00 - 82.99	9-1/2	11-33/64	16-1/64	4-1/2	2	1/4 NPT	W7603H-200F
	5xD	2.992 - 3.268	76.00 - 82.99	16-3/8	18-3/64	22-35/64	4-1/2	2	1/4 NPT	W7605H-200F
	8xD	2.992 - 3.268	76.00 - 82.99	26-1/8	27-27/32	32-11/32	4-1/2	2	1/4 NPT	W7608H-200F
m	3xD	2.992 - 3.268	76.00 - 82.99	240.00	292.40	372.39	80.00	50.00	1/4 BSPT	W7603H-50FM
	5xD	2.992 - 3.268	76.00 - 82.99	415.01	421.11	501.09	80.00	50.00	1/4 BSPT	W7605H-50FM
	8xD	2.992 - 3.268	76.00 - 82.99	664.01	648.69	728.70	80.00	50.00	1/4 BSPT	W7608H-50FM

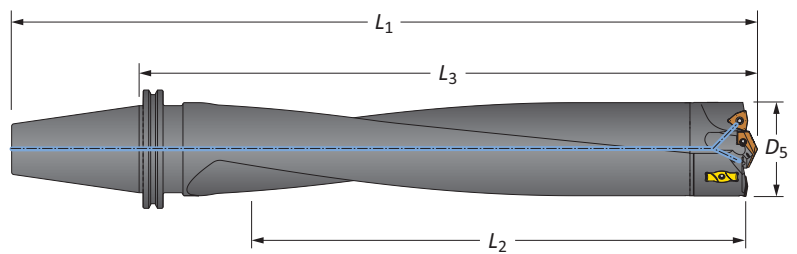

CV50 Shank

	Length	D ₅		Body			Shank	Part No.
		inch	mm	L ₂	L ₃	L ₁		
i	3xD	2.992 - 3.268	76.00 - 82.99	9-1/2	12-57/64	16-57/64	CV50	W7603H-CV50
	5xD	2.992 - 3.268	76.00 - 82.99	16-3/8	19-27/64	23-27/64	CV50	W7605H-CV50
	8xD	2.992 - 3.268	76.00 - 82.99	26-1/8	29-7/32	33-7/32	CV50	W7608H-CV50

Connection Accessories

Mounting Screw	Mounting Screw Bit	Admissible Tightening Torque*
78027-IP30-1	8IP-30B	250 in-lb (2825 N-cm)

*Tightening torques are calculated with a friction coefficient of $\mu = 0.14$ and develop 90% of ultimate yield strength

⚠ WARNING Refer to Speed and Feed charts for recommended adjustments to speeds and feeds. Refer to page A50: 30 for deep hole drilling guidelines in this section of the catalog. Visit www.alliedmachine.com/DeepHoleGuidelines for the most up-to-date information and procedures. Factory technical assistance is available for your specific applications through our Application Engineering Team.
ext: 7611 | email: appeng@alliedmachine.com

i = Imperial (in)
m = Metric (mm)

Mounting screws sold in multiples of 4

APX Drill Heads

83 Series | Diameter Range: 3.268" - 3.504" (83.00 mm - 88.99 mm)

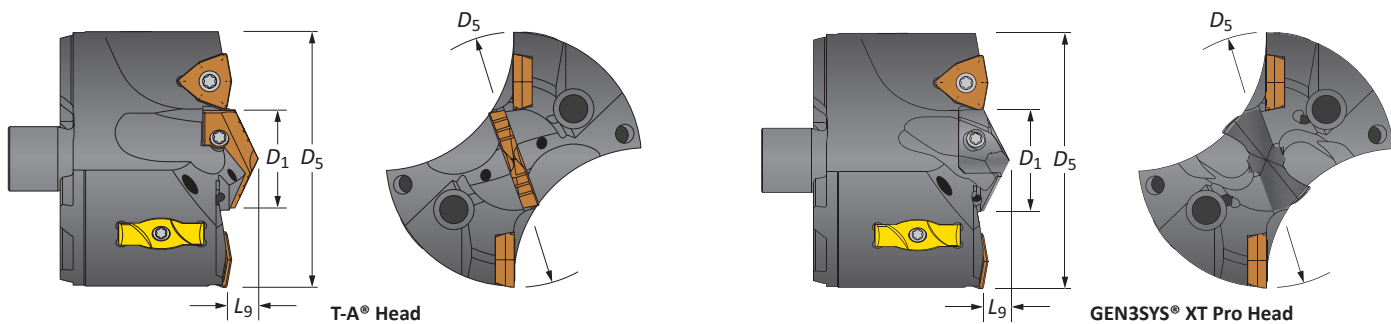

Heads

Head					T-A Head				GEN3SYS XT Pro Head			IC Insert Size	
D ₅ fractional	D ₅ inch	D ₅ metric	D ₁	L ₉	Part No.	Pilot Series	T-A Pro Insert	T-A (-TC) Insert	Part No.	Pilot Series	Pilot Insert	inch	metric
-	3.307	84.00	1-3/8	7/16	V8302S-84	2	TA#2-34.93	1C12H-0112-TC	V8332S-84	32	XT#32-34.93	1/2	12.70
3-5/16	3.313	84.14	1-3/8	7/16	V8302S-0310	2	TA#2-34.93	1C12H-0112-TC	V8332S-0310	32	XT#32-34.93	1/2	12.70
3-3/8	3.375	85.73	1-3/8	7/16	V8302S-0312	2	TA#2-34.93	1C12H-0112-TC	V8332S-0312	32	XT#32-34.93	1/2	12.70
-	3.386	86.00	1-3/8	7/16	V8302S-86	2	TA#2-34.93	1C12H-0112-TC	V8332S-86	32	XT#32-34.93	1/2	12.70
3-7/16	3.438	87.31	1-3/8	7/16	V8302S-0314	2	TA#2-34.93	1C12H-0112-TC	V8332S-0314	32	XT#32-34.93	1/2	12.70
-	3.465	88.00	1-3/8	7/16	V8302S-88	2	TA#2-34.93	1C12H-0112-TC	V8332S-88	32	XT#32-34.93	1/2	12.70
3-1/2	3.500	88.90	1-3/8	7/16	V8302S-0316	2	TA#2-34.93	1C12H-0112-TC	V8332S-0316	32	XT#32-34.93	1/2	12.70

#Denotes ISO material/geometry (P= steel, K= cast iron, N= nonferrous)

IC Inserts

Coating	Size		Grade	Geometry	Part No.	Insert Screw	Insert Driver	Admissible Tightening Torque*
	inch	metric						
AM300®	1/2	12.70	C5 (P35)	Standard	OP-080508-PW	74012-IP15-1	8IP-15	61.0 in-lbs (690 N-cm)
AM300®	1/2	12.70	C1 (K35)	Standard	OP-080508-1PW	74012-IP15-1	8IP-15	61.0 in-lbs (690 N-cm)
AM300®	1/2	12.70	C2 (K25)	Standard	OP-080508-2PW	74012-IP15-1	8IP-15	61.0 in-lbs (690 N-cm)
AM300®	1/2	12.70	C5 (P35)	High Rake	OP-080508-PWHR	74012-IP15-1	8IP-15	61.0 in-lbs (690 N-cm)

*Tightening torques are calculated with a friction coefficient of $\mu = 0.14$ and develop 90% of ultimate yield strength

Wear Pads

Part No.	Wear Pad Screw	Wear Pad Driver	Admissible Tightening Torque*
WP7095	7358-IP10-1	8IP-10	27.0 in-lbs (300 N-cm)

*Tightening torques are calculated with a friction coefficient of $\mu = 0.14$ and develop 90% of ultimate yield strength

Pilot Accessories

Pilot Style	Series	Insert Screws	Insert Driver	Admissible Tightening Torque*
T-A	2	7495-IP15-1	8IP-15	61.0 in-lbs (690 N-cm)
GEN3SYS	32	7495-IP15-1	8IP-15	61.0 in-lbs (690 N-cm)

*Tightening torques are calculated with a friction coefficient of $\mu = 0.14$ and develop 90% of ultimate yield strength

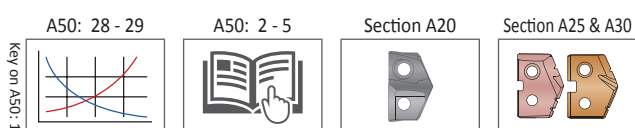

Nonstocked diameters are also available. Follow the examples shown below.

Inch	38 series, T-A (1 series), 1.6790"	Part No. = V3801D-1.6790
Metric	38 series, T-A (1 series), 42.15 mm	Part No. = V3801D-42.15

Wear pads sold in multiples of 2 | Wear pad screws sold in multiples of 4
IC inserts sold in multiples of 2 | Insert screws sold in multiples of 10

A DRILLING
B BORING
C REAMING
D BURNISHING
E THREADING
X SPECIALS

APX Drill Holders

83 Series | Diameter Range: 3.268" - 3.504" (83.00 mm - 88.99 mm)

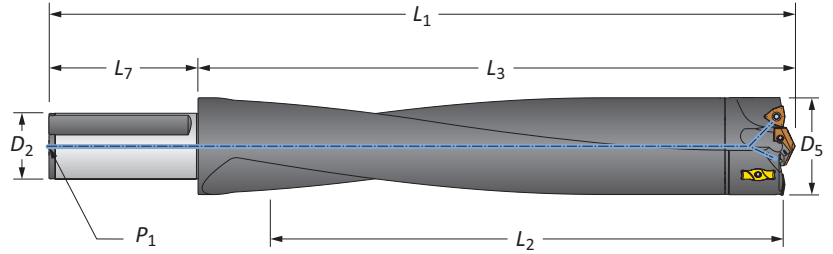

Straight Shank

	Length	D ₅		Body			Shank		Part No.	
		inch	mm	L ₂	L ₃	L ₁	L ₇	D ₂		P ₁
i	3xD	3.268 - 3.504	83.00 - 88.99	10-1/8	12-5/16	16-13/16	4-1/2	2	1/4 NPT	W8303H-200F
	5xD	3.268 - 3.504	83.00 - 88.99	17-1/2	19-5/16	23-13/16	4-1/2	2	1/4 NPT	W8305H-200F
	8xD	3.268 - 3.504	83.00 - 88.99	27-3/4	29-35/64	34-3/64	4-1/2	2	1/4 NPT	W8308H-200F
m	3xD	3.268 - 3.504	83.00 - 88.99	257.81	312.50	392.61	80.00	50.00	1/4 BSPT	W8303H-50FM
	5xD	3.268 - 3.504	83.00 - 88.99	445.00	490.50	570.51	80.00	50.00	1/4 BSPT	W8305H-50FM
	8xD	3.268 - 3.504	83.00 - 88.99	704.90	750.29	830.30	80.00	50.00	1/4 BSPT	W8308H-50FM

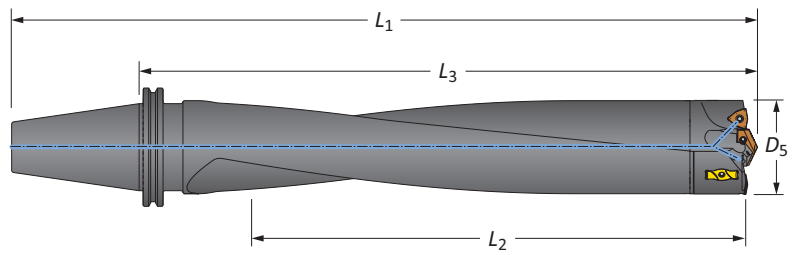

CV50 Shank

	Length	D ₅		Body			Shank	Part No.
		inch	mm	L ₂	L ₃	L ₁		
i	3xD	3.268 - 3.504	83.00 - 88.99	10-1/8	13-11/16	17-11/16	CV50	W8303H-CV50
	5xD	3.268 - 3.504	83.00 - 88.99	17-1/2	20-11/16	24-11/16	CV50	W8305H-CV50
	8xD	3.268 - 3.504	83.00 - 88.99	26-7/8	30-3/64	34-3/64	CV50	W8308H-CV50

Connection Accessories

Mounting Screw	Mounting Screw Bit	Admissible Tightening Torque*
78027-IP30-1	8IP-30B	250 in-lb (2825 N-cm)

*Tightening torques are calculated with a friction coefficient of $\mu = 0.14$ and develop 90% of ultimate yield strength

⚠ WARNING Refer to Speed and Feed charts for recommended adjustments to speeds and feeds. Refer to page A50: 30 for deep hole drilling guidelines in this section of the catalog. Visit www.alliedmachine.com/DeepHoleGuidelines for the most up-to-date information and procedures. Factory technical assistance is available for your specific applications through our Application Engineering Team.
ext: 7611 | email: appeng@alliedmachine.com

i = Imperial (in)
m = Metric (mm)



Mounting screws sold in multiples of 4

APX Drill Heads

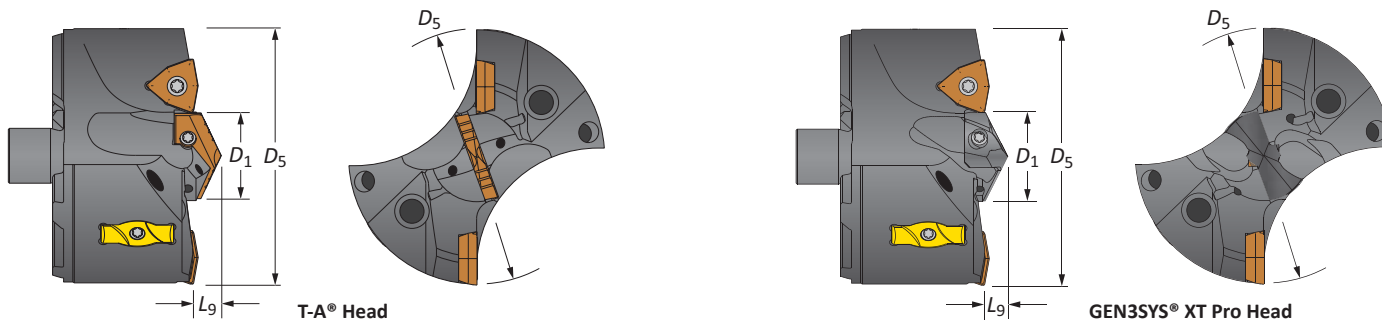
89 Series | Diameter Range: 3.504" - 3.740" (89.00 mm - 94.99 mm)





Heads

Head					T-A Head				GEN3SYS XT Pro Head			IC Insert Size	
D_5 fractional	D_5 inch	D_5 metric	D_1	L_9	Part No.	Pilot Series			Part No.	Pilot Series		inch	metric
-	3.543	90.00	1-1/4	27/64	V8902S-90	2	TA#2-31.75	1C12H-0108-TC	V8929S-90	29	XT#29-31.75	9/16	14.29
3-9/16	3.563	90.49	1-1/4	27/64	V8902S-0318	2	TA#2-31.75	1C12H-0108-TC	V8929S-0318	29	XT#29-31.75	9/16	14.29
-	3.622	92.00	1-1/4	27/64	V8902S-92	2	TA#2-31.75	1C12H-0108-TC	V8929S-92	29	XT#29-31.75	9/16	14.29
3-5/8	3.625	92.08	1-1/4	27/64	V8902S-0320	2	TA#2-31.75	1C12H-0108-TC	V8929S-0320	29	XT#29-31.75	9/16	14.29
3-11/16	3.688	93.66	1-1/4	27/64	V8902S-0322	2	TA#2-31.75	1C12H-0108-TC	V8929S-0322	29	XT#29-31.75	9/16	14.29
-	3.701	94.00	1-1/4	27/64	V8902S-94	2	TA#2-31.75	1C12H-0108-TC	V8929S-94	29	XT#29-31.75	9/16	14.29



#Denotes ISO material/geometry (P= steel, K= cast iron, N= nonferrous)

IC Inserts

Coating	Size		Grade	Geometry	 Part No.	 Insert Screw	 Insert Driver	Admissible Tightening Torque*
	inch	metric						
AM300®	9/16	14.29	C5 (P35)	Standard	OP-090608-PW	75014-IP20-1	8IP-20	121.0 in-lbs (1370 N-cm)
AM300®	9/16	14.29	C1 (K35)	Standard	OP-090608-1PW	75014-IP20-1	8IP-20	121.0 in-lbs (1370 N-cm)
AM300®	9/16	14.29	C2 (K25)	Standard	OP-090608-2PW	75014-IP20-1	8IP-20	121.0 in-lbs (1370 N-cm)
AM300®	9/16	14.29	C5 (P35)	High Rake	OP-090608-PWHR	75014-IP20-1	8IP-20	121.0 in-lbs (1370 N-cm)

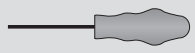

*Tightening torques are calculated with a friction coefficient of $\mu = 0.14$ and develop 90% of ultimate yield strength

Wear Pads

 Part No.	 Wear Pad Screw	 Wear Pad Driver	Admissible Tightening Torque*
WP7095	7358-IP10-1	8IP-10	27.0 in-lbs (300 N-cm)

*Tightening torques are calculated with a friction coefficient of $\mu = 0.14$ and develop 90% of ultimate yield strength

Pilot Accessories

Pilot Style	Series	 Insert Screws	 Insert Driver	Admissible Tightening Torque*
T-A	2	7495-IP15-1	8IP-15	61.0 in-lbs (690 N-cm)
GEN3SYS	29	7495-IP15-1	8IP-15	61.0 in-lbs (690 N-cm)

*Tightening torques are calculated with a friction coefficient of $\mu = 0.14$ and develop 90% of ultimate yield strength

A50: 28 - 29

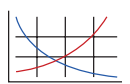

A50: 2 - 5



Section A20



Section A25 & A30

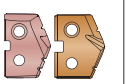

Nonstocked diameters are also available. Follow the examples shown below.

Inch	38 series, T-A (1 series), 1.6790"	Part No. = V3801D-1.6790
Metric	38 series, T-A (1 series), 42.15 mm	Part No. = V3801D-42.15

Wear pads sold in multiples of 2 | Wear pad screws sold in multiples of 4
IC inserts sold in multiples of 2 | Insert screws sold in multiples of 10

A DRILLING
B BORING
C REAMING
D BURNISHING
E THREADING
X SPECIALS

APX Drill Holders

89 Series | Diameter Range: 3.504" - 3.740" (89.00 mm - 94.99 mm)

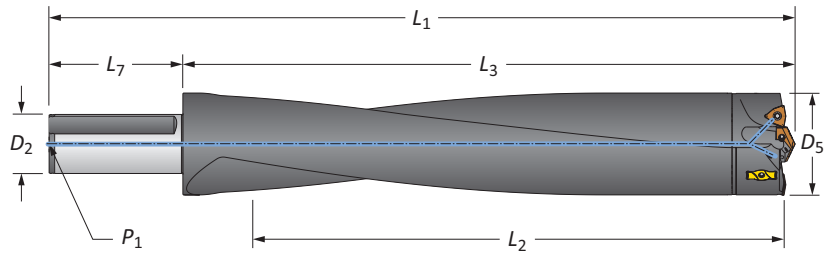

Straight Shank

	Length	D ₅		Body			Shank		Part No.	
		inch	mm	L ₂	L ₃	L ₁	L ₇	D ₂		P ₁
i	3xD	3.504 - 3.740		10-7/8	13-1/8	17-5/8	4-1/2	2	1/4 NPT	W8903H-200F
	5xD	3.504 - 3.740		18-5/8	20-5/8	25-1/8	4-1/2	2	1/4 NPT	W8905H-200F
	8xD	3.504 - 3.740		27-5/8	29-35/64	34-3/64	4-1/2	2	1/4 NPT	W8908H-200F
m	3xD	89.00 - 94.99		275.79	333.60	413.59	80.00	50.00	1/4 BSPT	W8903H-50FM
	5xD	89.00 - 94.99		475.01	523.70	603.71	80.00	50.00	1/4 BSPT	W8905H-50FM
	8xD	89.00 - 94.99		701.80	750.29	830.30	80.00	50.00	1/4 BSPT	W8908H-50FM

*Thread to BSP and ISO 7-1

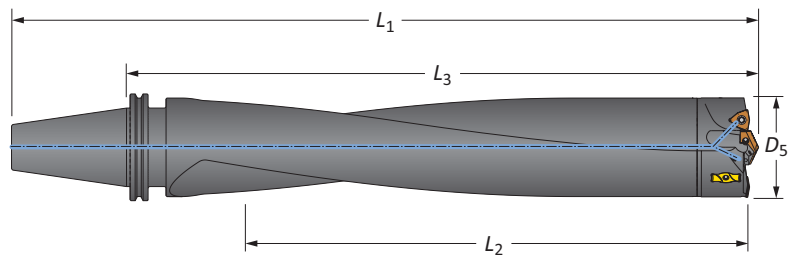

CV50 Shank

	Length	D ₅		Body			Shank	Part No.	
		inch	mm	L ₂	L ₃	L ₁			
i	3xD	3.504 - 3.740		89.00 - 94.99	10-7/8	14-33/64	18-33/64	CV50	W8903H-CV50
	5xD	3.504 - 3.740		89.00 - 94.99	18-5/8	22	26	CV50	W8905H-CV50
	8xD	3.504 - 3.740		89.00 - 94.99	26-3/4	30-1/32	34-1/32	CV50	W8908H-CV50

Connection Accessories

Mounting Screw	Mounting Screw Bit	Admissible Tightening Torque*
78027-IP30-1	8IP-30B	250 in-lb (2825 N-cm)

*Tightening torques are calculated with a friction coefficient of $\mu = 0.14$ and develop 90% of ultimate yield strength

⚠ WARNING Refer to Speed and Feed charts for recommended adjustments to speeds and feeds. Refer to page A50: 30 for deep hole drilling guidelines in this section of the catalog. Visit www.alliedmachine.com/DeepHoleGuidelines for the most up-to-date information and procedures. Factory technical assistance is available for your specific applications through our Application Engineering Team.
ext: 7611 | email: appeng@alliedmachine.com

i = Imperial (in)
m = Metric (mm)

Mounting screws sold in multiples of 4

APX Drill Heads

95 Series | Diameter Range: 3.740" - 4.000" (95.00 mm - 101.60 mm)

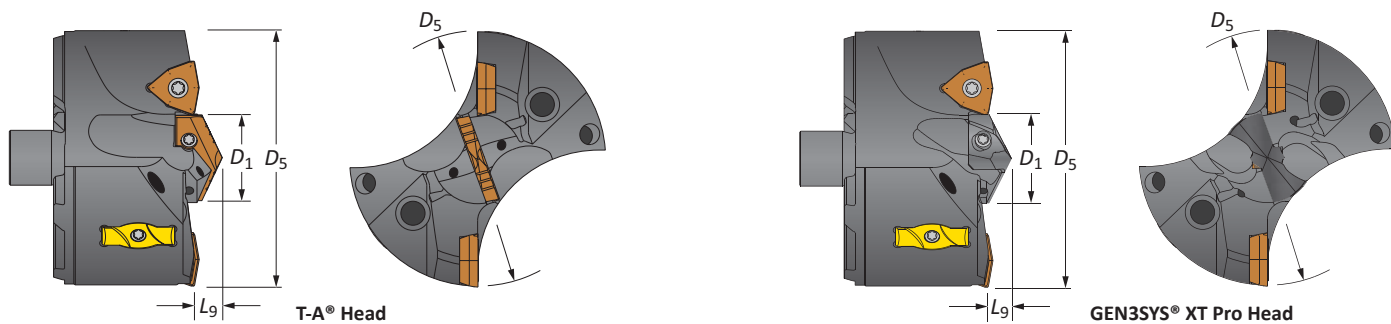

Heads

Head					T-A Head				GEN3SYS XT Pro Head			IC Insert Size	
D ₅ fractional	D ₅ inch	D ₅ metric	D ₁	L ₉	Part No.	Pilot Series	T-A Pro Insert	T-A (-TC) Insert	Part No.	Pilot Series	Pilot Insert	inch	metric
3-3/4	3.750	95.25	1-3/8	29/64	V9502S-0324	2	TA#2-34.93	1C12H-0112-TC	V9532S-0324	32	XT#32-34.93	9/16	14.29
-	3.780	96.00	1-3/8	29/64	V9502S-96	2	TA#2-34.93	1C12H-0112-TC	V9532S-96	32	XT#32-34.93	9/16	14.29
3-13/16	3.813	96.84	1-3/8	29/64	V9502S-0326	2	TA#2-34.93	1C12H-0112-TC	V9532S-0326	32	XT#32-34.93	9/16	14.29
-	3.858	98.00	1-3/8	29/64	V9502S-98	2	TA#2-34.93	1C12H-0112-TC	V9532S-98	32	XT#32-34.93	9/16	14.29
3-7/8	3.875	98.43	1-3/8	29/64	V9502S-0328	2	TA#2-34.93	1C12H-0112-TC	V9532S-0328	32	XT#32-34.93	9/16	14.29
-	3.937	100.00	1-3/8	29/64	V9502S-100	2	TA#2-34.93	1C12H-0112-TC	V9532S-100	32	XT#32-34.93	9/16	14.29
3-15/16	3.936	100.01	1-3/8	29/64	V9502S-0330	2	TA#2-34.93	1C12H-0112-TC	V9532S-0330	32	XT#32-34.93	9/16	14.29
4	4.000	101.60	1-3/8	29/64	V9502S-0400	2	TA#2-34.93	1C12H-0112-TC	V9532S-0400	32	XT#32-34.93	9/16	14.29

#Denotes ISO material/geometry (P= steel, K= cast iron, N= nonferrous)

IC Inserts

Coating	Size		Grade	Geometry	Part No.	Insert Screw	Insert Driver	Admissible Tightening Torque*
	inch	metric						
AM300®	9/16	14.29	C5 (P35)	Standard	OP-090608-PW	75014-IP20-1	8IP-20	121.0 in-lbs (1370 N-cm)
AM300®	9/16	14.29	C1 (K35)	Standard	OP-090608-1PW	75014-IP20-1	8IP-20	121.0 in-lbs (1370 N-cm)
AM300®	9/16	14.29	C2 (K25)	Standard	OP-090608-2PW	75014-IP20-1	8IP-20	121.0 in-lbs (1370 N-cm)
AM300®	9/16	14.29	C5 (P35)	High Rake	OP-090608-PWHR	75014-IP20-1	8IP-20	121.0 in-lbs (1370 N-cm)

*Tightening torques are calculated with a friction coefficient of $\mu = 0.14$ and develop 90% of ultimate yield strength

Wear Pads

Part No.	Wear Pad Screw	Wear Pad Driver	Admissible Tightening Torque*
WP7095	7358-IP10-1	8IP-10	27.0 in-lbs (300 N-cm)

*Tightening torques are calculated with a friction coefficient of $\mu = 0.14$ and develop 90% of ultimate yield strength

Pilot Accessories

Pilot Style	Series	Insert Screws	Insert Driver	Admissible Tightening Torque*
T-A	2	7495-IP15-1	8IP-15	61.0 in-lbs (690 N-cm)
GEN3SYS	32	7495-IP15-1	8IP-15	61.0 in-lbs (690 N-cm)

*Tightening torques are calculated with a friction coefficient of $\mu = 0.14$ and develop 90% of ultimate yield strength

Nonstocked diameters are also available. Follow the examples shown below.

A50: 28 - 29	A50: 2 - 5	Section A20	Section A25 & A30

Key on A50: 1

Inch	38 series, T-A (1 series), 1.6790"	Part No. = V3801D-1.6790
Metric	38 series, T-A (1 series), 42.15 mm	Part No. = V3801D-42.15

Wear pads sold in multiples of 2 | Wear pad screws sold in multiples of 4
IC inserts sold in multiples of 2 | Insert screws sold in multiples of 10

A DRILLING
B BORING
C REAMING
D BURISHING
E THREADING
X SPECIALS

APX Drill Holders

95 Series | Diameter Range: 3.740" - 4.000" (95.00 mm - 101.60 mm)

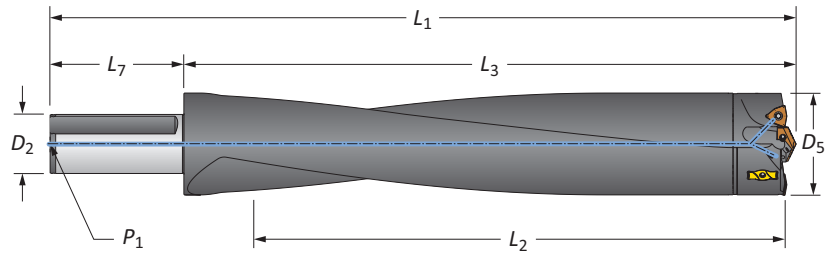

Straight Shank

	Length	D ₅		Body			Shank		Part No.	
		inch	mm	L ₂	L ₃	L ₁	L ₇	D ₂		P ₁
i	3xD	3.740 - 4.000	95.00 - 101.60	11-7/8	14-9/32	18-25/32	4-1/2	2	1/4 NPT	W9503H-200F
	5xD	3.740 - 4.000	95.00 - 101.60	20	22-19/64	26-51/64	4-1/2	2	1/4 NPT	W9505H-200F
	8xD	3.740 - 4.000	95.00 - 101.60	27-1/2	29-51/64	34-19/64	4-1/2	2	1/4 NPT	W9508H-200F
m	3xD	3.740 - 4.000	95.00 - 101.60	302.01	362.79	442.80	80.00	50.00	1/4 BSPT	W9503H-50FM
	5xD	3.740 - 4.000	95.00 - 101.60	508.00	566.19	646.20	80.00	50.00	1/4 BSPT	W9505H-50FM
	8xD	3.740 - 4.000	95.00 - 101.60	699.00	756.69	836.70	80.00	50.00	1/4 BSPT	W9508H-50FM

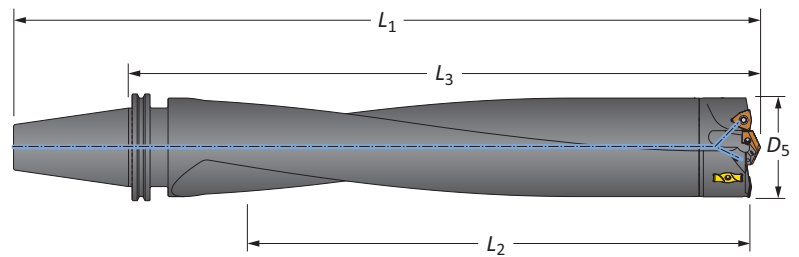

CV50 Shank

	Length	D ₅		Body			Shank	Part No.
		inch	mm	L ₂	L ₃	L ₁		
i	3xD	3.740 - 4.000	95.00 - 101.60	11-7/8	15-43/64	19-43/64	CV50	W9503H-CV50
	5xD	3.740 - 4.000	95.00 - 101.60	20	23-43/64	27-43/64	CV50	W9505H-CV50
	8xD	3.740 - 4.000	95.00 - 101.60	26-5/8	30-9/32	34-9/32	CV50	W9508H-CV50

Connection Accessories

Mounting Screw	Mounting Screw Bit	Admissible Tightening Torque*
78027-IP30-1	8IP-30B	250 in-lb (2825 N-cm)

*Tightening torques are calculated with a friction coefficient of $\mu = 0.14$ and develop 90% of ultimate yield strength

⚠ WARNING Refer to Speed and Feed charts for recommended adjustments to speeds and feeds. Refer to page A50: 30 for deep hole drilling guidelines in this section of the catalog. Visit www.alliedmachine.com/DeepHoleGuidelines for the most up-to-date information and procedures. Factory technical assistance is available for your specific applications through our Application Engineering Team.
ext: 7611 | email: appeng@alliedmachine.com

i = Imperial (in)
m = Metric (mm)

Mounting screws sold in multiples of 4

Recommended Drilling Data | Imperial (inch)

ISO	Material	Hardness (BHN)	Feed Rate (IPR) by Diameter								
			Outboard Insert		5/16" IC	3/8" IC	1/2" IC	9/16" IC	3/8" IC	1/2" IC	9/16" IC
			Series		33	38 - 44	44 - 51	51 - 57 - 63	70	76 - 83	89 - 95
			Speed (SFM)	Pilot Style	1.299" - 1.495"	1.496" - 1.885"	1.886" - 2.210"	2.211" - 2.755"	2.756" - 2.992"	2.992" - 3.503"	3.504" - 4.000"
P	Free-Machining Steel 1118, 1215, 12L14, etc.	100 - 250	450 - 750	T-A/GEN3SYS	.006 - .011	.007 - .012	.009 - .012	.009 - .012	.006 - .010	.007 - .011	.007 - .012
	Low-Carbon Steel 1010, 1020, 1025, 1522, 1144, etc.	85 - 275	450 - 750	T-A/GEN3SYS	.006 - .011	.007 - .012	.009 - .012	.009 - .012	.006 - .010	.007 - .011	.007 - .012
	Medium-Carbon Steel 1030, 1040, 1050, 1527, 1140, 1151, etc.	125 - 325	450 - 750	T-A/GEN3SYS	.006 - .011	.007 - .012	.009 - .012	.009 - .012	.006 - .010	.007 - .011	.007 - .012
	Alloy Steel 4140, 5140, 8640, etc.	125 - 375	400 - 700	T-A/GEN3SYS	.005 - .007	.005 - .009	.007 - .010	.007 - .011	.005 - .009	.006 - .010	.006 - .010
	High-Strength Alloy 4340, 4330V, 300M, etc.	225 - 400	300 - 500	T-A/GEN3SYS	.005 - .006	.005 - .007	.005 - .008	.006 - .009	.005 - .007	.005 - .008	.006 - .008
	Structural Steel A36, A285, A516, etc.	100 - 350	450 - 750	T-A/GEN3SYS	.006 - .008	.007 - .009	.008 - .010	.009 - .011	.005 - .009	.006 - .010	.007 - .010
	Tool Steel H-13, H-21, A-4, O-2, S-3, etc.	150 - 250	300 - 500	T-A/GEN3SYS	.005 - .006	.005 - .007	.007 - .009	.008 - .010	.005 - .007	.006 - .009	.007 - .010
S	High-Temp Alloy Hastelloy B, Inconel 600, etc.	140 - 310	200 - 400	T-A	.004 - .005	.004 - .007	.006 - .009	.007 - .009	.004 - .006	.005 - .007	.005 - .007
	Titanium Alloy	140 - 310	300 - 500	T-A	.005 - .007	.006 - .008	.007 - .009	.008 - .010	.004 - .006	.005 - .007	.005 - .007
	Aerospace Alloy S82	185 - 350	400 - 600	T-A/GEN3SYS	.004 - .006	.005 - .007	.006 - .008	.006 - .008	.004 - .006	.005 - .007	.005 - .007
M	Stainless Steel 400 Series 416, 420, etc.	185 - 350	300 - 500	T-A/GEN3SYS	.006 - .008	.007 - .009	.008 - .010	.009 - .011	.005 - .007	.007 - .009	.007 - .010
	Stainless Steel 300 Series 304, 316, 17-4PH, etc.	135 - 275	300 - 500	T-A/GEN3SYS	.005 - .007	.006 - .008	.007 - .009	.008 - .010	.004 - .008	.006 - .010	.006 - .010
	Super Duplex Stainless Steel	135 - 275	250 - 450	T-A/GEN3SYS	.004 - .006	.005 - .007	.007 - .009	.007 - .009	.004 - .007	.006 - .009	.007 - .010
H	Wear Plate Hardox®, AR400, T-1, etc.	400 - 600	300 - 500	T-A	.003 - .005	.004 - .006	.006 - .008	.007 - .009	.003 - .005	.004 - .006	.004 - .006
	Hardened Steel	300 - 500	300 - 500	T-A	.004 - .005	.005 - .006	.006 - .008	.006 - .008	.003 - .005	.004 - .006	.004 - .006
K	Nodular, Grey, Ductile Cast Iron	120 - 320	500 - 800	T-A/GEN3SYS	.005 - .009	.006 - .010	.008 - .012	.010 - .012	.008 - .010	.009 - .011	.010 - .012
N	Cast Aluminum	30 - 180	600 - 800	T-A/GEN3SYS	.009 - .012	.010 - .014	.012 - .016	.012 - .016	.006 - .009	.008 - .011	.008 - .012
	Wrought Aluminum	30 - 180	600 - 800	T-A/GEN3SYS	.007 - .011	.008 - .012	.010 - .014	.010 - .014	.006 - .009	.008 - .011	.008 - .012
	Aluminum Bronze	100 - 250	400 - 700	T-A/GEN3SYS	.005 - .007	.005 - .008	.007 - .010	.009 - .011	.006 - .009	.007 - .010	.008 - .012
	Brass	30 - 100	800	T-A/GEN3SYS	.006 - .008	.007 - .009	.008 - .010	.009 - .012	.006 - .008	.007 - .009	.008 - .012
	Copper	60	700	T-A/GEN3SYS	.002 - .005	.003 - .006	.006 - .008	.008 - .010	.006 - .008	.006 - .008	.006 - .008

Coolant Recommendations

Series	Pressure (PSI)	Flow Rate (GPM)
33	350	10
38	300	10
44	275	12
51	250	18
57	225	20
63	200	22
70	150	25
76	100	28
83	100	30
89	100	33
95	100	33

Calculations

Value	Formula
SFM	$RPM \cdot 0.262 \cdot \text{Diameter}$
RPM	$(SFM \cdot 3.82) / \text{Diameter}$
IPM	$RPM \cdot \text{IPR}$

IMPORTANT: The speeds and feeds listed above are a general starting point for all applications. Refer to the Coolant Recommendation charts for coolant requirements to run at the recommended speeds and feeds. Factory technical assistance is also available through our Application Engineering Team. ext: 7611 | email: appeng@alliedmachine.com

IMPORTANT: The coolant pressure and flow rate recommendations above represent a good approximation to obtain optimum tool life and chip evacuation at Allied Machine recommended speeds and feeds. If lower coolant capabilities exist in a drilling application, the APX Drilling System will still function at reduced penetration rates. Contact our Application Engineering department for a more specific recommendation of coolant requirements and/or speeds and feeds.

⚠ WARNING Tool failure can cause serious injury. To prevent: For APX holders 8xD or longer, do not rotate tool more than 50 RPM unless it is engaged with workpiece or fixture. Refer to page A50: 30 for Deep Hole Drilling Guidelines in this section of the catalog. Visit www.alliedmachine.com/DeepHoleGuidelines for the most up-to-date information and procedures. Factory technical assistance is also available for your specific applications.

Recommended Drilling Data | Metric (mm)

ISO	Material	Hardness (BHN)	Outboard Insert		Feed Rate (mm/rev) by Diameter						
			Series		5/16" IC	3/8" IC	1/2" IC	9/16" IC	3/8" IC	1/2" IC	9/16" IC
			Speed (M/min)	Pilot Style	33	38 - 44	44 - 51	51 - 57 - 63	70	76 - 83	89 - 95
P	Free-Machining Steel 1118, 1215, 12L14, etc.	100 - 250	137 - 229	T-A/GEN3SYS	0.15 - 0.28	0.18 - 0.30	0.23 - 0.30	0.23 - 0.30	0.15 - 0.25	0.18 - 0.28	0.18 - 0.30
	Low-Carbon Steel 1010, 1020, 1025, 1522, 1144, etc.	85 - 275	137 - 229	T-A/GEN3SYS	0.15 - 0.28	0.18 - 0.30	0.23 - 0.30	0.23 - 0.30	0.15 - 0.25	0.18 - 0.28	0.18 - 0.30
	Medium-Carbon Steel 1030, 1040, 1050, 1527, 1140, 1151, etc.	125 - 325	137 - 229	T-A/GEN3SYS	0.15 - 0.28	0.18 - 0.30	0.23 - 0.30	0.23 - 0.30	0.15 - 0.25	0.18 - 0.28	0.18 - 0.30
	Alloy Steel 4140, 5140, 8640, etc.	125 - 375	122 - 213	T-A/GEN3SYS	0.13 - 0.18	0.13 - 0.23	0.18 - 0.25	0.18 - 0.28	0.13 - 0.23	0.15 - 0.25	0.15 - 0.25
	High-Strength Alloy 4340, 4330V, 300M, etc.	225 - 400	91 - 152	T-A/GEN3SYS	0.13 - 0.15	0.13 - 0.18	0.13 - 0.20	0.15 - 0.23	0.13 - 0.18	0.13 - 0.20	0.15 - 0.20
	Structural Steel A36, A285, A516, etc.	100 - 350	137 - 229	T-A/GEN3SYS	0.15 - 0.20	0.18 - 0.23	0.20 - 0.25	0.23 - 0.28	0.13 - 0.23	0.15 - 0.25	0.15 - 0.25
	Tool Steel H-13, H-21, A-4, O-2, S-3, etc.	150 - 250	91 - 152	T-A/GEN3SYS	0.13 - 0.15	0.13 - 0.18	0.18 - 0.23	0.20 - 0.25	0.13 - 0.18	0.15 - 0.23	0.18 - 0.25
S	High-Temp Alloy Hastelloy B, Inconel 600, etc.	140 - 310	61 - 122	T-A	0.10 - 0.13	0.10 - 0.18	0.15 - 0.23	0.18 - 0.23	0.10 - 0.15	0.13 - 0.18	0.13 - 0.18
	Titanium Alloy	140 - 310	91 - 152	T-A	0.13 - 0.18	0.15 - 0.20	0.18 - 0.23	0.20 - 0.25	0.10 - 0.15	0.13 - 0.18	0.13 - 0.18
	Aerospace Alloy S82	185 - 350	122 - 183	T-A/GEN3SYS	0.10 - 0.15	0.13 - 0.18	0.15 - 0.20	0.15 - 0.20	0.10 - 0.15	0.13 - 0.18	0.13 - 0.18
M	Stainless Steel 400 Series 416, 420, etc.	185 - 350	91 - 152	T-A/GEN3SYS	0.15 - 0.20	0.18 - 0.23	0.20 - 0.25	0.23 - 0.28	0.13 - 0.18	0.18 - 0.23	0.18 - 0.25
	Stainless Steel 300 Series 304, 316, 17-4PH, etc.	135 - 275	91 - 152	T-A/GEN3SYS	0.13 - 0.18	0.15 - 0.20	0.18 - 0.23	0.20 - 0.25	0.10 - 0.20	0.15 - 0.25	0.15 - 0.25
	Super Duplex Stainless Steel	135 - 275	76 - 137	T-A/GEN3SYS	0.10 - 0.15	0.13 - 0.18	0.18 - 0.23	0.18 - 0.23	0.10 - 0.18	0.15 - 0.23	0.18 - 0.25
H	Wear Plate Hardox®, AR400, T-1, etc.	400 - 600	91 - 152	T-A	0.07 - 0.13	0.10 - 0.15	0.15 - 0.20	0.18 - 0.23	0.08 - 0.13	0.10 - 0.15	0.10 - 0.15
	Hardened Steel	300 - 500	91 - 152	T-A	0.10 - 0.13	0.13 - 0.15	0.15 - 0.20	0.15 - 0.20	0.08 - 0.13	0.10 - 0.20	0.10 - 0.20
K	Nodular, Grey, Ductile Cast Iron	120 - 320	152 - 244	T-A/GEN3SYS	0.13 - 0.23	0.15 - 0.25	0.20 - 0.30	0.25 - 0.30	0.20 - 0.25	0.23 - 0.28	0.25 - 0.30
N	Cast Aluminum	30 - 180	183 - 244	T-A/GEN3SYS	0.23 - 0.30	0.25 - 0.36	0.30 - 0.40	0.30 - 0.40	0.15 - 0.23	0.20 - 0.28	0.20 - 0.30
	Wrought Aluminum	30 - 180	183 - 244	T-A/GEN3SYS	0.18 - 0.28	0.20 - 0.30	0.25 - 0.36	0.25 - 0.36	0.15 - 0.23	0.20 - 0.28	0.20 - 0.30
	Aluminum Bronze	100 - 250	123 - 213	T-A/GEN3SYS	0.13 - 0.18	0.13 - 0.20	0.18 - 0.25	0.23 - 0.28	0.15 - 0.23	0.18 - 0.25	0.20 - 0.30
	Brass	30 - 100	244	T-A/GEN3SYS	0.15 - 0.20	0.18 - 0.23	0.20 - 0.25	0.23 - 0.30	0.15 - 0.20	0.18 - 0.23	0.20 - 0.25
	Copper	60	213	T-A/GEN3SYS	0.05 - 0.13	0.08 - 0.15	0.15 - 0.20	0.20 - 0.25	0.08 - 0.15	0.15 - 0.20	0.15 - 0.20

Coolant Recommendations

Series	Pressure (BAR)	Flow Rate (LPM)
33	24	38
38	21	38
44	19	45
51	17	68
57	16	76
63	14	83
70	10	95
76	7	106
83	7	114
89	7	125
95	7	125

Calculations

Value	Formula
M/min	RPM • 0.003 • Diameter
RPM	(M/min • 318.47) / Diameter
mm/min	RPM • mm/rev

IMPORTANT: The speeds and feeds listed above are a general starting point for all applications. Refer to the Coolant Recommendation charts for coolant requirements to run at the recommended speeds and feeds. Factory technical assistance is also available through our Application Engineering Team. ext: 7611 | email: appeng@alliedmachine.com

IMPORTANT: The coolant pressure and flow rate recommendations above represent a good approximation to obtain optimum tool life and chip evacuation at Allied Machine recommended speeds and feeds. If lower coolant capabilities exist in a drilling application, the APX Drilling System will still function at reduced penetration rates. Contact our Application Engineering department for a more specific recommendation of coolant requirements and/or speeds and feeds.

⚠ WARNING Tool failure can cause serious injury. To prevent: For APX holders 8xD or longer, do not rotate tool more than 50 RPM unless it is engaged with workpiece or fixture. Refer to page A50: 30 for Deep Hole Drilling Guidelines in this section of the catalog. Visit www.alliedmachine.com/DeepHoleGuidelines for the most up-to-date information and procedures. Factory technical assistance is also available for your specific applications.

A
DRILLING
B
BORING
C
REAMING
D
BURNISHING
E
THREADING
X
SPECIALS



Deep Hole Drilling Guidelines

A

DRILLING



1. Approach
50 RPM max
12 IPM (300 mm/min)

Feed the longer drill within 1/16" (1.5 mm) short of the workpiece at a **maximum of 50 RPM** and 12 IPM (300 mm/min) feed rate.

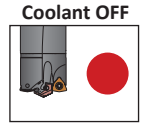
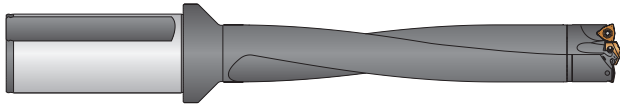

B

BORING

2. Feed-in
Speed at 75% of recommended start
Feed at 50% of recommended start

Drill 3/4" deep at 75% recommended speed and 50% recommended feed to establish the hole.

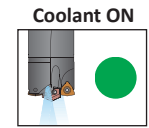
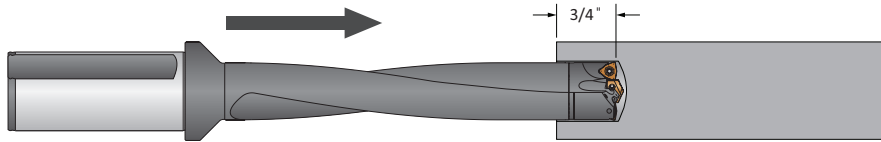

C

REAMING

3. Deep Hole Drilling - Blind
100 % RPM
100% IPR (mm/rev)

Drill to full depth at recommended speed and feed for longer drills (according to Allied Machine speed and feed charts).
***No peck cycle recommended.**

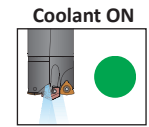
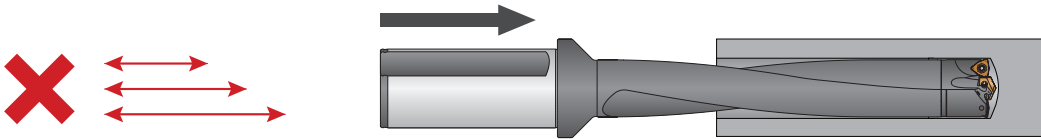

D

BURNISHING

4. Deep Hole Drilling - at Breakout
50% RPM
100% IPR (mm/rev)

***For through holes only:**
Reduce speed by 50% prior to breakout.
Do not break out more than 1/8" (3 mm) past the full diameter of the drill.

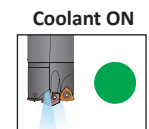
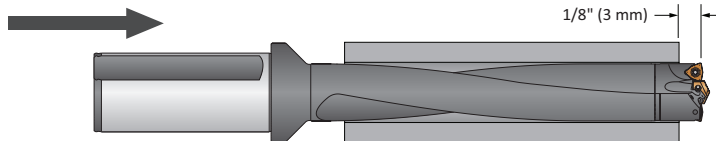

E

THREADING



5. Drill Retract
50 RPM max

Reduce speed to a **maximum of 50 RPM** before retracting from the hole.

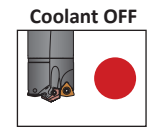
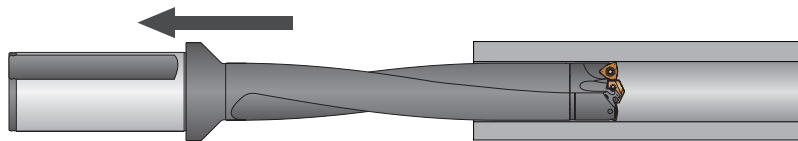

X

SPECIALS

⚠ WARNING Tool failure can cause serious injury. To prevent: NEVER rotate these tool holders more than 50 RPM without proper engagement with a workpiece or fixture. Failure to do so could result in tool failure and/or personal injury. Visit www.alliedmachine.com/DeepHoleGuidelines for the most up-to-date information and procedures. Factory technical assistance is also available for your specific applications.
ext: 7611 | email: appeng@alliedmachine.com

Guaranteed Test / Demo Application Form

Distributor PO #

The following must be filled out completely before your test will be considered

Distributor Information

Company Name: _____
 Contact: _____
 Account Number: _____
 Phone: _____
 Email: _____

End User Information

Company Name: _____
 Contact: _____
 Industry: _____
 Phone: _____
 Email: _____

Current Process List all tooling, coatings, substrates, speeds and feeds, tool life, and any problems you are experiencing

Test Objective List what would make this a successful test (i.e. penetration rate, finish, tool life, hole size, etc.)

Application Information

Hole Diameter: _____ in/mm	Tolerance: _____	Material: _____ (4150 / A36 / Cast Iron / etc.)
Required Finish: _____ RMS	_____ in/mm	Hardness: _____ (BHN / Rc)
		State: _____ (Casting / Hot rolled / Forging)

Machine Information

Machine Type: _____ (Lathe / Screw machine / Machine center / etc.)	Builder: _____ (Haas, Mori Seiki, etc.)	Model #: _____
Shank Required: _____ (CAT50 / Flanged)		Power: _____ HP/KW
Rigidity: _____	Orientation: _____	Tool Rotating: _____
<input type="checkbox"/> Excellent	<input type="checkbox"/> Vertical	<input type="checkbox"/> Yes
<input type="checkbox"/> Good	<input type="checkbox"/> Horizontal	<input type="checkbox"/> No
<input type="checkbox"/> Poor		Thrust: _____ lbs/N

Coolant Information

Coolant Delivery: _____ (Through tool / Flood)	Coolant Pressure: _____ PSI / bar
Coolant Type: _____ (Air mist, oil, synthetic, water soluble, etc.)	Coolant Volume: _____ GPM / LPM

Requested Tooling

QTY	Item Number	QTY	Item Number



Allied Machine & Engineering
 120 Deeds Drive
 Dover, OH 44622

Telephone: (330) 343-4283
 Toll Free USA & Canada: (800) 321-5537
 Fax: (330) 602-3400

Warranty Information



Allied Machine & Engineering ("Allied Machine") warrants to original equipment manufacturers, distributors, industrial and commercial users of its products for one year from the original date of sale that each new product manufactured or supplied by Allied Machine shall be free from defects in material and workmanship.

Allied Machine's sole and exclusive obligation under this warranty is limited to, at its option, without additional charge, replacing or repairing this product or issuing a credit. For this warranty to be applied, the product must be returned freight prepaid to the plant designated by an Allied Machine representative and which, upon inspection, is determined by Allied Machine to be defective in material and workmanship.

Complete information as to operating conditions, machine, setup, and the application of cutting fluid should accompany any product returned for inspection. This warranty shall not apply to any Allied Machine products which have been subjected to misuse, abuse, improper operating conditions, improper machine setup or improper application of cutting fluid or which have been repaired or altered if such repair or alteration, in the judgement of Allied Machine, would adversely affect the performance of the product.

THIS WARRANTY IS IN LIEU OF ALL OTHER WARRANTIES, EXPRESS OR IMPLIED, INCLUDING ANY IMPLIED WARRANTY OF MERCHANTABILITY OR FITNESS FOR A PARTICULAR PURPOSE. Allied Machine shall have no liability or responsibility for any claim, whether in contract, tort or otherwise, for any loss or damage arising out of, connected with, or resulting from the manufacture, sale, delivery or use of any product sold hereunder, in excess of the cost of replacement or repair as provided herein.

Allied Machine shall not be liable in contract or in tort (including, without limitation, negligence, strict liability or otherwise) for economic losses of any kind or for any special, incidental, indirect, consequential, punitive or exemplary damages arising in any way out of the performance of, or failure to perform this agreement.

ALL PRICES, DELIVERIES, DESIGNS, AND MATERIALS ARE SUBJECT TO CHANGE WITHOUT NOTICE.



Allied Machine & Engineering
is registered to
ISO 9001:2015 by DQS

United States

Allied Machine & Engineering

120 Deeds Drive
Dover OH 44622
United States

Phone:
+1.330.343.4283

Fax:
+1.330.602.3400

Toll Free USA and Canada:
800.321.5537

Toll Free USA and Canada:
800.223.5140

Allied Machine & Engineering

485 W Third Street
Dover OH 44622
United States

Phone:
+1.330.343.4283

Fax:
+1.330.364.7666
(Engineering Dept.)

Toll Free USA and Canada:
800.321.5537

Europe

Allied Machine & Engineering Co. (Europe) Ltd.

93 Vantage Point
Pensnett Estate
Kingswinford
West Midlands
DY6 7FR England

Phone:
+44 (0) 1384.400900

Wohlhaupter GmbH

Maybachstrasse 4
Postfach 1264
72636 Frickenhausen
Germany

Phone:
+49 (0) 7022.408.0

Fax:
+49 (0) 7022.408.212

Asia

Wohlhaupter India Pvt. Ltd.

B-23, 3rd Floor
B Block Community Centre
Janakpuri, New Delhi - 110058
India

Phone:
+91 (0) 11.41827044

Your local Allied Machine representative:

www.alliedmachine.com

Allied Machine & Engineering is registered to ISO 9001:2015 by DQS



Copyright © 2022 Allied Machine & Engineering Corp. All rights reserved.
All trademarks designated with the ® symbol are registered in the United States and other countries.
Available Online Only
Publish Date: August 2022