



ALLIED MACHINE & ENGINEERING

Holemaking Solutions for Today's Manufacturing



Boring



Reaming



Burnishing



Threading



Specials



GEN3SYS[®] XT & XT Pro

► *DRILLING*

Replaceable Insert Drilling System

SECTION

A20

GEN3SYS® XT & XT Pro

GEN3SYS® XT and XT Pro

High Penetration Replaceable Insert Drilling System | GEN3SYS XT | GEN3SYS XT Pro

► **Diameter Range:** 0.4331" - 1.3780" (11.00 mm - 35.00 mm)



The Next Generation of Drilling

The GEN3SYS XT and XT Pro replaceable insert high penetration drilling system has been designed to provide high-speed production machining beyond the capabilities of the T-A® drilling system. The product offering consists of various grades, geometries, and coatings available to suit the most demanding applications.

Conceived from the outset as the ultimate high performance drilling solution, the GEN3SYS XT drill range is incredibly versatile. Incorporating both straight and helical fluted tool holder options across the range, as well as through coolant for maximum material removal, GEN3SYS XT not only gives outstanding performance from day one, but it can also be reground for extended life and economy.

Excellent chip control	Improves hole quality and surface finish	Provides maximum durability and stability
------------------------	--	---

Applicable Industries

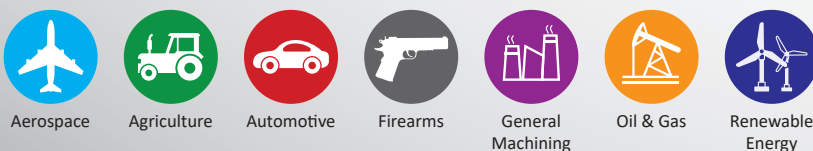

Your safety and the safety of others is very important. This catalog contains important safety messages. Always read and follow all safety precautions.



This triangle is a safety hazard symbol. It alerts you to potential safety hazards that can cause tool failure and serious injury.

When you see this symbol in the catalog, look for a related safety message that may be near this triangle or referred to in the nearby text.

There are safety signal words also used in the catalog. Safety messages follow these words.

WARNING

WARNING (shown above) means that failure to follow the precautions in this message could result in tool failure and serious injury.

NOTICE means that failure to follow the precautions in this message could result in damage to the tool or machine but not result in personal injury.

NOTE and **IMPORTANT** are also used. These are important that you read and follow but are not safety-related.

Visit www.alliedmachine.com for the most up-to-date information and procedures.

GEN3SYS® XT and XT Pro Drilling System Contents

Reference Icons

The following icons will appear throughout the catalog to help you navigate between products.



Setup / Assembly Information

Detailed instructions and information regarding the corresponding part(s)

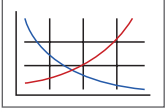

Recommended Cutting Data

Speed and feed recommendations for optimum and safe boring



Coolant-Through Option

Indicates that the product is coolant through

Series	Diameter Range	
	Imperial (inch)	Metric (mm)
11	0.4331 - 0.4723	11.00 - 11.99
12	0.4724 - 0.5117	12.00 - 12.99
13	0.5118 - 0.5511	13.00 - 13.99
14	0.5512 - 0.5905	14.00 - 14.99
15	0.5906 - 0.6298	15.00 - 15.99
16	0.6299 - 0.6692	16.00 - 16.99
17	0.6693 - 0.7086	17.00 - 17.99
18	0.7087 - 0.7873	18.00 - 19.99
20	0.7874 - 0.8660	20.00 - 21.99
22	0.8661 - 0.9448	22.00 - 23.99
24	0.9449 - 1.0235	24.00 - 25.99
26	1.0236 - 1.1416	26.00 - 28.99
29	1.1417 - 1.2597	29.00 - 31.99
32	1.2598 - 1.3780	32.00 - 35.00

Introduction Information

Why You Should Use the Pro	2 - 3
Test Results and Case Study	4 - 5
GEN3SYS XT Pro Drilling System Information	6
GEN3SYS XT Drilling System Information	7
Insert Comparison and Assembly Details	8
Holder Comparison and Overview	9
Product Nomenclature	10 - 11

Drill Series

11 Series	12 - 15
12 Series	16 - 19
13 Series	20 - 23
14 Series	24 - 27
15 Series	28 - 31
16 Series	32 - 35
17 Series	36 - 39
18 Series	40 - 43
20 Series	44 - 47
22 Series	48 - 51
24 Series	52 - 55
26 Series	56 - 59
29 Series	60 - 63
32 Series	64 - 67

Recommended Cutting Data

Imperial (inch)	[GEN3SYS XT Pro	68 - 71
		GEN3SYS XT	72 - 75
Metric (mm)	[GEN3SYS XT Pro	76 - 79
		GEN3SYS XT	80 - 83

Tap Drill Conversions	84 - 85
Deep Hole Drilling Guidelines	86
Troubleshooting Guide	87

WHY SHOULD YOU

GO WITH THE PRO?

GEN3SYS® XT Pro



- ✓ Increase your penetration rates
- ✓ ISO-specific geometries
- ✓ Improved chip evacuation
- ✓ Increased coolant flow to the cutting zone
- ✓ AM420 coating increases heat resistance
- ✓ AM440 coating increases abrasion resistance

**THAT'S WHY YOU SHOULD
GO WITH THE PRO.**

Project Profile: Forged 8640
Tooling Solution: GEN3SYS XT Pro: P (Steel) Geometry

The Problem:
Previously, the customer was using a competitor drill running at the following parameters:

- 415 SFM (127 M/min)
- 0.009 IPR (0.23 mm/rev)
- The tool drilled a 17.25mm diameter hole to a 20mm depth
- Tool life = **1,000 holes**

The Solution:
Allied Machine recommended the GEN3SYS XT Pro with P (Steel) geometry.

- **Insert** = XTP17-17.25

The tool ran at the following parameters:

- 415 SFM (127 M/min)
- 0.009 IPR (0.23 mm/rev)
- The tool drilled a 17.25mm diameter hole to a 20mm depth
- Tool life = **2,100 holes**

The Advantage:
The GEN3SYS XT Pro increased the tool life from 1,000 holes to 2,100 holes.
Bottom Line: *Doubled the tool life*

The PROOF is in the NUMBERS

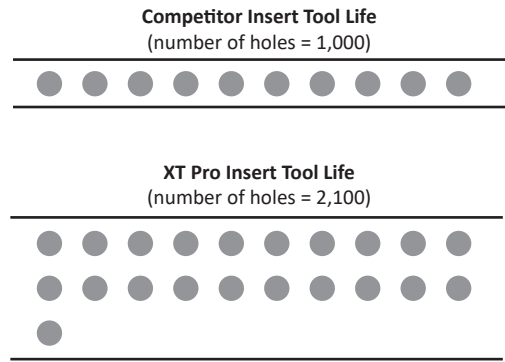

INCREASE in tool life
2x



HOLDER DESIGN

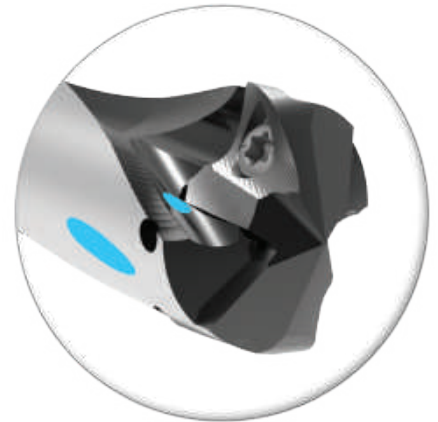

Drill deeper holes

The XT Pro holders are available up to 12xD.

- ▶ **This lets you take advantage of the XT Pro insert benefits in deep hole applications.**

Increase your tool life

The coolant configuration increases coolant flow and directs additional coolant to the cutting zone.

- ▶ **This increases tool life with all XT Pro inserts.**

Competitive Test Results

A
DRILLING
B
BORING
C
REAMING
D
BURNISHING
E
THREADING
X
SPECIALS

TEST RESULTS

Project Profile: Competitive Testing in 4150 Steel
Tooling Solution: GEN3SYS XT Pro: (P) steel geometry with XT Pro Holder

The Parameters:

- Hole Diameter = 0.748" (19 mm)
- Depth of Cut = 1-1/2" (38.1 mm)
- Coolant = 300 PSI
- Speed = 1583 RPM
- Feed = 22.16 inch/min (563 mm/min)

The Results:

When run at the listed parameters, here is how the three different tooling solutions performed:

Competitor 1 = 2478 total linear inches
Competitor 2 = 3317 total linear inches
GEN3SYS XT Pro = 4224 total linear inches

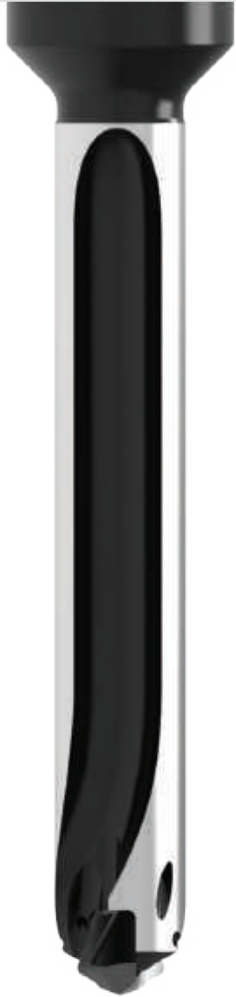

Average Tool Life
 Test Results Drilling in 4150 Steel

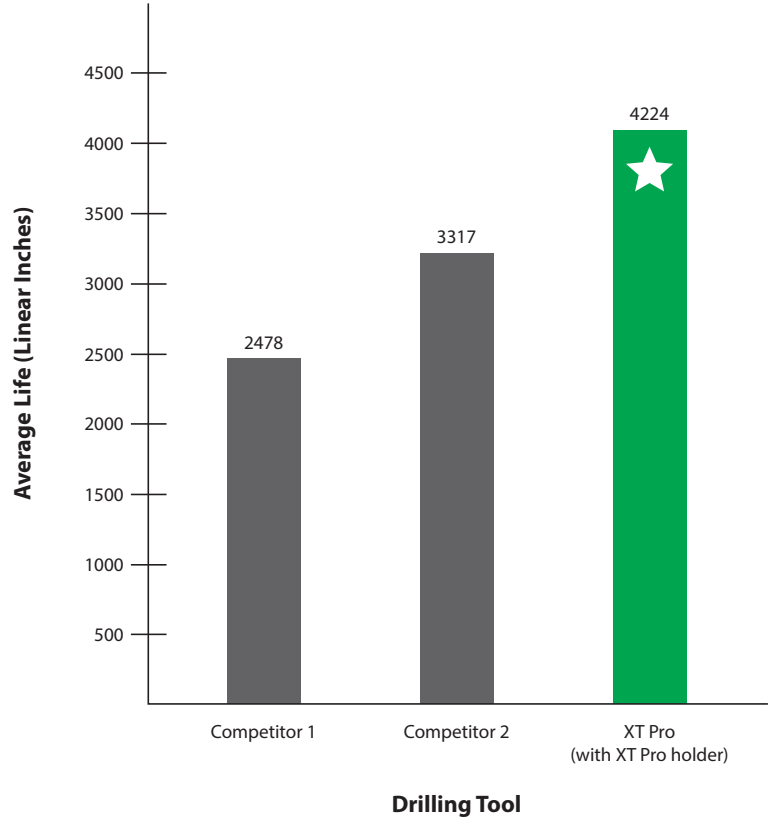

Case Study Example

CASE STUDY

Project Profile: Ductile/Nodular Iron
Tooling Solution: GEN3SYS XT Pro: K (cast iron) geometry

The Problem:
 Previously, the customer was using a competitor drill:
 • Solid carbide drill
 • Tool life = 65 holes

The Solution:
 Allied Machine recommended the GEN3SYS XT Pro with K (cast iron) geometry. The tool ran at the following parameters:
 • Hole Diameter = 9/16"
 • Coolant = None
 • Speed = 390 SFM (117 M/min)
 • Feed = 0.008 IPR (0.20 mm/rev)
 • Tool life = 390 holes

The Advantage:
 The GEN3SYS XT Pro increased the tool life from 65 holes to 390 holes.
Bottom Line: 6x the tool life

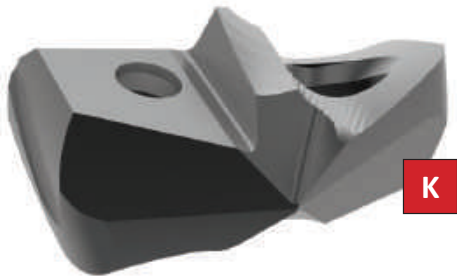

There's More to the Advantage than Tool Life

The XT Pro replaceable tip system provides other benefits in addition to the increase in tool life over the solid carbide drill:

- Because only the insert needs changed when it reaches the end of its life, the XT Pro eliminates the need to re-establish tool lengths, which reduces setup times.
- Further benefit in setup is also seen as the tool only needs changed one time for every six of the customer's current method.
- Without the need for regrinds, the customer's stock of tooling is reduced by eliminating the need for float inventory to cover regrind lead time.

The PROOF is in the NUMBERS

Competitor Tool Life
 (number of holes = 65)



XT Pro Tool Life
 (number of holes = 390)

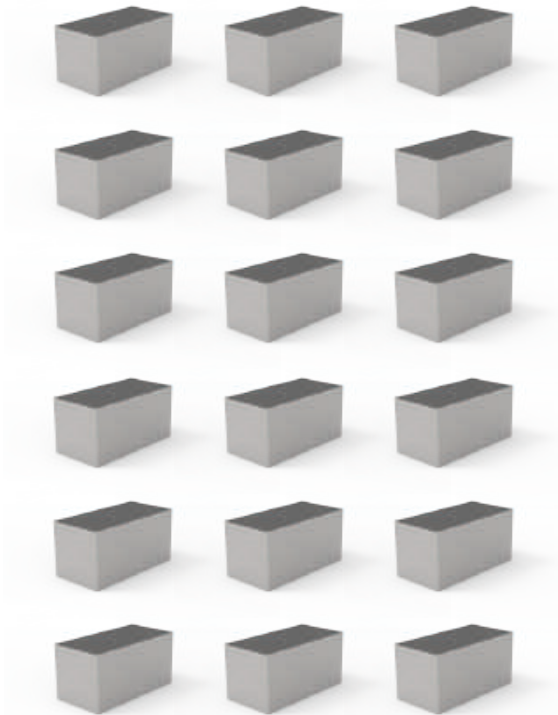

INCREASE in
6x tool life

A
DRILLING
B
BORING
C
REAMING
D
BURNISHING
E
THREADING
X
SPECIALS

GEN3SYS XT Pro Drilling System Information

A DRILLING
B BORING
C REAMING
D BURNISHING
E THREADING
X SPECIALS

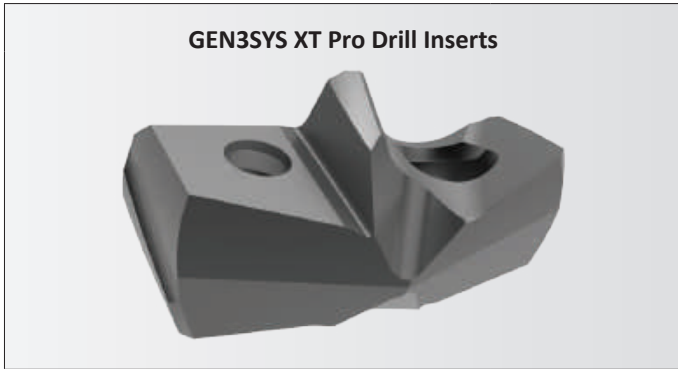

Advanced Design Capabilities

The advanced XT Pro insert combines a coating and geometry specifically designed to achieve optimal results in ISO material drilling applications. With quick connectivity to existing GEN3SYS drill insert holders, the XT Pro insert can be interchanged with previous XT inserts with ease, resulting in minimal setup times so you can immediately increase your productivity.

XT Pro Inserts Connect with:

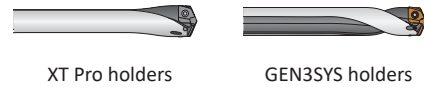

P - Steels

- Designed to provide increased penetration rates and tool life in steel applications
- Superior geometry and edge provides excellent chip control
- Allied's multilayer AM420 coating increases heat resistance and improves tool life

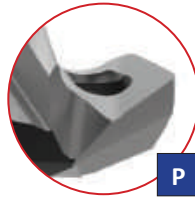

N - Nonferrous Materials

- Designed for applications in aluminum, brass, and copper
- The geometry yields excellent chip control in these softer materials
- TiN coating gives the versatility to run in a variety of materials while reducing buildup

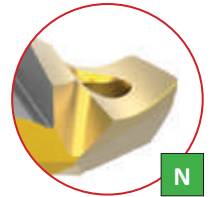

K - Cast Irons

- Uniquely designed for cast/nodular iron applications
- Geometry includes a corner radius for improved hole finish and heat dispersion
- Allied's multilayer AM440 coating provides increased abrasion resistance and tool life

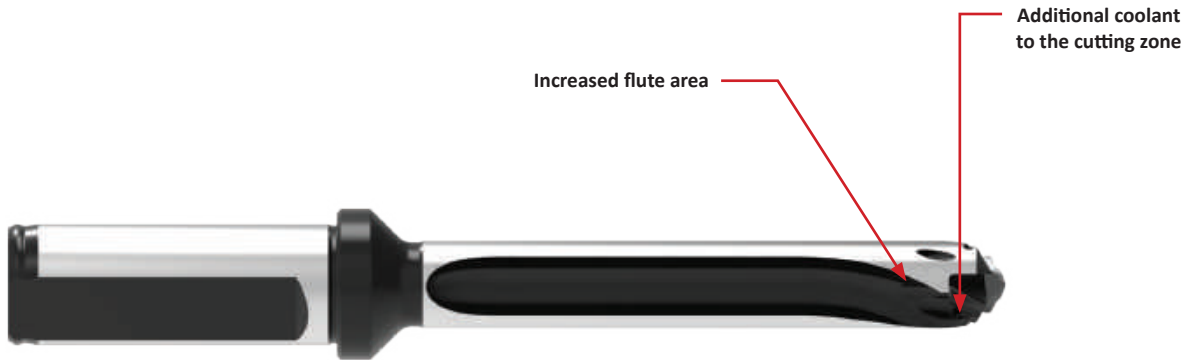

XT Pro Drill Holders

			3xD, 5xD, 7xD, 10xD, 12xD
Straight flutes	Enhanced coolant inlets improve the coolant flow	Provides increased insert life	Available in 3xD, 5xD, 7xD, 10xD, and 12xD

GEN3SYS XT Drilling System Information

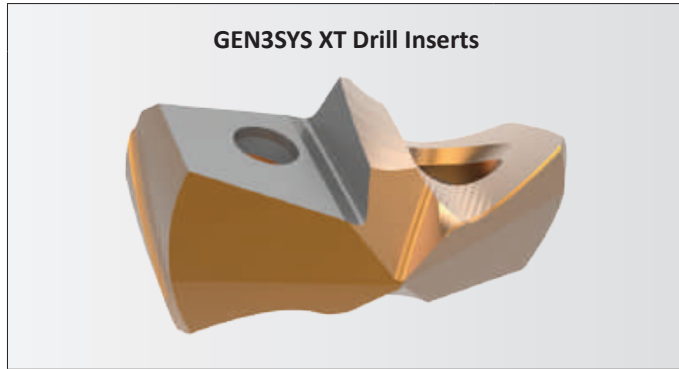

High Penetration Drilling Solutions

The unique geometry of the XT inserts provides excellent chip control. They are designed to increase hole quality, surface finish, and true position when compared to other competitive products. The helical margin design provides maximum durability and stability.

XT Inserts Connect with:



Standard Geometry

- Designed with corner and cutting edge enhancements to deliver more reliability, durability, and productivity
- Increases penetration rates and tool life
- Available in C1 or C2 carbide



LR - Low Rake Geometry

- The toughest XT geometry available
- Designed for harder steels and less than ideal machining applications
- Available in C1 or C2 carbide

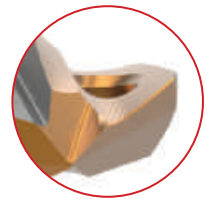

CI - Cast Iron Geometry

- Increases durability and tool life in ductile, nodular, and grey cast irons
- Available in C2 carbide



AS - Stainless Steel Geometry

- Designed with a specific geometry to provide unmatched chip control and tool life in austenitic and PH stainless steels, as well as high temperature alloys such as Inconel, Hastelloy, and titanium alloys
- Available in C2 carbide

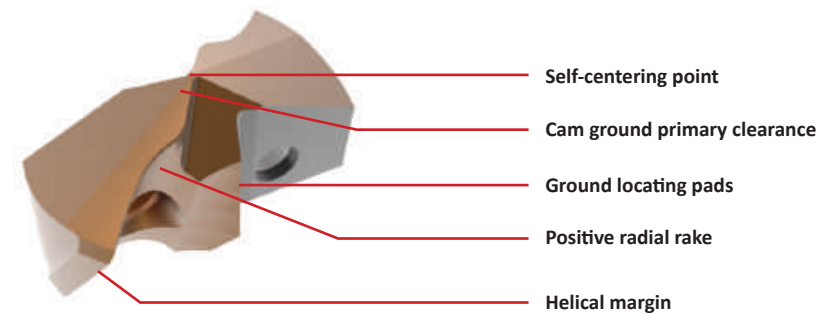

Coating	Features / Benefits
AM300®	<ul style="list-style-type: none"> • Increased heat resistance over AM200® coating • Up to 20% increased tool life over AM200 coating • Provides superior tool life at high penetration rates



GEN3SYS Holders

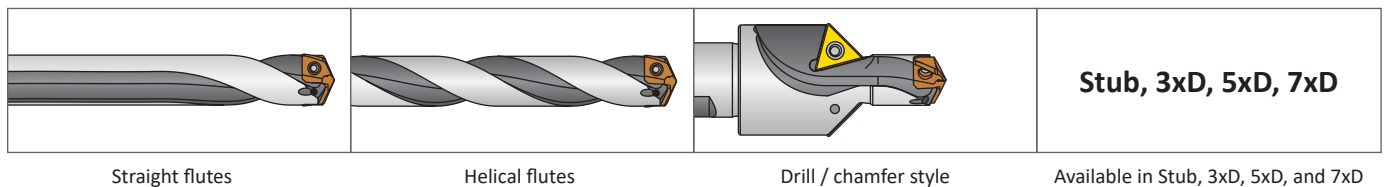







Straight flutes

Helical flutes

Drill / chamfer style

Available in Stub, 3xD, 5xD, and 7xD

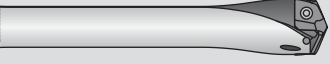
Insert Comparison and Assembly Information

		XT Pro Inserts	XT Inserts
A DRILLING			
		XT Pro Inserts	XT Inserts
B BORING	Recommended for increased productivity		<input checked="" type="checkbox"/>
	ISO-specific geometry/coating combination		<input checked="" type="checkbox"/>
C REAMING	Connects with XT Pro holders		<input checked="" type="checkbox"/>
	Connects with GEN3SYS holders		<input checked="" type="checkbox"/>



Step 1:
Align the flats on the GEN3SYS XT insert with the flats on the ears of the holder.







Step 2:
Slide the insert into the precision ground locating pocket on the holder. The insert should not be turned, rotated, or twisted for locking purposes. The holder pocket and locating pads on the insert assure optimum fit and repeatability.

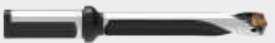

Step 3:
Apply a generous amount of E-Z Break® (provided in the packaging) onto the supplied TORX® Plus screws.

Tighten the TORX Plus screws to the recommended torque value specified in the catalog by series. A preset torx driver is available to assure that the proper torque is applied.

Holder Comparison and Overview

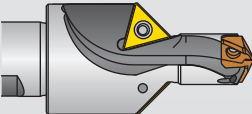
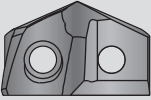
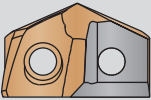
		 XT Pro Holders	 GEN3SYS Holders
Recommended for increased productivity		<input checked="" type="checkbox"/>	
Straight flute		<input checked="" type="checkbox"/>	<input checked="" type="checkbox"/>
Helical flute			<input checked="" type="checkbox"/>
Drill/chamfer option			<input checked="" type="checkbox"/>
Available in 12xD length	12XD	<input checked="" type="checkbox"/>	
Connects with XT Pro inserts		<input checked="" type="checkbox"/>	<input checked="" type="checkbox"/>
Connects with XT inserts		<input checked="" type="checkbox"/>	<input checked="" type="checkbox"/>

XT Pro Holders



Straight Flute

GEN3SYS Holders



Straight Flute



Helical Flute



Drill/Chamfer

Product Nomenclature

GEN3SYS XT Pro Drill Inserts

XT	P	11	–	11.00
1	2	3		4

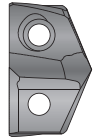

1. XT Pro Drill Insert	2. ISO Material / Geometry	3. Series	4. Diameter (mm)														
XT = XT Pro insert	P = Steel K = Cast iron N = Non-ferrous	<table border="0"> <tr> <td>11 = 11 series</td> <td>18 = 18 series</td> </tr> <tr> <td>12 = 12 series</td> <td>20 = 20 series</td> </tr> <tr> <td>13 = 13 series</td> <td>22 = 22 series</td> </tr> <tr> <td>14 = 14 series</td> <td>24 = 24 series</td> </tr> <tr> <td>15 = 15 series</td> <td>26 = 26 series</td> </tr> <tr> <td>16 = 16 series</td> <td>29 = 29 series</td> </tr> <tr> <td>17 = 17 series</td> <td>32 = 32 series</td> </tr> </table>	11 = 11 series	18 = 18 series	12 = 12 series	20 = 20 series	13 = 13 series	22 = 22 series	14 = 14 series	24 = 24 series	15 = 15 series	26 = 26 series	16 = 16 series	29 = 29 series	17 = 17 series	32 = 32 series	For complete list of diameter ranges by series, see contents page.
11 = 11 series	18 = 18 series																
12 = 12 series	20 = 20 series																
13 = 13 series	22 = 22 series																
14 = 14 series	24 = 24 series																
15 = 15 series	26 = 26 series																
16 = 16 series	29 = 29 series																
17 = 17 series	32 = 32 series																

GEN3SYS XT Drill Inserts

7	C2	12	P	–	.484	CI
1	2	3	4		5	6

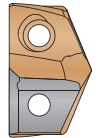

1. XT Drill Insert	2. Insert Material	3. Series	4. Coating														
7 = XT insert	C1 = C1 (K35) carbide C2 = C2 (K20) carbide	<table border="0"> <tr> <td>11 = 11 series</td> <td>18 = 18 series</td> </tr> <tr> <td>12 = 12 series</td> <td>20 = 20 series</td> </tr> <tr> <td>13 = 13 series</td> <td>22 = 22 series</td> </tr> <tr> <td>14 = 14 series</td> <td>24 = 24 series</td> </tr> <tr> <td>15 = 15 series</td> <td>26 = 26 series</td> </tr> <tr> <td>16 = 16 series</td> <td>29 = 29 series</td> </tr> <tr> <td>17 = 17 series</td> <td>32 = 32 series</td> </tr> </table>	11 = 11 series	18 = 18 series	12 = 12 series	20 = 20 series	13 = 13 series	22 = 22 series	14 = 14 series	24 = 24 series	15 = 15 series	26 = 26 series	16 = 16 series	29 = 29 series	17 = 17 series	32 = 32 series	P = AM300®
11 = 11 series	18 = 18 series																
12 = 12 series	20 = 20 series																
13 = 13 series	22 = 22 series																
14 = 14 series	24 = 24 series																
15 = 15 series	26 = 26 series																
16 = 16 series	29 = 29 series																
17 = 17 series	32 = 32 series																

5. Diameter	6. Geometry
0017 = Inch .515 = Decimal 13 = Metric	CI = Cast iron LR = Low rake AS = Stainless steel

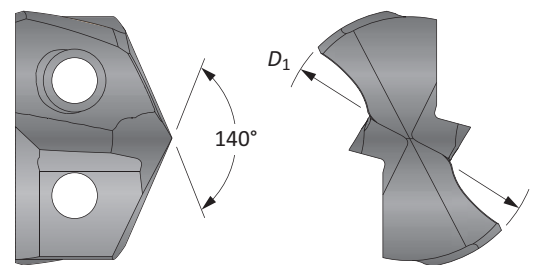

Regrinding and Recoating

The GEN3SYS XT and XT Pro drilling system is so cost efficient that it eliminates the need for regrinding and recoating. However, if you choose to have your drill inserts reground, it is critical that it be done by Allied Machine. Any slight deviation in performance due to an improperly reground drill insert will more than offset any benefit from regrinding. Using our service ensures that the best tool performance is maintained in your production process. When returning tools for regrinding, please package tools carefully to avoid damage during shipment. Returning drill inserts for regrinding in their original packaging will help avoid damage during shipment. Drill inserts reground by Allied Machine are repackaged and clearly identified as "Allied Regrind" to avoid any confusion with new tools.

Reference Key

Symbol	Attribute
D_1	Insert diameter

Product Nomenclature

GEN3SYS and XT Pro Drill Holders

HXT	03	12	S	-	20	FM
1	2	3	4		5	6



1. Holder	2. Length	3. Series	4. Flute												
<p>6 = GEN3SYS holder</p> <p>HXT = XT Pro holder</p>	<p>01 = Stub Length (GEN3SYS only)</p> <p>03 = 3x Diameter</p> <p>05 = 5x Diameter</p> <p>07 = 7x Diameter</p> <p>10 = 10x Diameter (XT Pro only)</p> <p>12 = 12x Diameter (11-26 series - XT Pro only)</p>	<p>11 = 11 series 18 = 18 series</p> <p>12 = 12 series 20 = 20 series</p> <p>13 = 13 series 22 = 22 series</p> <p>14 = 14 series 24 = 24 series</p> <p>15 = 15 series 26 = 26 series</p> <p>16 = 16 series 29 = 29 series</p> <p>17 = 17 series 32 = 32 series</p>	<p>S = Straight</p> <p>H = Helical</p> <p>C45 = Drill/Chamfer (both helical and drill/chamfer options available for GEN3SYS only)</p>												
5. Shank Diameter	6. Shank Style														
<table border="1"> <thead> <tr> <th>Imperial (inch)</th> <th>Metric (mm)</th> </tr> </thead> <tbody> <tr> <td>063 = 5/8"</td> <td>16 = 16 mm</td> </tr> <tr> <td>075 = 3/4"</td> <td>20 = 20 mm</td> </tr> <tr> <td>100 = 1"</td> <td>25 = 25 mm</td> </tr> <tr> <td>125 = 1-1/4"</td> <td>32 = 32 mm</td> </tr> <tr> <td>150 = 1-1/2"</td> <td>40 = 40 mm</td> </tr> </tbody> </table>	Imperial (inch)	Metric (mm)	063 = 5/8"	16 = 16 mm	075 = 3/4"	20 = 20 mm	100 = 1"	25 = 25 mm	125 = 1-1/4"	32 = 32 mm	150 = 1-1/2"	40 = 40 mm	<p>F = Flanged with flat</p> <p>FM = Flanged metric with flat</p> <p>C = Cylindrical (no flat)</p> <p>CM = Cylindrical metric (no flat)</p>		
Imperial (inch)	Metric (mm)														
063 = 5/8"	16 = 16 mm														
075 = 3/4"	20 = 20 mm														
100 = 1"	25 = 25 mm														
125 = 1-1/4"	32 = 32 mm														
150 = 1-1/2"	40 = 40 mm														

Holder Ordering Information

The series designator (11 series, 12 series, etc.) in the top corner of each page is for your reference when ordering. Please refer to these series designators when placing an order. For example, a 12 series drill insert only fits into a 12 series holder.

Reference Key

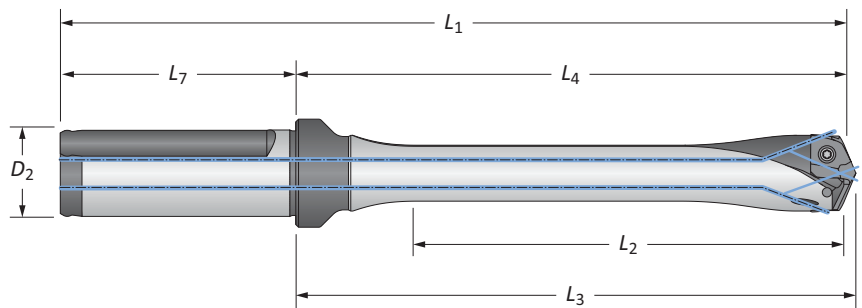

Symbol	Attribute
D_2	Shank diameter
D_5	Step diameter (drill/chamfer)
L_1	Overall length
L_2	Drill depth
L_3	Holder reference length
L_4	Holder body length
L_5	Step length (drill/chamfer)
L_7	Shank length
P_1	Rear pipe tap (GEN3SYS)

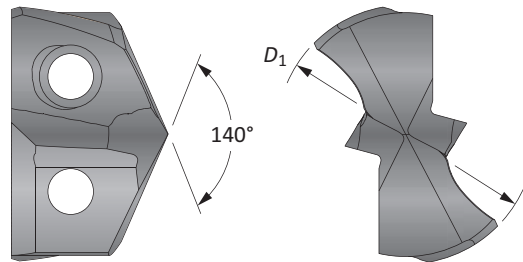
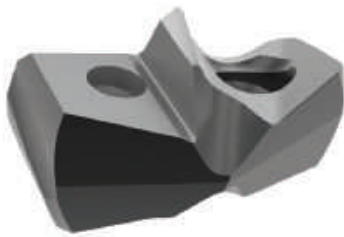

GEN3SYS XT Pro Drill Inserts

11 Series | Diameter Range: 0.4331" - 0.4723" (11.00 mm - 11.99 mm)



Fractional Equivalent	Insert				
	D_1 inch	D_1 mm	Part No. P	Part No. K	Part No. N
-	0.4331	11.00	XTP11-11.00	XTK11-11.00	XTN11-11.00
7/16	0.4374	11.11	XTP11-11.11	XTK11-11.11	XTN11-11.11
-	0.4409	11.20	XTP11-11.20	XTK11-11.20	XTN11-11.20
-	0.4449	11.30	XTP11-11.30	XTK11-11.30	XTN11-11.30
-	0.4488	11.40	XTP11-11.40	XTK11-11.40	XTN11-11.40
-	0.4528	11.50	XTP11-11.50	XTK11-11.50	XTN11-11.50
29/64	0.4531	11.51	XTP11-11.51	XTK11-11.51	XTN11-11.51
-	0.4567	11.60	XTP11-11.60	XTK11-11.60	XTN11-11.60
-	0.4606	11.70	XTP11-11.70	XTK11-11.70	XTN11-11.70
-	0.4646	11.80	XTP11-11.80	XTK11-11.80	XTN11-11.80
15/32	0.4689	11.91	XTP11-11.91	XTK11-11.91	XTN11-11.91

Inserts sold in multiples of 1

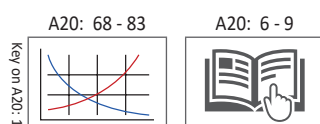

Sizes not shown are available upon request. When ordering, please follow the example below:	
Imperial:	0.5180", Steel, 13 series = use Part No. XTP13-13.16
Metric:	13.16 mm, Steel, 13 series = use Part No. XTP13-13.16



GEN3SYS XT Pro Drill Insert Holders

11 Series | Diameter Range: 0.4331" - 0.4723" (11.00 mm - 11.99 mm)

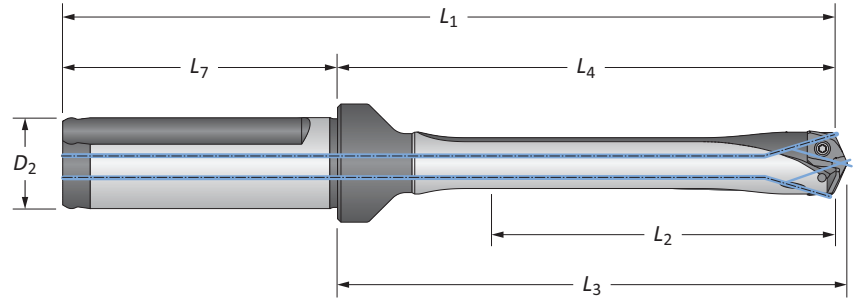

Flute	Body					Shank			Part No.
	Length	L ₂	L ₄	L ₃	L ₁	L ₇	D ₂	Flat	
i Straight 	3xD	1-27/64	2-29/64	2-17/32	4-21/64	1-7/8	5/8	YES	HXT0311S-063F
	3xD	1-27/64	2-29/64	2-17/32	4-21/64	1-7/8	5/8	NO	HXT0311S-063C
	5xD	2-23/64	3-13/32	3-31/64	5-9/32	1-7/8	5/8	YES	HXT0511S-063F
	5xD	2-23/64	3-13/32	3-31/64	5-9/32	1-7/8	5/8	NO	HXT0511S-063C
	7xD	3-19/64	4-11/32	4-27/64	6-7/32	1-7/8	5/8	YES	HXT0711S-063F
	7xD	3-19/64	4-11/32	4-27/64	6-7/32	1-7/8	5/8	NO	HXT0711S-063C
	10xD	4-23/32	5-49/64	5-27/32	7-41/64	1-7/8	5/8	YES	HXT1011S-063F
	10xD	4-23/32	5-49/64	5-27/32	7-41/64	1-7/8	5/8	NO	HXT1011S-063C
m Straight 	3xD	36.0	62.6	64.4	110.6	48.0	16.0	YES	HXT0311S-16FM
	3xD	36.0	62.6	64.4	110.6	48.0	16.0	NO	HXT0311S-16CM
	5xD	60.0	86.6	88.4	134.6	48.0	16.0	YES	HXT0511S-16FM
	5xD	60.0	86.6	88.4	134.6	48.0	16.0	NO	HXT0511S-16CM
	7xD	83.7	110.6	112.4	158.6	48.0	16.0	YES	HXT0711S-16FM
	7xD	83.7	110.6	112.4	158.6	48.0	16.0	NO	HXT0711S-16CM
	10xD	119.9	146.6	148.4	194.6	48.0	16.0	YES	HXT1011S-16FM
	10xD	119.9	146.6	148.4	194.6	48.0	16.0	NO	HXT1011S-16CM
12xD	119.9	146.6	148.4	194.6	48.0	16.0	YES	HXT1211S-16FM	
12xD	119.9	146.6	148.4	194.6	48.0	16.0	NO	HXT1211S-16CM	

Connection Accessories

				Admissible Tightening Torque*
Insert Screws 71843-IP6-1	Insert Driver 8IP-6	Preset Torque Hand Driver 8IP-6TL	Replacement Tips 8IP-6B	4.4 in-lbs (50 N-cm)

*Tightening torques are calculated with a friction coefficient of $\mu = 0.14$ and develop 90% of ultimate yield strength

WARNING Refer to Speed and Feed charts for recommended adjustments to speeds and feeds. Refer to page A20: 86 for deep hole drilling guidelines in this section of the catalog. Visit www.alliedmachine.com/DeepHoleGuidelines for the most up-to-date information and procedures. Factory technical assistance is available for your specific applications through our Application Engineering Team. ext: 7611 | email: appeng@alliedmachine.com

i = Imperial (in)
m = Metric (mm)





Screws sold in multiples of 10

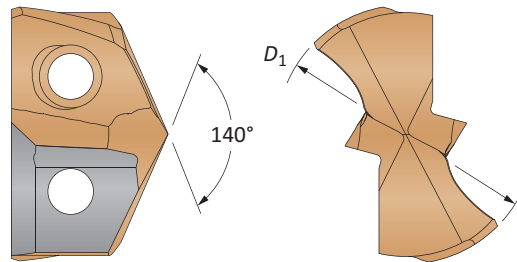
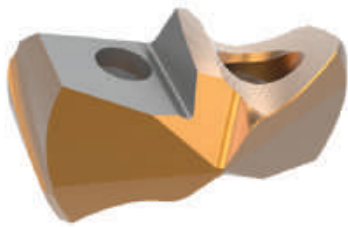

GEN3SYS XT Drill Inserts

11 Series | Diameter Range: 0.4331" - 0.4723" (11.00 mm - 11.99 mm)



Carbide Substrate	Insert			 Standard Part No.	 Low Rake Part No.	 Cast Iron Part No.	 Stainless Part No.
	Fractional Equivalent	D_1 inch	D_1 mm				
C1 (K35)	-	0.4331	11.00	7C111P-11	7C111P-11LR	-	-
	7/16	0.4375	11.11	7C111P-0014	7C111P-0014LR	-	-
	-	0.4528	11.50	7C111P-11.5	7C111P-11.5LR	-	-
	29/64	0.4531	11.51	7C111P-.453	7C111P-.453LR	-	-
	15/32	0.4688	11.91	7C111P-0015	7C111P-0015LR	-	-
C2 (K20)	-	0.4331	11.00	7C211P-11	7C211P-11LR	7C211P-11CI	7C211P-11AS
	7/16	0.4375	11.11	7C211P-0014	7C211P-0014LR	7C211P-0014CI	7C211P-0014AS
	-	0.4528	11.50	7C211P-11.5	7C211P-11.5LR	7C211P-11.5CI	7C211P-11.5AS
	29/64	0.4531	11.51	7C211P-.453	7C211P-.453LR	7C211P-.453CI	7C211P-.453AS
	15/32	0.4688	11.91	7C211P-0015	7C211P-0015LR	7C211P-0015CI	7C211P-0015AS

Inserts sold in multiples of 1

A20: 68 - 83

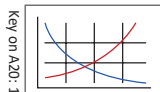

A20: 6 - 9



Sizes not shown are available upon request.

When ordering, please follow the example below:

Imperial:	0.5200", 13 series, C2 = use Part No. 7C213P-.5200
Metric:	13.20 mm, 13 series, C2 = use Part No. 7C213P-13.20

GEN3SYS Drill Insert Holders

11 Series | Diameter Range: 0.4331" - 0.4723" (11.00 mm - 11.99 mm)

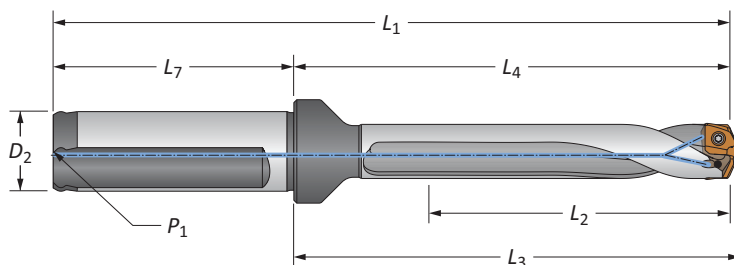

Straight and Helical

Flute	Length	Body				Shank				Flat	Part No.
		L ₂	L ₄	L ₃	L ₁	L ₇	D ₂	P ₁			
	3xD	1-27/64	2-29/64	2-17/32	4-21/64	1-7/8	5/8	1/16	YES	60311S-063F	
	5xD	2-23/64	3-13/32	3-31/64	5-9/32	1-7/8	5/8	1/16	YES	60511S-063F	
	7xD	3-19/64	4-11/32	4-27/64	6-7/32	1-7/8	5/8	1/16	YES	60711S-063F	
	Stub	5/8	1-43/64	1-3/4	3-35/64	1-7/8	5/8	1/16	YES	60111H-063F	
	3xD	1-27/64	2-29/64	2-17/32	4-21/64	1-7/8	5/8	1/16	YES	60311H-063F	
	3xD	1-27/64	2-29/64	2-17/32	4-21/64	1-7/8	5/8	1/16	NO	60311H-063C	
	5xD	2-23/64	3-13/32	3-31/64	5-9/32	1-7/8	5/8	1/16	YES	60511H-063F	
	5xD	2-23/64	3-13/32	3-31/64	5-9/32	1-7/8	5/8	1/16	NO	60511H-063C	
	7xD	3-19/64	4-11/32	4-27/64	6-7/32	1-7/8	5/8	1/16	YES	60711H-063F	
	7xD	3-19/64	4-11/32	4-27/64	6-7/32	1-7/8	5/8	1/16	NO	60711H-063C	
	Straight	3xD	36.0	62.6	64.4	110.6	48.0	16.0	1/16*	YES	60311S-16FM
		5xD	60.0	86.6	88.4	134.6	48.0	16.0	1/16*	YES	60511S-16FM
		7xD	83.7	110.6	112.4	158.6	48.0	16.0	1/16*	YES	60711S-16FM
	Helical	Stub	16.0	42.6	44.7	90.6	48.0	16.0	1/16*	YES	60111H-16FM
		3xD	36.0	62.6	64.4	110.6	48.0	16.0	1/16*	YES	60311H-16FM
		3xD	36.0	62.6	64.4	110.6	48.0	16.0	1/16*	NO	60311H-16CM
		5xD	60.0	86.6	88.4	134.6	48.0	16.0	1/16*	YES	60511H-16FM
		5xD	60.0	86.6	88.4	134.6	48.0	16.0	1/16*	NO	60511H-16CM
		7xD	83.7	110.6	112.4	158.6	48.0	16.0	1/16*	YES	60711H-16FM
		7xD	83.7	110.6	112.4	158.6	48.0	16.0	1/16*	NO	60711H-16CM

*Thread to BSP and ISO 7-1

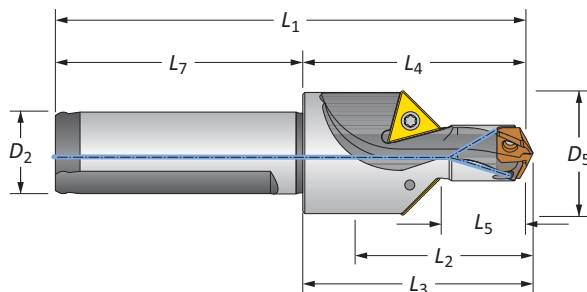

Drill / Chamfer

	Step		Body				Shank		Part No.	Chamfer Insert
	D ₅	L ₅	L ₂	L ₄	L ₃	L ₁	L ₇	D ₂		
	61/64	21/32	15/16	1-43/64	1-3/4	3-35/64	1-7/8	5/8	60111C45-063F	TCMT-110204
	24.1	16.5	23.8	42.2	44.3	90.2	48.0	16.0	60111C45-16FM	TCMT-110204

Connection Accessories

				Admissible Tightening Torque*
Insert Screws	Insert Driver	Preset Torque Hand Driver	Replacement Tips	
71843-IP6-1	8IP-6	8IP-6TL	8IP-6B	4.4 in-lbs (50 N-cm)

*Tightening torques are calculated with a friction coefficient of $\mu = 0.14$ and develop 90% of ultimate yield strength



Chamfer inserts sold separately in multiples of 10 | Screws sold in multiples of 10

= Imperial (in)
 = Metric (mm)

GEN3SYS XT Pro Drill Inserts

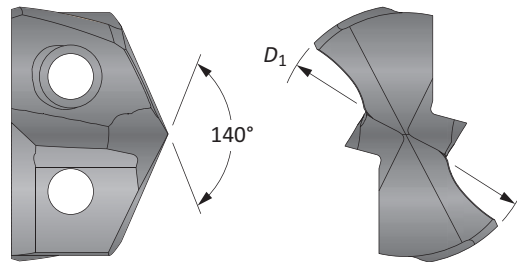
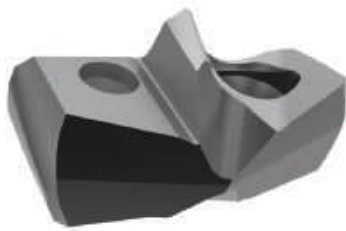
12 Series | Diameter Range: 0.4724" - 0.5117" (12.00 mm - 12.99 mm)



Fractional Equivalent	Insert				
	D_1 inch	D_1 mm	Part No. P	Part No. K	Part No. N
-	0.4724	12.00	XTP12-12.00	XTK12-12.00	XTN12-12.00
-	0.4764	12.10	XTP12-12.10	XTK12-12.10	XTN12-12.10
-	0.4803	12.20	XTP12-12.20	XTK12-12.20	XTN12-12.20
31/64	0.4843	12.30	XTP12-12.30	XTK12-12.30	XTN12-12.30
-	0.4882	12.40	XTP12-12.40	XTK12-12.40	XTN12-12.40
-	0.4921	12.50	XTP12-12.50	XTK12-12.50	XTN12-12.50
-	0.4961	12.60	XTP12-12.60	XTK12-12.60	XTN12-12.60
1/2	0.5000	12.70	XTP12-12.70	XTK12-12.70	XTN12-12.70
-	0.5039	12.80	XTP12-12.80	XTK12-12.80	XTN12-12.80
-	0.5079	12.90	XTP12-12.90	XTK12-12.90	XTN12-12.90

Inserts sold in multiples of 1

A20: 68 - 83

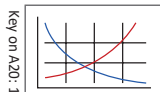

Key on A20: 1

A20: 6 - 9



Sizes not shown are available upon request.
When ordering, please follow the example below:

Imperial:	0.5180", Steel, 13 series = use Part No. XTP13-13.16
Metric:	13.16 mm, Steel, 13 series = use Part No. XTP13-13.16

GEN3SYS XT Pro Drill Insert Holders

12 Series | Diameter Range: 0.4724" - 0.5117" (12.00 mm - 12.99 mm)

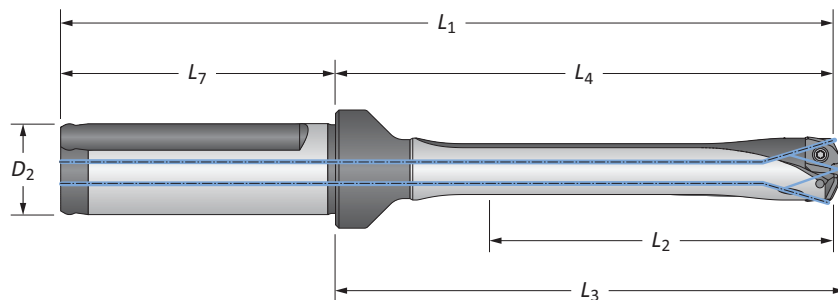

Flute	Body					Shank			Part No.
	Length	L ₂	L ₄	L ₃	L ₁	L ₇	D ₂	Flat	
i Straight 	3xD	1-17/32	2-5/8	2-45/64	4-21/32	2-1/32	3/4	YES	HXT0312S-075F
	3xD	1-17/32	2-5/8	2-45/64	4-21/32	2-1/32	3/4	NO	HXT0312S-075C
	5xD	2-9/16	3-41/64	3-47/64	5-43/64	2-1/32	3/4	YES	HXT0512S-075F
	5xD	2-9/16	3-41/64	3-47/64	5-43/64	2-1/32	3/4	NO	HXT0512S-075C
	7xD	3-37/64	4-21/32	4-3/4	6-11/16	2-1/32	3/4	YES	HXT0712S-075F
	7xD	3-37/64	4-21/32	4-3/4	6-11/16	2-1/32	3/4	NO	HXT0712S-075C
	10xD	5-7/64	6-13/64	6-9/32	8-15/64	2-1/32	3/4	YES	HXT1012S-075F
	10xD	5-7/64	6-13/64	6-9/32	8-15/64	2-1/32	3/4	NO	HXT1012S-075C
	12xD	6-9/64	7-7/32	7-5/16	9-1/4	2-1/32	3/4	YES	HXT1212S-075F
12xD	6-9/64	7-7/32	7-5/16	9-1/4	2-1/32	3/4	NO	HXT1212S-075C	
m Straight 	3xD	39.0	66.6	68.7	116.6	50.0	20.0	YES	HXT0312S-20FM
	3xD	39.0	66.6	68.7	116.6	50.0	20.0	NO	HXT0312S-20CM
	5xD	65.0	92.5	94.7	142.5	50.0	20.0	YES	HXT0512S-20FM
	5xD	65.0	92.5	94.7	142.5	50.0	20.0	NO	HXT0512S-20CM
	7xD	90.9	118.3	120.7	168.3	50.0	20.0	YES	HXT0712S-20FM
	7xD	90.9	118.3	120.7	168.3	50.0	20.0	NO	HXT0712S-20CM
	10xD	129.9	157.5	159.7	207.5	50.0	20.0	YES	HXT1012S-20FM
	10xD	129.9	157.5	159.7	207.5	50.0	20.0	NO	HXT1012S-20CM
	12xD	156.0	183.5	185.7	233.5	50.0	20.0	YES	HXT1212S-20FM
12xD	156.0	183.5	185.7	233.5	50.0	20.0	NO	HXT1212S-20CM	

Connection Accessories

					Admissible Tightening Torque*
7247-IP7-1	7247N-IP7-1	8IP-7	8IP-7TL	8IP-7B	7.4 in-lbs (84 N-cm)

*Tightening torques are calculated with a friction coefficient of $\mu = 0.14$ and develop 90% of ultimate yield strength

⚠ WARNING Refer to Speed and Feed charts for recommended adjustments to speeds and feeds. Refer to page A20: 86 for deep hole drilling guidelines in this section of the catalog. Visit www.alliedmachine.com/DeepHoleGuidelines for the most up-to-date information and procedures. Factory technical assistance is available for your specific applications through our Application Engineering Team. ext: 7611 | email: appeng@alliedmachine.com

i = Imperial (in)
m = Metric (mm)

Screws sold in multiples of 10



GEN3SYS XT Drill Inserts

12 Series | Diameter Range: 0.4724" - 0.5117" (12.00 mm - 12.99 mm)

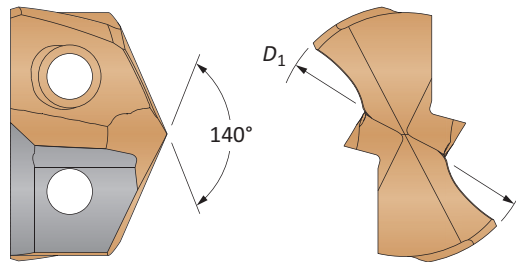
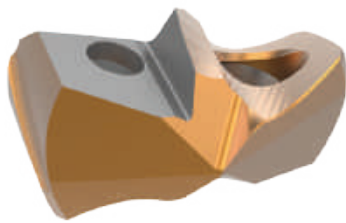

Carbide Substrate	Insert			Standard Part No.	Low Rake Part No.	Cast Iron Part No.	Stainless Part No.
	Fractional Equivalent	D_1 inch	D_1 mm				
C1 (K35)	-	0.4724	12.00	7C112P-12	7C112P-12LR	-	-
	31/64	0.4844	12.30	7C112P-.484	7C112P-.484LR	-	-
	-	0.4921	12.50	7C112P-12.5	7C112P-12.5LR	-	-
	1/2	0.5000	12.70	7C112P-0016	7C112P-0016LR	-	-
C2 (K20)	-	0.4724	12.00	7C212P-12	7C212P-12LR	7C212P-12CI	7C212P-12AS
	31/64	0.4844	12.30	7C212P-.484	7C212P-.484LR	7C212P-.484CI	7C212P-.484AS
	-	0.4921	12.50	7C212P-12.5	7C212P-12.5LR	7C212P-12.5CI	7C212P-12.5AS
	1/2	0.5000	12.70	7C212P-0016	7C212P-0016LR	7C212P-0016CI	7C212P-0016AS

Inserts sold in multiples of 1

A20: 68 - 83

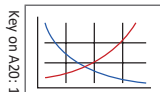

A20: 6 - 9



Sizes not shown are available upon request.
When ordering, please follow the example below:

Imperial:	0.5200", 13 series, C2 = use Part No. 7C213P-.5200
Metric:	13.20 mm, 13 series, C2 = use Part No. 7C213P-13.20

GEN3SYS Drill Insert Holders

12 Series | Diameter Range: 0.4724" - 0.5117" (12.00 mm - 12.99 mm)

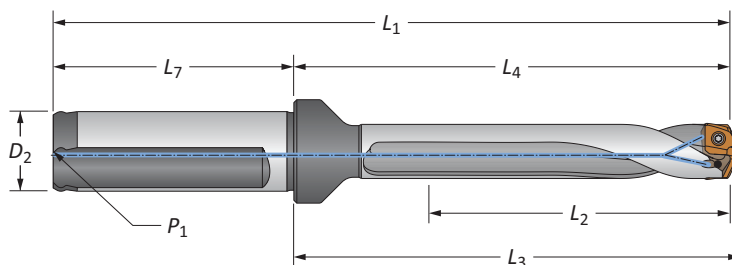

Straight and Helical

Flute	Length	Body				Shank				Flat	Part No.
		L ₂	L ₄	L ₃	L ₁	L ₇	D ₂	P ₁			
	3xD	1-17/32	2-5/8	2-45/64	4-21/32	2-1/32	3/4	1/8	YES	60312S-075F	
	5xD	2-9/16	3-41/64	3-47/64	5-43/64	2-1/32	3/4	1/8	YES	60512S-075F	
	7xD	3-37/64	4-21/32	4-3/4	6-11/16	2-1/32	3/4	1/8	YES	60712S-075F	
	Stub	5/8	1-45/64	1-25/32	3-47/64	2-1/32	3/4	1/8	YES	60112H-075F	
	3xD	1-17/32	2-5/8	2-45/64	4-21/32	2-1/32	3/4	1/8	YES	60312H-075F	
	3xD	1-17/32	2-5/8	2-45/64	4-21/32	2-1/32	3/4	1/8	NO	60312H-075C	
	5xD	2-9/16	3-41/64	3-47/64	5-43/64	2-1/32	3/4	1/8	YES	60512H-075F	
	5xD	2-9/16	3-41/64	3-47/64	5-43/64	2-1/32	3/4	1/8	NO	60512H-075C	
	7xD	3-37/64	4-21/32	4-3/4	6-11/16	2-1/32	3/4	1/8	YES	60712H-075F	
	7xD	3-37/64	4-21/32	4-3/4	6-11/16	2-1/32	3/4	1/8	NO	60712H-075C	
		3xD	39.0	66.6	68.7	116.6	50.0	20.0	1/8*	YES	60312S-20FM
5xD		65.0	92.5	94.7	142.5	50.0	20.0	1/8*	YES	60512S-20FM	
7xD		90.9	118.3	120.7	168.3	50.0	20.0	1/8*	YES	60712S-20FM	
Stub		16.0	43.2	45.4	93.2	50.0	20.0	1/8*	YES	60112H-20FM	
3xD		39.0	66.6	68.7	116.6	50.0	20.0	1/8*	YES	60312H-20FM	
3xD		39.0	66.6	68.7	116.6	50.0	20.0	1/8*	NO	60312H-20CM	
5xD		65.0	92.5	94.7	142.5	50.0	20.0	1/8*	YES	60512H-20FM	
5xD		65.0	92.5	94.7	142.5	50.0	20.0	1/8*	NO	60512H-20CM	
7xD		90.9	118.3	120.7	168.3	50.0	20.0	1/8*	YES	60712H-20FM	
7xD		90.9	118.3	120.7	168.3	50.0	20.0	1/8*	NO	60712H-20CM	

*Thread to BSP and ISO 7-1

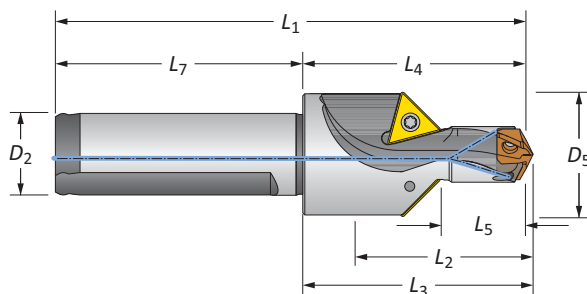

Drill / Chamfer

	Step		Body				Shank		Part No.	Chamfer Insert
	D ₅	L ₅	L ₂	L ₄	L ₃	L ₁	L ₇	D ₂		
i	31/32	45/64	63/64	1-45/64	1-25/32	3-47/64	2-1/32	3/4	60112C45-075F	TCMT-110204
m	24.8	18.0	35.2	43.2	45.4	93.2	50.0	20.0	60112C45-20FM	TCMT-110204

Connection Accessories

Insert Screws	Nylon Locking Screws	Insert Driver	Preset Torque Hand Driver	Replacement Tips	Admissible Tightening Torque*
7247-IP7-1	7247N-IP7-1	8IP-7	8IP-7TL	8IP-7B	7.4 in-lbs (84 N-cm)

*Tightening torques are calculated with a friction coefficient of $\mu = 0.14$ and develop 90% of ultimate yield strength



Chamfer inserts sold separately in multiples of 10 | Screws sold in multiples of 10

i = Imperial (in)
m = Metric (mm)

GEN3SYS XT Pro Drill Inserts

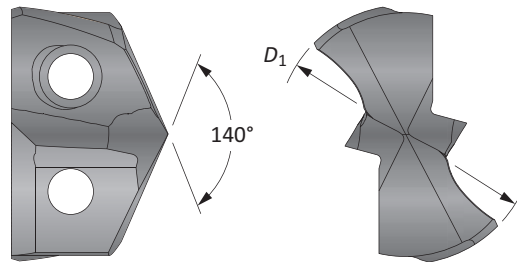
13 Series | Diameter Range: 0.5118" - 0.5511" (13.00 mm - 13.99 mm)



Fractional Equivalent	Insert				
	D_1 inch	D_1 mm	Part No. P	Part No. K	Part No. N
-	0.5118	13.00	XTP13-13.00	XTK13-13.00	XTN13-13.00
33/64	0.5157	13.10	XTP13-13.10	XTK13-13.10	XTN13-13.10
-	0.5197	13.20	XTP13-13.20	XTK13-13.20	XTN13-13.20
-	0.5236	13.30	XTP13-13.30	XTK13-13.30	XTN13-13.30
-	0.5276	13.40	XTP13-13.40	XTK13-13.40	XTN13-13.40
17/32	0.5311	13.49	XTP13-13.49	XTK13-13.49	XTN13-13.49
-	0.5315	13.50	XTP13-13.50	XTK13-13.50	XTN13-13.50
-	0.5354	13.60	XTP13-13.60	XTK13-13.60	XTN13-13.60
-	0.5394	13.70	XTP13-13.70	XTK13-13.70	XTN13-13.70
-	0.5433	13.80	XTP13-13.80	XTK13-13.80	XTN13-13.80
35/64	0.5469	13.89	XTP13-13.89	XTK13-13.89	XTN13-13.89

Inserts sold in multiples of 1

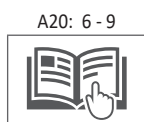
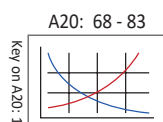

Sizes not shown are available upon request. When ordering, please follow the example below:	
Imperial:	0.5180", Steel, 13 series = use Part No. XTP13-13.16
Metric:	13.16 mm, Steel, 13 series = use Part No. XTP13-13.16

GEN3SYS XT Pro Drill Insert Holders

13 Series | Diameter Range: 0.5118" - 0.5511" (13.00 mm - 13.99 mm)

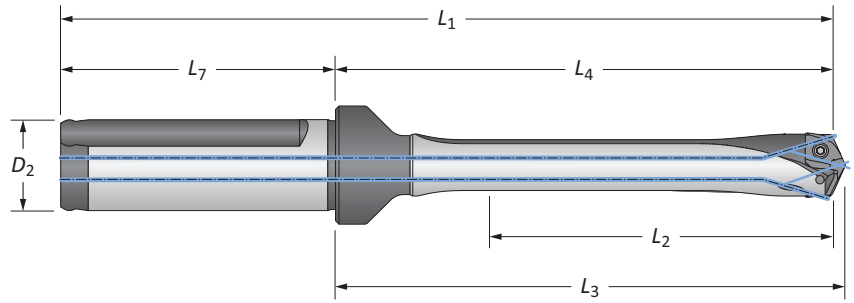

Flute	Body					Shank			Part No.
	Length	L ₂	L ₄	L ₃	L ₁	L ₇	D ₂	Flat	
i Straight 	3xD	1-21/32	2-23/32	2-13/16	4-3/4	2-1/32	3/4	YES	HXT0313S-075F
	3xD	1-21/32	2-23/32	2-13/16	4-3/4	2-1/32	3/4	NO	HXT0313S-075C
	5xD	2-3/4	3-13/16	3-29/32	5-27/32	2-1/32	3/4	YES	HXT0513S-075F
	5xD	2-3/4	3-13/16	3-29/32	5-27/32	2-1/32	3/4	NO	HXT0513S-075C
	7xD	3-55/64	4-59/64	5-1/64	6-61/64	2-1/32	3/4	YES	HXT0713S-075F
	7xD	3-55/64	4-59/64	5-1/64	6-61/64	2-1/32	3/4	NO	HXT0713S-075C
	10xD	5-33/64	6-37/64	6-43/64	8-39/64	2-1/32	3/4	YES	⚠ HXT1013S-075F
	10xD	5-33/64	6-37/64	6-43/64	8-39/64	2-1/32	3/4	NO	⚠ HXT1013S-075C
	12xD	6-39/64	7-11/16	7-25/32	9-23/32	2-1/32	3/4	YES	⚠ HXT1213S-075F
12xD	6-39/64	7-11/17	7-25/32	9-23/32	2-1/32	3/4	NO	⚠ HXT1213S-075C	
m Straight 	3xD	42.0	69.0	71.4	119.0	50.0	20.0	YES	HXT0313S-20FM
	3xD	42.0	69.0	71.4	119.0	50.0	20.0	NO	HXT0313S-20CM
	5xD	69.9	96.8	99.2	146.8	50.0	20.0	YES	HXT0513S-20FM
	5xD	69.9	96.8	99.2	146.8	50.0	20.0	NO	HXT0513S-20CM
	7xD	98.0	125.0	127.4	175.0	50.0	20.0	YES	HXT0713S-20FM
	7xD	98.0	125.0	127.4	175.0	50.0	20.0	NO	HXT0713S-20CM
	10xD	140.0	167.0	169.4	217.0	50.0	20.0	YES	⚠ HXT1013S-20FM
	10xD	140.0	167.0	169.4	217.0	50.0	20.0	NO	⚠ HXT1013S-20CM
	12xD	168.0	195.2	197.4	245.2	50.0	20.0	YES	⚠ HXT1213S-20FM
12xD	168.0	195.2	197.4	245.2	50.0	20.0	NO	⚠ HXT1213S-20CM	

Connection Accessories

					Admissible Tightening Torque*
7247-IP7-1	7247N-IP7-1	8IP-7	8IP-7TL	8IP-7B	

*Tightening torques are calculated with a friction coefficient of $\mu = 0.14$ and develop 90% of ultimate yield strength

⚠ WARNING Refer to Speed and Feed charts for recommended adjustments to speeds and feeds. Refer to page A20: 86 for deep hole drilling guidelines in this section of the catalog. Visit www.alliedmachine.com/DeepHoleGuidelines for the most up-to-date information and procedures. Factory technical assistance is available for your specific applications through our Application Engineering Team. ext: 7611 | email: appeng@alliedmachine.com

i = Imperial (in)
m = Metric (mm)

Screws sold in multiples of 10

A DRILLING
B BORING
C REAMING
D BURNISHING
E THREADING
X SPECIALS



GEN3SYS XT Drill Inserts

13 Series | Diameter Range: 0.5118" - 0.5511" (13.00 mm - 13.99 mm)

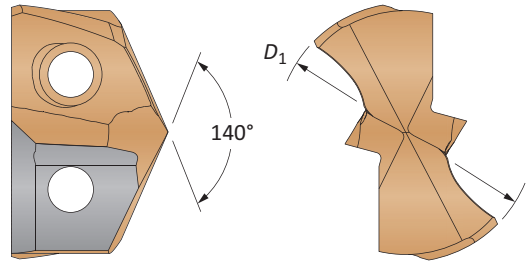
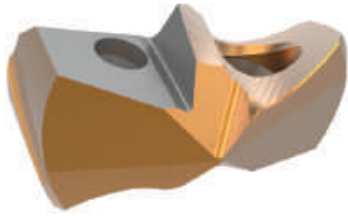

Carbide Substrate	Insert			Standard Part No.	Low Rake Part No.	Cast Iron Part No.	Stainless Part No.
	Fractional Equivalent	D ₁ inch	D ₁ mm				
C1 (K35)	-	0.5118	13.00	7C113P-13	7C113P-13LR	-	-
	33/64	0.5156	13.08	7C113P-.515	7C113P-.515LR	-	-
	17/32	0.5313	13.49	7C113P-0017	7C113P-0017LR	-	-
	-	0.5315	13.50	7C113P-13.5	7C113P-13.5LR	-	-
	35/64	0.5469	13.89	7C113P-.546	7C113P-.546LR	-	-
C2 (K20)	-	0.5118	13.00	7C213P-13	7C213P-13LR	7C213P-13CI	7C213P-13AS
	33/64	0.5156	13.08	7C213P-.515	7C213P-.515LR	7C213P-.515CI	7C213P-.515AS
	17/32	0.5312	13.49	7C213P-0017	7C213P-0017LR	7C213P-0017CI	7C213P-0017AS
	-	0.5315	13.50	7C213P-13.5	7C213P-13.5LR	7C213P-13.5CI	7C213P-13.5AS
	35/64	0.5469	13.89	7C213P-.546	7C213P-.546LR	7C213P-.546CI	7C213P-.546AS

Inserts sold in multiples of 1

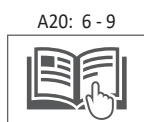
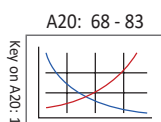

Sizes not shown are available upon request. When ordering, please follow the example below:	
Imperial:	0.5200", 13 series, C2 = use Part No. 7C213P-.5200
Metric:	13.20 mm, 13 series, C2 = use Part No. 7C213P-13.20

GEN3SYS Drill Insert Holders

13 Series | Diameter Range: 0.5118" - 0.5511" (13.00 mm - 13.99 mm)

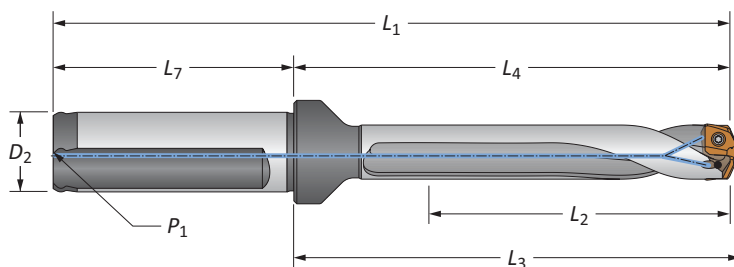

Straight and Helical

Flute	Length	Body				Shank				Flat	Part No.
		L ₂	L ₄	L ₃	L ₁	L ₇	D ₂	P ₁			
	3xD	1-21/32	2-23/32	2-13/16	4-3/4	2-1/32	3/4	1/8	YES	60313S-075F	
	5xD	2-3/4	3-13/16	3-29/32	5-27/32	2-1/32	3/4	1/8	YES	60513S-075F	
	7xD	3-55/64	4-59/64	5-1/64	6-61/64	2-1/32	3/4	1/8	YES	60713S-075F	
	Stub	5/8	1-11/16	1-25/32	3-23/32	2-1/32	3/4	1/8	YES	60113H-075F	
	3xD	1-21/32	2-23/32	2-13/16	4-3/4	2-1/32	3/4	1/8	YES	60313H-075F	
	3xD	1-21/32	2-23/32	2-13/16	4-3/4	2-1/32	3/4	1/8	NO	60313H-075C	
	5xD	2-3/4	3-13/16	3-29/32	5-27/32	2-1/32	3/4	1/8	YES	60513H-075F	
	5xD	2-3/4	3-13/16	3-29/32	5-27/32	2-1/32	3/4	1/8	NO	60513H-075C	
	7xD	3-55/64	4-59/64	5-1/64	6-61/64	2-1/32	3/4	1/8	YES	60713H-075F	
	7xD	3-55/64	4-59/64	5-1/64	6-61/64	2-1/32	3/4	1/8	NO	60713H-075C	
	Straight	3xD	42.0	69.0	71.4	119.0	50.0	20.0	1/8*	YES	60313S-20FM
		5xD	69.9	96.8	99.2	146.8	50.0	20.0	1/8*	YES	60513S-20FM
		7xD	98.0	125.0	127.4	175.0	50.0	20.0	1/8*	YES	60713S-20FM
	Helical	Stub	16.0	43.0	45.2	93.0	50.0	20.0	1/8*	YES	60113H-20FM
		3xD	42.0	69.0	71.4	119.0	50.0	20.0	1/8*	YES	60313H-20FM
		3xD	42.0	69.0	71.4	119.0	50.0	20.0	1/8*	NO	60313H-20CM
		5xD	69.9	96.8	99.2	146.8	50.0	20.0	1/8*	YES	60513H-20FM
		5xD	69.9	96.8	99.2	146.8	50.0	20.0	1/8*	NO	60513H-20CM
		7xD	98.0	125.0	127.4	175.0	50.0	20.0	1/8*	YES	60713H-20FM
		7xD	98.0	125.0	127.4	175.0	50.0	20.0	1/8*	NO	60713H-20CM

*Thread to BSP and ISO 7-1

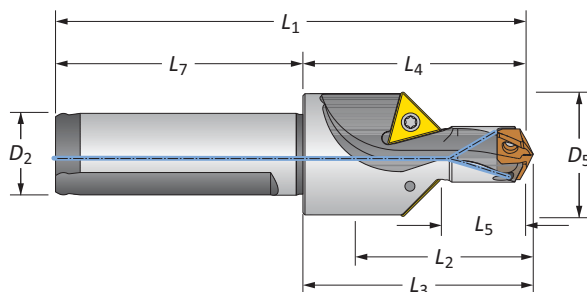

Drill / Chamfer

	Step		Body				Shank		Part No.	Chamfer Insert
	D ₅	L ₅	L ₂	L ₄	L ₃	L ₁	L ₇	D ₂		
	1-1/64	49/64	1	1-11/16	1-25/32	3-23/32	2-1/32	3/4	60113C45-075F	TCMT-110204
	25.8	19.5	25.4	43.0	45.2	93.0	50.0	20.0	60113C45-20FM	TCMT-110204

Connection Accessories

					Admissible Tightening Torque*
7247-IP7-1	7247N-IP7-1	8IP-7	8IP-7TL	8IP-7B	

*Tightening torques are calculated with a friction coefficient of $\mu = 0.14$ and develop 90% of ultimate yield strength



Chamfer inserts sold separately in multiples of 10 | Screws sold in multiples of 10

= Imperial (in)
 = Metric (mm)

GEN3SYS XT Pro Drill Inserts

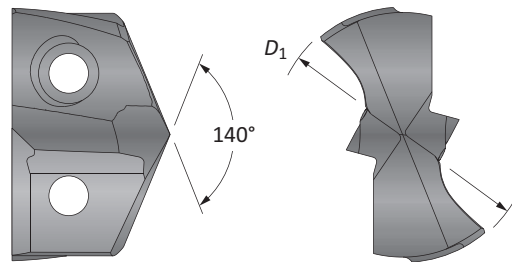
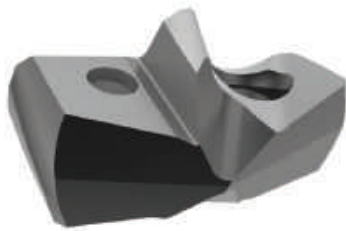
14 Series | Diameter Range: 0.5512" - 0.5905" (14.00 mm - 14.99 mm)



Fractional Equivalent	Insert				
	D_1 inch	D_1 mm	Part No. P	Part No. K	Part No. N
-	0.5512	14.00	XTP14-14.00	XTK14-14.00	XTN14-14.00
-	0.5551	14.10	XTP14-14.10	XTK14-14.10	XTN14-14.10
-	0.5591	14.20	XTP14-14.20	XTK14-14.20	XTN14-14.20
9/16	0.5626	14.29	XTP14-14.29	XTK14-14.29	XTN14-14.29
-	0.5669	14.40	XTP14-14.40	XTK14-14.40	XTN14-14.40
-	0.5709	14.50	XTP14-14.50	XTK14-14.50	XTN14-14.50
-	0.5748	14.60	XTP14-14.60	XTK14-14.60	XTN14-14.60
37/64	0.5780	14.68	XTP14-14.68	XTK14-14.68	XTN14-14.68
-	0.5827	14.80	XTP14-14.80	XTK14-14.80	XTN14-14.80
-	0.5866	14.90	XTP14-14.90	XTK14-14.90	XTN14-14.90

Inserts sold in multiples of 1

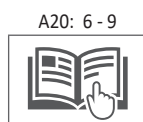
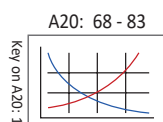

Sizes not shown are available upon request.	
When ordering, please follow the example below:	
Imperial:	0.5180", Steel, 13 series = use Part No. XTP13-13.16
Metric:	13.16 mm, Steel, 13 series = use Part No. XTP13-13.16

GEN3SYS XT Pro Drill Insert Holders

14 Series | Diameter Range: 0.5512" - 0.5905" (14.00 mm - 14.99 mm)

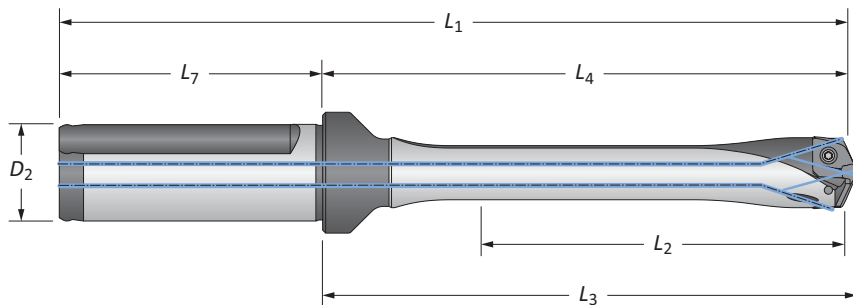

Flute	Body					Shank			Part No.
	Length	L ₂	L ₄	L ₃	L ₁	L ₇	D ₂	Flat	
i Straight	3xD	1-49/64	2-27/32	2-61/64	4-7/8	2-1/32	3/4	YES	HXT0314S-075F
	3xD	1-49/64	2-27/32	2-61/64	4-7/8	2-1/32	3/4	NO	HXT0314S-075C
	5xD	2-61/64	4-1/32	4-1/8	6-1/16	2-1/32	3/4	YES	HXT0514S-075F
	5xD	2-61/64	4-1/32	4-1/8	6-1/16	2-1/32	3/4	NO	HXT0514S-075C
	7xD	4-1/8	5-13/64	5-5/16	7-15/64	2-1/32	3/4	YES	HXT0714S-075F
	7xD	4-1/8	5-13/64	5-5/16	7-15/64	2-1/32	3/4	NO	HXT0714S-075C
	10xD	5-29/32	6-63/64	7-5/64	9-1/64	2-1/32	3/4	YES	HXT1014S-075F
	10xD	5-29/32	6-63/64	7-5/64	9-1/64	2-1/32	3/4	NO	HXT1014S-075C
m Straight	12xD	7-3/32	8-5/32	8-1/4	10-3/16	2-1/32	3/4	YES	HXT1214S-075F
	12xD	7-3/32	8-5/32	8-1/4	10-3/16	2-1/32	3/4	NO	HXT1214S-075C
	3xD	44.8	72.2	74.9	122.2	50.0	20.0	YES	HXT0314S-20FM
	3xD	44.8	72.2	74.9	122.2	50.0	20.0	NO	HXT0314S-20CM
	5xD	75.0	102.4	104.9	152.4	50.0	20.0	YES	HXT0514S-20FM
	5xD	75.0	102.4	104.9	152.4	50.0	20.0	NO	HXT0514S-20CM
	7xD	104.8	132.2	134.8	182.2	50.0	20.0	YES	HXT0714S-20FM
	7xD	104.8	132.2	134.8	182.2	50.0	20.0	NO	HXT0714S-20CM
	10xD	149.9	177.4	179.8	227.4	50.0	20.0	YES	HXT1014S-20FM
	10xD	149.9	177.4	179.8	227.4	50.0	20.0	NO	HXT1014S-20CM
	12xD	180.0	207.2	209.8	257.2	50.0	20.0	YES	HXT1214S-20FM
	12xD	180.0	207.2	209.8	257.2	50.0	20.0	NO	HXT1214S-20CM

Connection Accessories

					Admissible Tightening Torque*
7247-IP7-1	7247N-IP7-1	8IP-7	8IP-7TL	8IP-7B	
					7.4 in-lbs (84 N-cm)

*Tightening torques are calculated with a friction coefficient of $\mu = 0.14$ and develop 90% of ultimate yield strength

WARNING Refer to Speed and Feed charts for recommended adjustments to speeds and feeds. Refer to page A20: 86 for deep hole drilling guidelines in this section of the catalog. Visit www.alliedmachine.com/DeepHoleGuidelines for the most up-to-date information and procedures. Factory technical assistance is available for your specific applications through our Application Engineering Team. ext: 7611 | email: appeng@alliedmachine.com

i = Imperial (in)
m = Metric (mm)

Screws sold in multiples of 10



GEN3SYS XT Drill Inserts

14 Series | Diameter Range: 0.5512" - 0.5905" (14.00 mm - 14.99 mm)

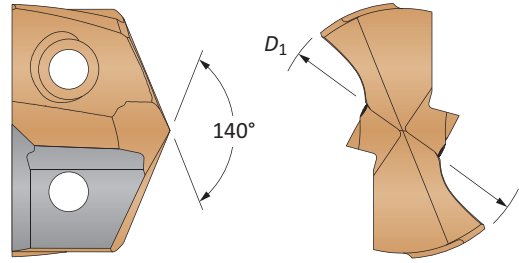
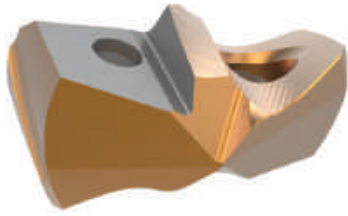

Carbide Substrate	Insert			Standard Part No.	Low Rake Part No.	Cast Iron Part No.	Stainless Part No.
	Fractional Equivalent	D_1 inch	D_1 mm				
C1 (K35)	-	0.5512	14.00	7C114P-14	7C114P-14LR	-	-
	9/16	0.5625	14.29	7C114P-0018	7C114P-0018LR	-	-
	-	0.5709	14.50	7C114P-14.5	7C114P-14.5LR	-	-
	37/64	0.5781	14.68	7C114P-.578	7C114P-.578LR	-	-
	-	0.5827	14.80	7C114P-14.8	7C114P-14.8LR	-	-
C2 (K20)	-	0.5512	14.00	7C214P-14	7C214P-14LR	7C214P-14CI	7C214P-14AS
	9/16	0.5625	14.29	7C214P-0018	7C214P-0018LR	7C214P-0018CI	7C214P-0018AS
	-	0.5709	14.50	7C214P-14.5	7C214P-14.5LR	7C214P-14.5CI	7C214P-14.5AS
	37/64	0.5781	14.68	7C214P-.578	7C214P-.578LR	7C214P-.578CI	7C214P-.578AS
	-	0.5827	14.80	7C214P-14.8	7C214P-14.8LR	7C214P-14.8CI	7C214P-14.8AS

Inserts sold in multiples of 1

A20: 68 - 83

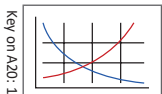

A20: 6 - 9



Key on A20: 1

Sizes not shown are available upon request.
When ordering, please follow the example below:

Imperial:	0.5200", 13 series, C2 = use Part No. 7C213P-.5200
Metric:	13.20 mm, 13 series, C2 = use Part No. 7C213P-13.20

GEN3SYS Drill Insert Holders

14 Series | Diameter Range: 0.5512" - 0.5905" (14.00 mm - 14.99 mm)

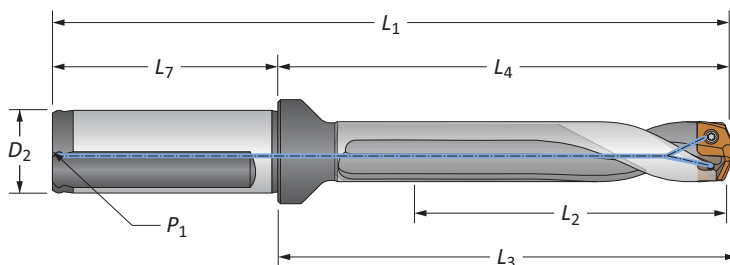

Straight and Helical

Flute	Length	Body				Shank				Flat	Part No.
		L ₂	L ₄	L ₃	L ₁	L ₇	D ₂	P ₁			
	3xD	1-49/64	2-27/32	2-61/64	4-7/8	2-1/32	3/4	1/8	YES	60314S-075F	
	5xD	2-61/64	4-1/32	4-1/8	6-1/16	2-1/32	3/4	1/8	YES	60514S-075F	
	7xD	4-1/8	5-13/64	5-5/16	7-15/64	2-1/32	3/4	1/8	YES	60714S-075F	
	Stub	11/16	1-3/4	1-55/64	3-25/32	2-1/32	3/4	1/8	YES	60114H-075F	
	3xD	1-49/64	2-27/32	2-61/64	4-7/8	2-1/32	3/4	1/8	YES	60314H-075F	
	3xD	1-49/64	2-27/32	2-61/64	4-7/8	2-1/32	3/4	1/8	NO	60314H-075C	
	5xD	2-61/64	4-1/32	4-1/8	6-1/16	2-1/32	3/4	1/8	YES	60514H-075F	
	5xD	2-61/64	4-1/32	4-1/8	6-1/16	2-1/32	3/4	1/8	NO	60514H-075C	
	7xD	4-1/8	5-13/64	5-5/16	7-15/64	2-1/32	3/4	1/8	YES	60714H-075F	
	7xD	4-1/8	5-13/64	5-5/16	7-15/64	2-1/32	3/4	1/8	NO	60714H-075C	
		3xD	44.8	72.2	74.9	122.2	50.0	20.0	1/8*	YES	60314S-20FM
5xD		75.0	102.4	104.9	152.4	50.0	20.0	1/8*	YES	60514S-20FM	
7xD		104.8	132.2	134.8	182.2	50.0	20.0	1/8*	YES	60714S-20FM	
Stub		17.5	44.5	47.2	94.5	50.0	20.0	1/8*	YES	60114H-20FM	
3xD		44.8	72.2	74.9	122.2	50.0	20.0	1/8*	YES	60314H-20FM	
3xD		44.8	72.2	74.9	122.2	50.0	20.0	1/8*	NO	60314H-20CM	
5xD		75.0	102.4	104.9	152.4	50.0	20.0	1/8*	YES	60514H-20FM	
5xD		75.0	102.4	104.9	152.4	50.0	20.0	1/8*	NO	60514H-20CM	
7xD		104.8	132.2	134.8	182.2	50.0	20.0	1/8*	YES	60714H-20FM	
7xD		104.8	132.2	134.8	182.2	50.0	20.0	1/8*	NO	60714H-20CM	

*Thread to BSP and ISO 7-1

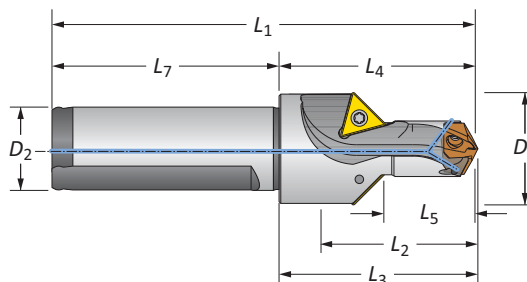

Drill / Chamfer

	Step		Body				Shank		Part No.	Chamfer Insert
	D ₅	L ₅	L ₂	L ₄	L ₃	L ₁	L ₇	D ₂		
i	1-3/64	53/64	1-3/64	1-3/4	1-55/64	3-25/32	2-1/32	3/4	60114C45-075F	TCMT-110204
m	26.7	21.0	26.8	44.6	47.2	94.6	50.0	20.0	60114C45-20FM	TCMT-110204

Connection Accessories

					Admissible Tightening Torque*
7247-IP7-1	7247N-IP7-1	8IP-7	8IP-7TL	8IP-7B	7.4 in-lbs (84 N-cm)

*Tightening torques are calculated with a friction coefficient of $\mu = 0.14$ and develop 90% of ultimate yield strength

Chamfer inserts sold separately in multiples of 10 | Screws sold in multiples of 10



i = Imperial (in)
m = Metric (mm)

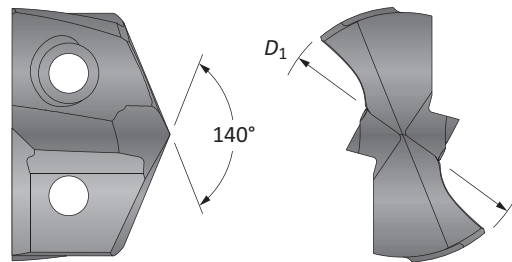
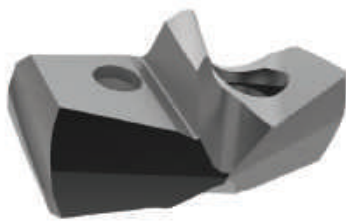

GEN3SYS XT Pro Drill Inserts

15 Series | Diameter Range: 0.5906" - 0.6298" (15.00 mm - 15.99 mm)



Fractional Equivalent	Insert				
	D_1 inch	D_1 mm	Part No. P	Part No. K	Part No. N
-	0.5906	15.00	XTP15-15.00	XTK15-15.00	XTN15-15.00
19/32	0.5937	15.08	XTP15-15.08	XTK15-15.08	XTN15-15.08
-	0.5984	15.20	XTP15-15.20	XTK15-15.20	XTN15-15.20
-	0.6024	15.30	XTP15-15.30	XTK15-15.30	XTN15-15.30
-	0.6063	15.40	XTP15-15.40	XTK15-15.40	XTN15-15.40
39/64	0.6094	15.48	XTP15-15.48	XTK15-15.48	XTN15-15.48
-	0.6102	15.50	XTP15-15.50	XTK15-15.50	XTN15-15.50
-	0.6142	15.60	XTP15-15.60	XTK15-15.60	XTN15-15.60
-	0.6181	15.70	XTP15-15.70	XTK15-15.70	XTN15-15.70
-	0.6220	15.80	XTP15-15.80	XTK15-15.80	XTN15-15.80
5/8	0.6252	15.88	XTP15-15.88	XTK15-15.88	XTN15-15.88

Inserts sold in multiples of 1

A20: 68 - 83

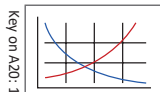

A20: 6 - 9



Sizes not shown are available upon request.
When ordering, please follow the example below:

Imperial:	0.5180", Steel, 13 series = use Part No. XTP13-13.16
Metric:	13.16 mm, Steel, 13 series = use Part No. XTP13-13.16

GEN3SYS XT Pro Drill Insert Holders

15 Series | Diameter Range: 0.5906" - 0.6298" (15.00 mm - 15.99 mm)

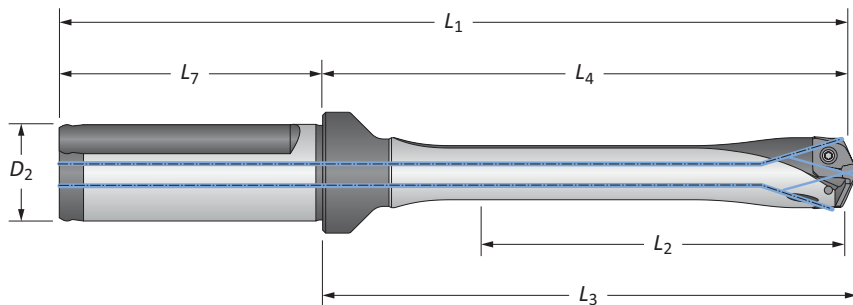

Flute	Body					Shank			Part No.
	Length	L ₂	L ₄	L ₃	L ₁	L ₇	D ₂	Flat	
i Straight	3xD	1-57/64	2-61/64	3-3/64	4-63/64	2-1/32	3/4	YES	HXT0315S-075F
	3xD	1-57/64	2-61/64	3-3/64	4-63/64	2-1/32	3/4	NO	HXT0315S-075C
	5xD	3-9/64	4-13/64	4-5/16	6-15/64	2-1/32	3/4	YES	HXT0515S-075F
	5xD	3-9/64	4-13/64	4-5/16	6-15/64	2-1/32	3/4	NO	HXT0515S-075C
	7xD	4-13/32	5-15/32	5-37/64	7-1/2	2-1/32	3/4	YES	HXT0715S-075F
	7xD	4-13/32	5-15/32	5-37/64	7-1/2	2-1/32	3/4	NO	HXT0715S-075C
	10xD	6-19/64	7-23/64	7-29/64	9-25/64	2-1/32	3/4	YES	HXT1015S-075F
	10xD	6-19/64	7-23/64	7-29/64	9-25/64	2-1/32	3/4	NO	HXT1015S-075C
m Straight	12xD	7-9/16	8-39/64	8-23/32	10-41/64	2-1/32	3/4	YES	HXT1215S-075F
	12xD	7-9/16	8-39/64	8-21/32	10-41/64	2-1/32	3/4	NO	HXT1215S-075C
	3xD	48.0	75.0	77.5	125.0	50.0	20.0	YES	HXT0315S-20FM
	3xD	48.0	75.0	77.5	125.0	50.0	20.0	NO	HXT0315S-20CM
	5xD	79.8	106.8	109.5	156.8	50.0	20.0	YES	HXT0515S-20FM
	5xD	79.8	106.8	109.5	156.8	50.0	20.0	NO	HXT0515S-20CM
	7xD	111.9	138.9	141.5	188.9	50.0	20.0	YES	HXT0715S-20FM
	7xD	111.9	138.9	141.5	188.9	50.0	20.0	NO	HXT0715S-20CM
	10xD	159.9	186.9	189.5	236.9	50.0	20.0	YES	HXT1015S-20FM
	10xD	159.9	186.9	189.5	236.9	50.0	20.0	NO	HXT1015S-20CM
	12xD	192.0	219.0	221.6	269.0	50.0	20.0	YES	HXT1215S-20FM
	12xD	192.0	219.0	221.6	269.0	50.0	20.0	NO	HXT1215S-20CM

Connection Accessories

					Admissible Tightening Torque*
7247-IP7-1	7247N-IP7-1	8IP-7	8IP-7TL	8IP-7B	7.4 in-lbs (84 N-cm)

*Tightening torques are calculated with a friction coefficient of $\mu = 0.14$ and develop 90% of ultimate yield strength

⚠ WARNING Refer to Speed and Feed charts for recommended adjustments to speeds and feeds. Refer to page A20: 86 for deep hole drilling guidelines in this section of the catalog. Visit www.alliedmachine.com/DeepHoleGuidelines for the most up-to-date information and procedures. Factory technical assistance is available for your specific applications through our Application Engineering Team. ext: 7611 | email: appeng@alliedmachine.com

i = Imperial (in)
m = Metric (mm)

Screws sold in multiples of 10

GEN3SYS XT Drill Inserts

15 Series | Diameter Range: 0.5906" - 0.6298" (15.00 mm - 15.99 mm)

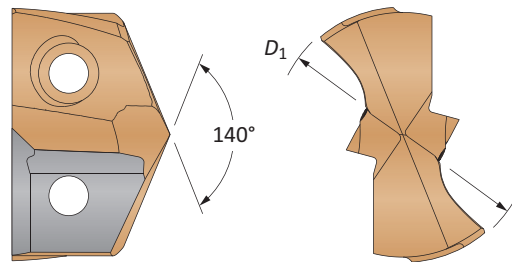
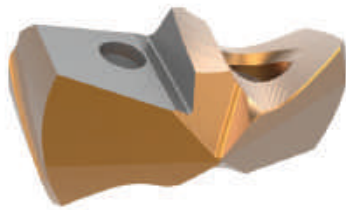

Carbide Substrate	Insert			Standard Part No.	Low Rake Part No.	Cast Iron Part No.	Stainless Part No.
	Fractional Equivalent	D_1 inch	D_1 mm				
C1 (K35)	-	0.5906	15.00	7C115P-15	7C115P-15LR	-	-
	19/32	0.5938	15.08	7C115P-0019	7C115P-0019LR	-	-
	-	0.6004	15.25	7C115P-15.25	7C115P-15.25LR	-	-
	39/64	0.6094	15.48	7C115P-.609	7C115P-.609LR	-	-
	-	0.6103	15.50	7C115P-15.5	7C115P-15.5LR	-	-
	-	0.6181	15.70	7C115P-.618	7C115P-.618LR	-	-
	5/8	0.6250	15.88	7C115P-0020	7C115P-0020LR	-	-
C2 (K20)	-	0.5906	15.00	7C215P-15	7C215P-15LR	7C215P-15CI	7C215P-15AS
	19/32	0.5938	15.08	7C215P-0019	7C215P-0019LR	7C215P-0019CI	7C215P-0019AS
	-	0.6004	15.25	7C215P-15.25	7C215P-15.25LR	7C215P-15.25CI	7C215P-15.25AS
	39/64	0.6094	15.48	7C215P-.609	7C215P-.609LR	7C215P-.609CI	7C215P-.609AS
	-	0.6103	15.50	7C215P-15.5	7C215P-15.5LR	7C215P-15.5CI	7C215P-15.5AS
	-	0.6181	15.70	7C215P-.618	7C215P-.618LR	7C215P-.618CI	7C215P-.618AS
	5/8	0.6250	15.88	7C215P-0020	7C215P-0020LR	7C215P-0020CI	7C215P-0020AS

Inserts sold in multiples of 1

A20: 68 - 83

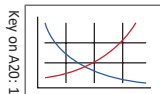

A20: 6 - 9



Sizes not shown are available upon request.
When ordering, please follow the example below:

Imperial:	0.5200", 13 series, C2 = use Part No. 7C213P-.5200
Metric:	13.20 mm, 13 series, C2 = use Part No. 7C213P-13.20

GEN3SYS Drill Insert Holders

15 Series | Diameter Range: 0.5906" - 0.6298" (15.00 mm - 15.99 mm)

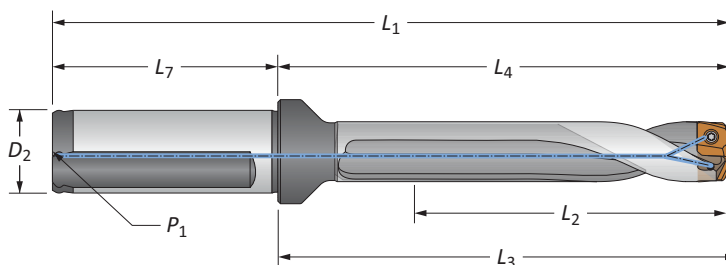

Straight and Helical

Flute	Length	Body				Shank				Part No.
		L ₂	L ₄	L ₃	L ₁	L ₇	D ₂	P ₁	Flat	
	3xD	1-57/64	2-61/64	3-3/64	4-63/64	2-1/32	3/4	1/8	YES	60315S-075F
	5xD	3-9/64	4-13/64	4-5/16	6-15/64	2-1/32	3/4	1/8	YES	60515S-075F
	7xD	4-13/32	5-15/32	5-37/64	7-1/2	2-1/32	3/4	1/8	YES	60715S-075F
	Stub	11/16	1-3/4	1-27/32	3-25/32	2-1/32	3/4	1/8	YES	60115H-075F
	3xD	1-57/64	2-61/64	3-3/64	4-63/64	2-1/32	3/4	1/8	YES	60315H-075F
	3xD	1-57/64	2-61/64	3-3/64	4-63/64	2-1/32	3/4	1/8	NO	60315H-075C
	5xD	3-9/64	4-13/64	4-5/16	6-15/64	2-1/32	3/4	1/8	YES	60515H-075F
	5xD	3-9/64	4-13/64	4-5/16	6-15/64	2-1/32	3/4	1/8	NO	60515H-075C
	7xD	4-13/32	5-15/32	5-37/64	7-1/2	2-1/32	3/4	1/8	YES	60715H-075F
	7xD	4-13/32	5-15/32	5-37/64	7-1/2	2-1/32	3/4	1/8	NO	60715H-075C
	3xD	48.0	75.0	77.5	125.0	50.0	20.0	1/8*	YES	60315S-20FM
	5xD	79.8	106.8	109.5	156.8	50.0	20.0	1/8*	YES	60515S-20FM
	7xD	111.9	138.9	141.5	188.9	50.0	20.0	1/8*	YES	60715S-20FM
	Stub	17.5	44.5	46.8	94.5	50.0	20.0	1/8*	YES	60115H-20FM
	3xD	48.0	75.0	77.5	125.0	50.0	20.0	1/8*	YES	60315H-20FM
	3xD	48.0	75.0	77.5	125.0	50.0	20.0	1/8*	NO	60315H-20CM
	5xD	79.8	106.8	109.5	156.8	50.0	20.0	1/8*	YES	60515H-20FM
	5xD	79.8	106.8	109.5	156.8	50.0	20.0	1/8*	NO	60515H-20CM
	7xD	111.9	138.9	141.5	188.9	50.0	20.0	1/8*	YES	60715H-20FM
	7xD	111.9	138.9	141.5	188.9	50.0	20.0	1/8*	NO	60715H-20CM

*Thread to BSP and ISO 7-1

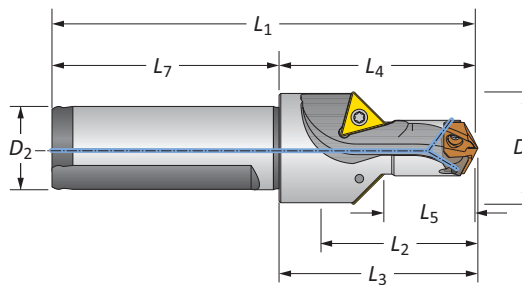

Drill / Chamfer

Step	Body				Shank		Part No.	Chamfer Insert		
	D ₅	L ₅	L ₂	L ₄	L ₃	L ₁			L ₇	D ₂
	1-1/16	57/64	1-1/16	1-47/64	1-27/32	3-49/64	2-1/32	3/4	60115C45-075F	TCMT-110204
	27.0	22.5	26.9	44.3	46.8	94.3	50.0	20.0	60115C45-20FM	TCMT-110204

Connection Accessories

Insert Screws	Nylon Locking Screws	Insert Driver	Preset Torque Hand Driver	Replacement Tips	Admissible Tightening Torque*
7247-IP7-1	7247N-IP7-1	8IP-7	8IP-7TL	8IP-7B	7.4 in-lbs (84 N-cm)

*Tightening torques are calculated with a friction coefficient of $\mu = 0.14$ and develop 90% of ultimate yield strength



Chamfer inserts sold separately in multiples of 10 | Screws sold in multiples of 10

= Imperial (in)
 = Metric (mm)

GEN3SYS XT Pro Drill Inserts

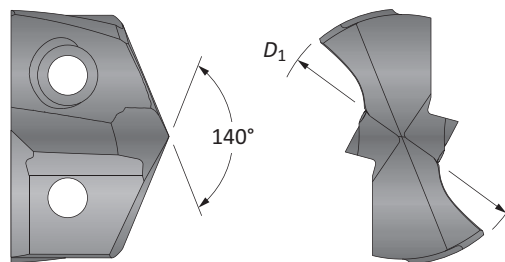
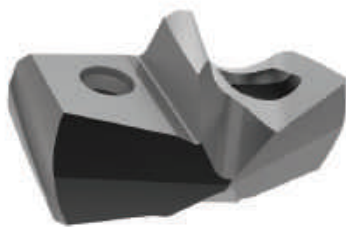
16 Series | Diameter Range: 0.6299" - 0.6692" (16.00 mm - 16.99 mm)



Fractional Equivalent	Insert				
	D_1 inch	D_1 mm	Part No. P	Part No. K	Part No. N
-	0.6299	16.00	XTP16-16.00	XTK16-16.00	XTN16-16.00
-	0.6331	16.08	XTP16-16.08	XTK16-16.08	XTN16-16.08
-	0.6378	16.20	XTP16-16.20	XTK16-16.20	XTN16-16.20
41/64	0.6406	16.27	XTP16-16.27	XTK16-16.27	XTN16-16.27
-	0.6457	16.40	XTP16-16.40	XTK16-16.40	XTN16-16.40
-	0.6496	16.50	XTP16-16.50	XTK16-16.50	XTN16-16.50
-	0.6535	16.60	XTP16-16.60	XTK16-16.60	XTN16-16.60
21/32	0.6563	16.67	XTP16-16.67	XTK16-16.67	XTN16-16.67
-	0.6614	16.80	XTP16-16.80	XTK16-16.80	XTN16-16.80
-	0.6654	16.90	XTP16-16.90	XTK16-16.90	XTN16-16.90

Inserts sold in multiples of 1

A20: 68 - 83

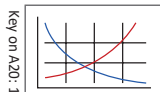

A20: 6 - 9



Sizes not shown are available upon request.

When ordering, please follow the example below:

Imperial:	0.5180", Steel, 13 series = use Part No. XTP13-13.16
Metric:	13.16 mm, Steel, 13 series = use Part No. XTP13-13.16

GEN3SYS XT Pro Drill Insert Holders

16 Series | Diameter Range: 0.6299" - 0.6692" (16.00 mm - 16.99 mm)

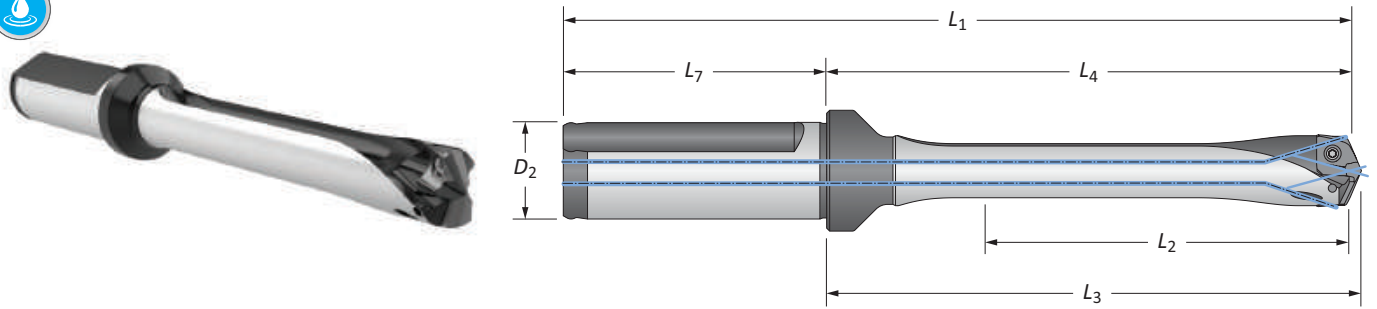

Flute	Body					Shank			Part No.
	Length	L ₂	L ₄	L ₃	L ₁	L ₇	D ₂	Flat	
i Straight	3xD	2	3-13/64	3-5/16	5-15/64	2-1/32	3/4	YES	HXT0316S-075F
	3xD	2	3-13/64	3-5/16	5-15/64	2-1/32	3/4	NO	HXT0316S-075C
	5xD	3-11/32	4-17/32	4-21/32	6-9/16	2-1/32	3/4	YES	HXT0516S-075F
	5xD	3-11/32	4-17/32	4-21/32	6-9/16	2-1/32	3/4	NO	HXT0516S-075C
	7xD	4-11/16	5-7/8	5-63/64	7-29/32	2-1/32	3/4	YES	HXT0716S-075F
	7xD	4-11/16	5-7/8	5-63/64	7-29/32	2-1/32	3/4	NO	HXT0716S-075C
	10xD	6-11/16	7-7/8	8	9-29/32	2-1/32	3/4	YES	HXT1016S-075F
	10xD	6-11/16	7-7/8	8	9-29/32	2-1/32	3/4	NO	HXT1016S-075C
	12xD	8-1/32	9-7/32	9-21/64	11-1/4	2-1/32	3/4	YES	HXT1216S-075F
12xD	8-1/32	9-7/32	9-21/64	11-1/4	2-1/32	3/4	NO	HXT1216S-075C	
m Straight	3xD	50.8	81.3	84.2	131.3	50.0	20.0	YES	HXT0316S-20FM
	3xD	50.8	81.3	84.2	131.3	50.0	20.0	NO	HXT0316S-20CM
	5xD	85.0	115.1	118.2	165.1	50.0	20.0	YES	HXT0516S-20FM
	5xD	85.0	115.1	118.2	165.1	50.0	20.0	NO	HXT0516S-20CM
	7xD	119.0	149.2	152.0	199.2	50.0	20.0	YES	HXT0716S-20FM
	7xD	119.0	149.2	152.0	199.2	50.0	20.0	NO	HXT0716S-20CM
	10xD	169.9	200.0	203.2	250.0	50.0	20.0	YES	HXT1016S-20FM
	10xD	169.9	200.0	203.2	250.0	50.0	20.0	NO	HXT1016S-20CM
	12xD	204.0	234.3	237.2	284.3	50.0	20.0	YES	HXT1216S-20FM
12xD	204.0	234.3	237.2	284.3	50.0	20.0	NO	HXT1216S-20CM	

Connection Accessories

					Admissible Tightening Torque*
72556-IP8-1	72556N-IP8-1	8IP-8	8IP-8TL	8IP-8B	15.5 in-lbs (175 N-cm)

*Tightening torques are calculated with a friction coefficient of $\mu = 0.14$ and develop 90% of ultimate yield strength

⚠ WARNING Refer to Speed and Feed charts for recommended adjustments to speeds and feeds. Refer to page A20: 86 for deep hole drilling guidelines in this section of the catalog. Visit www.alliedmachine.com/DeepHoleGuidelines for the most up-to-date information and procedures. Factory technical assistance is available for your specific applications through our Application Engineering Team. ext: 7611 | email: appeng@alliedmachine.com

i = Imperial (in)
m = Metric (mm)

Screws sold in multiples of 10

A DRILLING
B BORING
C REAMING
D BURNISHING
E THREADING
X SPECIALS

GEN3SYS XT Drill Inserts

16 Series | Diameter Range: 0.6299" - 0.6692" (16.00 mm - 16.99 mm)

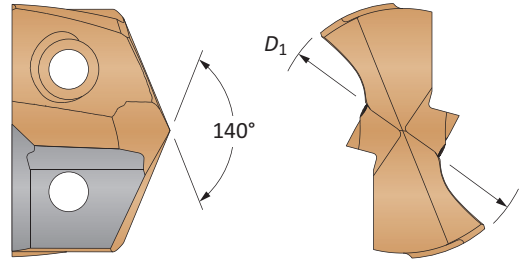

Carbide Substrate	Insert			Standard Part No.	Low Rake Part No.	Cast Iron Part No.	Stainless Part No.
	Fractional Equivalent	D ₁ inch	D ₁ mm				
C1 (K35)	-	0.6299	16.00	7C116P-16	7C116P-16LR	-	-
	-	0.6331	16.08	7C116P-16.08	7C116P-16.08LR	-	-
	41/64	0.6406	16.27	7C116P-.640	7C116P-.640LR	-	-
	-	0.6496	16.50	7C116P-16.5	7C116P-16.5LR	-	-
	21/32	0.6563	16.67	7C116P-0021	7C116P-0021LR	-	-
C2 (K20)	-	0.6299	16.00	7C216P-16	7C216P-16LR	7C216P-16CI	7C216P-16AS
	-	0.6331	16.08	7C216P-16.08	7C216P-16.08LR	7C216P-16.08CI	7C216P-16.08AS
	41/64	0.6406	16.27	7C216P-.640	7C216P-.640LR	7C216P-.640CI	7C216P-.640AS
	-	0.6496	16.50	7C216P-16.5	7C216P-16.5LR	7C216P-16.5CI	7C216P-16.5AS
	21/32	0.6563	16.67	7C216P-0021	7C216P-0021LR	7C216P-0021CI	7C216P-0021AS

Inserts sold in multiples of 1

A DRILLING

B BORING

C REAMING

D BURNISHING

F THREADING

X SPECIALS

A20: 68 - 83

A20: 6 - 9

Sizes not shown are available upon request. When ordering, please follow the example below:	
Imperial:	0.5200", 13 series, C2 = use Part No. 7C213P-.5200
Metric:	13.20 mm, 13 series, C2 = use Part No. 7C213P-13.20

GEN3SYS Drill Insert Holders

16 Series | Diameter Range: 0.6299" - 0.6692" (16.00 mm - 16.99 mm)

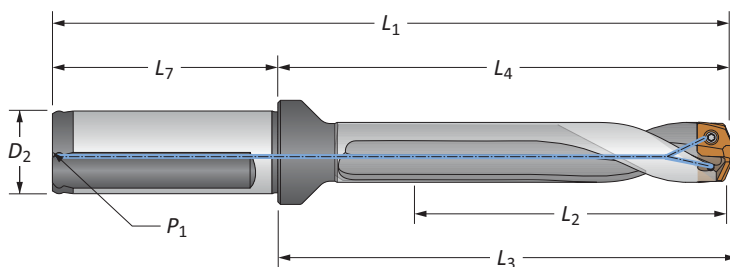

Straight and Helical

Flute	Length	Body				Shank				Flat	Part No.
		L ₂	L ₄	L ₃	L ₁	L ₇	D ₂	P ₁			
	3xD	2	3-13/64	3-5/16	5-15/64	2-1/32	3/4	1/8	YES	60316S-075F	
	5xD	3-11/32	4-17/32	4-21/32	6-9/16	2-1/32	3/4	1/8	YES	60516S-075F	
	7xD	4-11/16	5-7/8	5-63/64	7-29/32	2-1/32	3/4	1/8	YES	60716S-075F	
	Stub	13/16	2	2-7/64	4-1/32	2-1/32	3/4	1/8	YES	60116H-075F	
	3xD	2	3-13/64	3-5/16	5-15/64	2-1/32	3/4	1/8	YES	60316H-075F	
	3xD	2	3-13/64	3-5/16	5-15/64	2-1/32	3/4	1/8	NO	60316H-075C	
	5xD	3-11/32	4-17/32	4-21/32	6-9/16	2-1/32	3/4	1/8	YES	60516H-075F	
	5xD	3-11/32	4-17/32	4-21/32	6-9/16	2-1/32	3/4	1/8	NO	60516H-075C	
	7xD	4-11/16	5-7/8	5-63/64	7-29/32	2-1/32	3/4	1/8	YES	60716H-075F	
	7xD	4-11/16	5-7/8	5-63/64	7-29/32	2-1/32	3/4	1/8	NO	60716H-075C	
		3xD	50.8	81.3	84.2	131.3	50.0	20.0	1/8*	YES	60316S-20FM
5xD		85.0	115.1	118.2	165.1	50.0	20.0	1/8*	YES	60516S-20FM	
7xD		119.0	149.2	152.0	199.2	50.0	20.0	1/8*	YES	60716S-20FM	
Stub		21.0	50.8	53.7	100.8	50.0	20.0	1/8*	YES	60116H-20FM	
3xD		50.8	81.3	84.2	131.3	50.0	20.0	1/8*	YES	60316H-20FM	
3xD		50.8	81.3	84.2	131.3	50.0	20.0	1/8*	NO	60316H-20CM	
5xD		85.0	115.1	118.2	165.1	50.0	20.0	1/8*	YES	60516H-20FM	
5xD		85.0	115.1	118.2	165.1	50.0	20.0	1/8*	NO	60516H-20CM	
7xD		119.0	149.2	152.0	199.2	50.0	20.0	1/8*	YES	60716H-20FM	
7xD		119.0	149.2	152.0	199.2	50.0	20.0	1/8*	NO	60716H-20CM	

*Thread to BSP and ISO 7-1

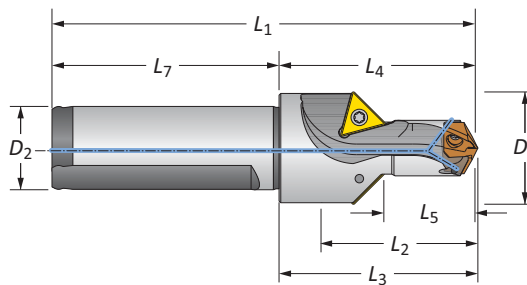

Drill / Chamfer

	Step		Body				Shank		Part No.	Chamfer Insert
	D ₅	L ₅	L ₂	L ₄	L ₃	L ₁	L ₇	D ₂		
i	1-1/16	61/64	1-19/64	2	2-7/64	4-1/32	2-1/32	3/4	60116C45-075F	TCMT-110204
m	27.0	24.0	33.1	50.8	53.7	100.8	50.0	20.0	60116C45-20FM	TCMT-110204

Connection Accessories

					Admissible Tightening Torque*
72556-IP8-1	72556N-IP8-1	8IP-8	8IP-8TL	8IP-8B	15.5 in-lbs (175 N-cm)

*Tightening torques are calculated with a friction coefficient of $\mu = 0.14$ and develop 90% of ultimate yield strength



Chamfer inserts sold separately in multiples of 10 | Screws sold in multiples of 10

i = Imperial (in)
m = Metric (mm)

GEN3SYS XT Pro Drill Inserts

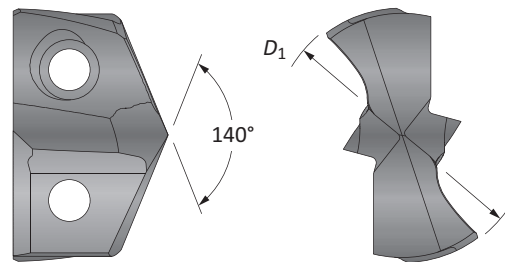
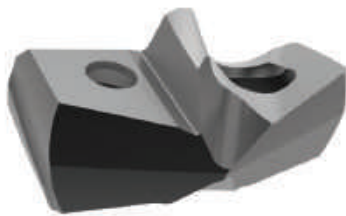
17 Series | Diameter Range: 0.6693" - 0.7086" (17.00 mm - 17.99 mm)



Fractional Equivalent	Insert				
	D_1 inch	D_1 mm	Part No. P	Part No. K	Part No. N
-	0.6693	17.00	XTP17-17.00	XTK17-17.00	XTN17-17.00
43/64	0.6720	17.07	XTP17-17.07	XTK17-17.07	XTN17-17.07
-	0.6732	17.10	XTP17-17.10	XTK17-17.10	XTN17-17.10
-	0.6772	17.20	XTP17-17.20	XTK17-17.20	XTN17-17.20
-	0.6811	17.30	XTP17-17.30	XTK17-17.30	XTN17-17.30
-	0.6850	17.40	XTP17-17.40	XTK17-17.40	XTN17-17.40
11/16	0.6874	17.46	XTP17-17.46	XTK17-17.46	XTN17-17.46
-	0.6890	17.50	XTP17-17.50	XTK17-17.50	XTN17-17.50
-	0.6929	17.60	XTP17-17.60	XTK17-17.60	XTN17-17.60
-	0.6969	17.70	XTP17-17.70	XTK17-17.70	XTN17-17.70
-	0.7008	17.80	XTP17-17.80	XTK17-17.80	XTN17-17.80
45/64	0.7031	17.86	XTP17-17.86	XTK17-17.86	XTN17-17.86
-	0.7047	17.90	XTP17-17.90	XTK17-17.90	XTN17-17.90

Inserts sold in multiples of 1

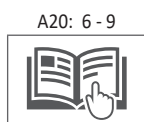
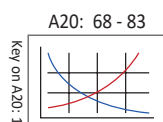

Sizes not shown are available upon request.	
When ordering, please follow the example below:	
Imperial:	0.5180", Steel, 13 series = use Part No. XTP13-13.16
Metric:	13.16 mm, Steel, 13 series = use Part No. XTP13-13.16

GEN3SYS XT Pro Drill Insert Holders

17 Series | Diameter Range: 0.6693" - 0.7086" (17.00 mm - 17.99 mm)

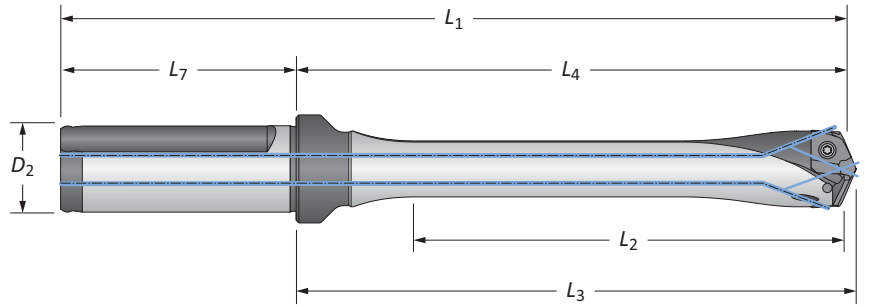

Flute	Body					Shank			Part No.
	Length	L ₂	L ₄	L ₃	L ₁	L ₇	D ₂	Flat	
i Straight 	3xD	2-1/8	3-19/64	3-27/64	5-21/64	2-1/32	3/4	YES	HXT0317S-075F
	3xD	2-1/8	3-19/64	3-27/64	5-21/64	2-1/32	3/4	NO	HXT0317S-075C
	5xD	3-35/64	4-23/32	4-27/32	6-3/4	2-1/32	3/4	YES	HXT0517S-075F
	5xD	3-35/64	4-23/32	4-27/32	6-3/4	2-1/32	3/4	NO	HXT0517S-075C
	7xD	4-61/64	6-9/64	6-1/4	8-11/64	2-1/32	3/4	YES	HXT0717S-075F
	7xD	4-61/64	6-9/64	6-1/4	8-11/64	2-1/32	3/4	NO	HXT0717S-075C
	10xD	7-5/64	8-17/64	8-3/8	10-19/64	2-1/32	3/4	YES	⚠ HXT1017S-075F
	10xD	7-5/64	8-17/64	8-3/8	10-19/64	2-1/32	3/4	NO	⚠ HXT1017S-075C
m Straight 	3xD	54.0	83.8	86.9	133.8	50.0	20.0	YES	HXT0317S-20FM
	3xD	54.0	83.8	86.9	133.8	50.0	20.0	NO	HXT0317S-20CM
	5xD	90.0	119.8	122.9	169.8	50.0	20.0	YES	HXT0517S-20FM
	5xD	90.0	119.8	122.9	169.8	50.0	20.0	NO	HXT0517S-20CM
	7xD	125.8	156.0	158.9	206.0	50.0	20.0	YES	HXT0717S-20FM
	7xD	125.8	156.0	158.9	206.0	50.0	20.0	NO	HXT0717S-20CM
	10xD	179.8	209.9	212.8	259.9	50.0	20.0	YES	⚠ HXT1017S-20FM
	10xD	179.8	209.9	212.8	259.9	50.0	20.0	NO	⚠ HXT1017S-20CM
i Straight 	12xD	216.0	246.0	248.9	296.0	50.0	20.0	YES	⚠ HXT1217S-075F
	12xD	216.0	246.0	248.9	296.0	50.0	20.0	NO	⚠ HXT1217S-075C
m Straight 	12xD	216.0	246.0	248.9	296.0	50.0	20.0	YES	⚠ HXT1217S-20FM
	12xD	216.0	246.0	248.9	296.0	50.0	20.0	NO	⚠ HXT1217S-20CM

Connection Accessories

					Admissible Tightening Torque*
72567-IP8-1	72567N-IP8-1	8IP-8	8IP-8TL	8IP-8B	15.5 in-lbs (175 N-cm)

*Tightening torques are calculated with a friction coefficient of $\mu = 0.14$ and develop 90% of ultimate yield strength

⚠ WARNING Refer to Speed and Feed charts for recommended adjustments to speeds and feeds. Refer to page A20: 86 for deep hole drilling guidelines in this section of the catalog. Visit www.alliedmachine.com/DeepHoleGuidelines for the most up-to-date information and procedures. Factory technical assistance is available for your specific applications through our Application Engineering Team. ext: 7611 | email: appeng@alliedmachine.com

i = Imperial (in)
m = Metric (mm)

Screws sold in multiples of 10

A DRILLING
B BORING
C REAMING
D BURNISHING
E THREADING
X SPECIALS



GEN3SYS XT Drill Inserts

17 Series | Diameter Range: 0.6693" - 0.7086" (17.00 mm - 17.99 mm)

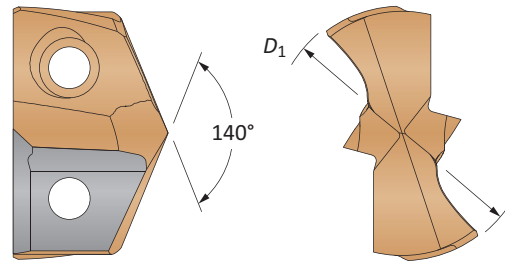
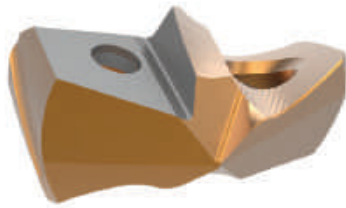

Carbide Substrate	Insert			Standard Part No.	Low Rake Part No.	Cast Iron Part No.	Stainless Part No.
	Fractional Equivalent	D ₁ inch	D ₁ mm				
C1 (K35)		0.6693	17.00	7C117P-17	7C117P-17LR	-	-
	43/64	0.6719	17.07	7C117P-.671	7C117P-.671LR	-	-
		0.6732	17.10	7C117P-17.1	7C117P-17.1LR	-	-
		0.6772	17.20	7C117P-17.2	7C117P-17.2LR	-	-
	11/16	0.6875	17.46	7C117P-0022	7C117P-0022LR	-	-
		0.6890	17.50	7C117P-17.5	7C117P-17.5LR	-	-
	45/64	0.7031	17.86	7C117P-.703	7C117P-.703LR	-	-
C2 (K20)		0.6693	17.00	7C217P-17	7C217P-17LR	7C217P-17CI	7C217P-17AS
	43/64	0.6719	17.07	7C217P-.671	7C217P-.671LR	7C217P-.671CI	7C217P-.671AS
		0.6732	17.10	7C217P-17.1	7C217P-17.1LR	7C217P-17.1CI	7C217P-17.1AS
		0.6772	17.20	7C217P-17.2	7C217P-17.2LR	7C217P-17.2CI	7C217P-17.2AS
	11/16	0.6875	17.46	7C217P-0022	7C217P-0022LR	7C217P-0022CI	7C217P-0022AS
		0.6890	17.50	7C217P-17.5	7C217P-17.5LR	7C217P-17.5CI	7C217P-17.5AS
	45/64	0.7031	17.86	7C217P-.703	7C217P-.703LR	7C217P-.703CI	7C217P-.703AS

Inserts sold in multiples of 1

A20: 68 - 83

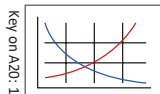

A20: 6 - 9



Sizes not shown are available upon request.
When ordering, please follow the example below:

Imperial:	0.5200", 13 series, C2 = use Part No. 7C213P-.5200
Metric:	13.20 mm, 13 series, C2 = use Part No. 7C213P-13.20

GEN3SYS Drill Insert Holders

17 Series | Diameter Range: 0.6693" - 0.7086" (17.00 mm - 17.99 mm)

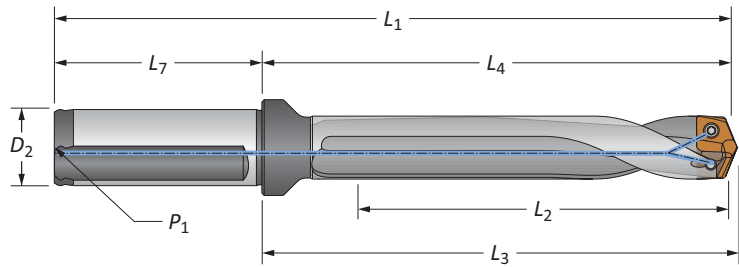

Straight and Helical

Flute	Length	Body				Shank				Flat	Part No.
		L ₂	L ₄	L ₃	L ₁	L ₇	D ₂	P ₁			
Straight	3xD	2-1/8	3-19/64	3-27/64	5-21/64	2-1/32	3/4	1/8	YES	60317S-075F	
	5xD	3-35/64	4-23/32	4-27/32	6-3/4	2-1/32	3/4	1/8	YES	60517S-075F	
	7xD	4-61/64	6-9/64	6-1/4	8-11/64	2-1/32	3/4	1/8	YES	60717S-075F	
Helical	Stub	13/16	1-63/64	2-7/64	4-1/64	2-1/32	3/4	1/8	YES	60117H-075F	
	3xD	2-1/8	3-19/64	3-27/64	5-21/64	2-1/32	3/4	1/8	YES	60317H-075F	
	3xD	2-1/8	3-19/64	3-27/64	5-21/64	2-1/32	3/4	1/8	NO	60317H-075C	
	5xD	3-35/64	4-23/32	4-27/32	6-3/4	2-1/32	3/4	1/8	YES	60517H-075F	
	5xD	3-35/64	4-23/32	4-27/32	6-3/4	2-1/32	3/4	1/8	NO	60517H-075C	
	7xD	4-61/64	6-9/64	6-1/4	8-11/64	2-1/32	3/4	1/8	YES	60717H-075F	
	7xD	4-61/64	6-9/64	6-1/4	8-11/64	2-1/32	3/4	1/8	NO	60717H-075C	
	Metric	3xD	54.0	83.8	86.9	133.8	50.0	20.0	1/8*	YES	60317S-20FM
5xD		90.0	119.8	122.9	169.8	50.0	20.0	1/8*	YES	60517S-20FM	
7xD		125.8	156.0	158.9	206.0	50.0	20.0	1/8*	YES	60717S-20FM	
Stub		20.6	50.5	53.5	100.5	50.0	20.0	1/8*	YES	60117H-20FM	
3xD		54.0	83.8	86.9	133.8	50.0	20.0	1/8*	YES	60317H-20FM	
3xD		54.0	83.8	86.9	133.8	50.0	20.0	1/8*	NO	60317H-20CM	
5xD		90.0	119.8	122.9	169.8	50.0	20.0	1/8*	YES	60517H-20FM	
5xD		90.0	119.8	122.9	169.8	50.0	20.0	1/8*	NO	60517H-20CM	
7xD		125.8	156.0	158.9	206.0	50.0	20.0	1/8*	YES	60717H-20FM	
7xD		125.8	156.0	158.9	206.0	50.0	20.0	1/8*	NO	60717H-20CM	

*Thread to BSP and ISO 7-1

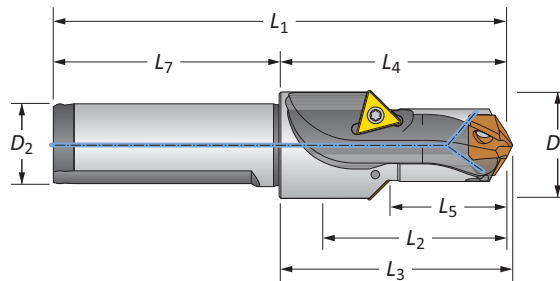

Drill / Chamfer

Step	Body				Shank			Part No.	Chamfer Insert
	D ₅	L ₅	L ₂	L ₄	L ₃	L ₁	L ₇		
1	1	1-5/16	1-63/64	2-7/64	4-1/64	2-1/32	3/4	60117C45-075F	TCMT-110204
25.4	25.5	33.3	50.5	53.4	100.5	50.0	20.0	60117C45-20FM	TCMT-110204

Connection Accessories

					Admissible Tightening Torque*
72567-IP8-1	72567N-IP8-1	8IP-8	8IP-8TL	8IP-8B	15.5 in-lbs (175 N-cm)

*Tightening torques are calculated with a friction coefficient of $\mu = 0.14$ and develop 90% of ultimate yield strength



Chamfer inserts sold separately in multiples of 10 | Screws sold in multiples of 10

= Imperial (in)
 = Metric (mm)

GEN3SYS XT Pro Drill Inserts

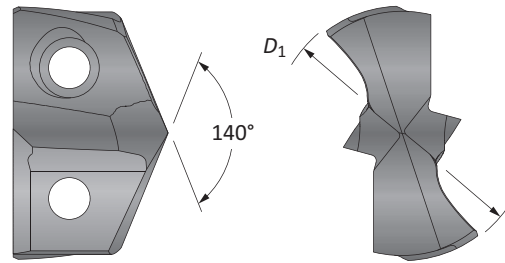
18 Series | Diameter Range: 0.7087" - 0.7873" (18.00 mm - 19.99 mm)



Fractional Equivalent	Insert				
	D_1 inch	D_1 mm	Part No. P	Part No. K	Part No. N
-	0.7087	18.00	XTP18-18.00	XTK18-18.00	XTN18-18.00
-	0.7126	18.10	XTP18-18.10	XTK18-18.10	XTN18-18.10
-	0.7165	18.20	XTP18-18.20	XTK18-18.20	XTN18-18.20
23/32	0.7189	18.26	XTP18-18.26	XTK18-18.26	XTN18-18.26
-	0.7205	18.30	XTP18-18.30	XTK18-18.30	XTN18-18.30
-	0.7244	18.40	XTP18-18.40	XTK18-18.40	XTN18-18.40
-	0.7283	18.50	XTP18-18.50	XTK18-18.50	XTN18-18.50
-	0.7323	18.60	XTP18-18.60	XTK18-18.60	XTN18-18.60
47/64	0.7343	18.65	XTP18-18.65	XTK18-18.65	XTN18-18.65
-	0.7362	18.70	XTP18-18.70	XTK18-18.70	XTN18-18.70
-	0.7402	18.80	XTP18-18.80	XTK18-18.80	XTN18-18.80
-	0.7441	18.90	XTP18-18.90	XTK18-18.90	XTN18-18.90
-	0.7480	19.00	XTP18-19.00	XTK18-19.00	XTN18-19.00
3/4	0.7500	19.05	XTP18-19.05	XTK18-19.05	XTN18-19.05
-	0.7520	19.10	XTP18-19.10	XTK18-19.10	XTN18-19.10
-	0.7559	19.20	XTP18-19.20	XTK18-19.20	XTN18-19.20
-	0.7579	19.25	XTP18-19.25	XTK18-19.25	XTN18-19.25
-	0.7598	19.30	XTP18-19.30	XTK18-19.30	XTN18-19.30
-	0.7638	19.40	XTP18-19.40	XTK18-19.40	XTN18-19.40
49/64	0.7657	19.45	XTP18-19.45	XTK18-19.45	XTN18-19.45
-	0.7677	19.50	XTP18-19.50	XTK18-19.50	XTN18-19.50
-	0.7717	19.60	XTP18-19.60	XTK18-19.60	XTN18-19.60
-	0.7756	19.70	XTP18-19.70	XTK18-19.70	XTN18-19.70
-	0.7795	19.80	XTP18-19.80	XTK18-19.80	XTN18-19.80
25/32	0.7811	19.84	XTP18-19.84	XTK18-19.84	XTN18-19.84
-	0.7835	19.90	XTP18-19.90	XTK18-19.90	XTN18-19.90

Inserts sold in multiples of 1

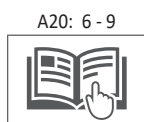
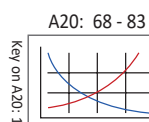

Sizes not shown are available upon request.	
When ordering, please follow the example below:	
Imperial:	0.5180", Steel, 13 series = use Part No. XTP13-13.16
Metric:	13.16 mm, Steel, 13 series = use Part No. XTP13-13.16

GEN3SYS XT Pro Drill Insert Holders

18 Series | Diameter Range: 0.7087" - 0.7873" (18.00 mm - 19.99 mm)

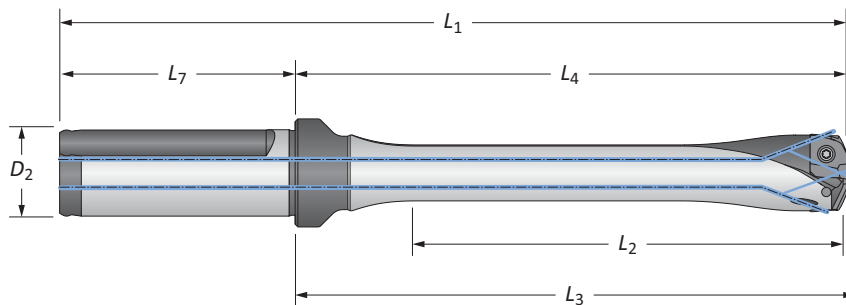

Flute	Body					Shank			Part No.
	Length	L ₂	L ₄	L ₃	L ₁	L ₇	D ₂	Flat	
i Straight	3xD	2-23/64	3-45/64	3-13/16	5-63/64	2-9/32	1	YES	HXT0318S-100F
	3xD	2-23/64	3-45/64	3-13/16	5-63/64	2-9/32	1	NO	HXT0318S-100C
	5xD	3-15/16	5-17/64	5-25/64	7-35/64	2-9/32	1	YES	HXT0518S-100F
	5xD	3-15/16	5-17/64	5-25/64	7-35/64	2-9/32	1	NO	HXT0518S-100C
	7xD	5-33/64	6-27/32	6-61/64	9-1/8	2-9/32	1	YES	HXT0718S-100F
	7xD	5-33/64	6-27/32	6-61/64	9-1/8	2-9/32	1	NO	HXT0718S-100C
	10xD	7-7/8	9-7/32	9-5/16	11-31/64	2-9/32	1	YES	HXT1018S-100F
	10xD	7-7/8	9-7/32	9-5/16	11-31/64	2-9/32	1	NO	HXT1018S-100C
m Straight	12xD	9-7/16	10-25/32	10-57/64	13-1/16	2-9/32	1	YES	HXT1218S-100F
	12xD	9-7/16	10-25-32	10-57/64	13-1/16	2-9/32	1	NO	HXT1218S-100C
	3xD	60.0	94.0	96.8	150.0	56.0	25.0	YES	HXT0318S-25FM
	3xD	60.0	94.0	96.8	150.0	56.0	25.0	NO	HXT0318S-25CM
	5xD	100.0	133.7	136.8	189.7	56.0	25.0	YES	HXT0518S-25FM
	5xD	100.0	133.7	136.8	189.7	56.0	25.0	NO	HXT0518S-25CM
	7xD	140.0	173.4	176.8	229.4	56.0	25.0	YES	HXT0718S-25FM
	7xD	140.0	173.4	176.8	229.4	56.0	25.0	NO	HXT0718S-25CM
	10xD	199.9	234.1	236.7	290.1	56.0	25.0	YES	HXT1018S-25FM
	10xD	199.9	234.1	236.7	290.1	56.0	25.0	NO	HXT1018S-25CM
	12xD	240.0	273.9	276.7	329.9	56.0	25.0	YES	HXT1218S-25FM
	12xD	240.0	273.9	276.7	329.9	56.0	25.0	NO	HXT1218S-25CM

Connection Accessories

					Admissible Tightening Torque*
7375-IP9-1	7375N-IP9-1	8IP-9	8IP-9TL	8IP-9B	27.0 in-lbs (305 N-cm)

*Tightening torques are calculated with a friction coefficient of $\mu = 0.14$ and develop 90% of ultimate yield strength

⚠ WARNING Refer to Speed and Feed charts for recommended adjustments to speeds and feeds. Refer to page A20: 86 for deep hole drilling guidelines in this section of the catalog. Visit www.alliedmachine.com/DeepHoleGuidelines for the most up-to-date information and procedures. Factory technical assistance is available for your specific applications through our Application Engineering Team. ext: 7611 | email: appeng@alliedmachine.com

i = Imperial (in)
m = Metric (mm)

Screws sold in multiples of 10

A

DRILLING

B

BORING

C

REAMING

D

BURNISHING

E

THREADING

X

SPECIALS

GEN3SYS XT Drill Inserts

18 Series | Diameter Range: 0.7087" - 0.7873" (18.00 mm - 19.99 mm)

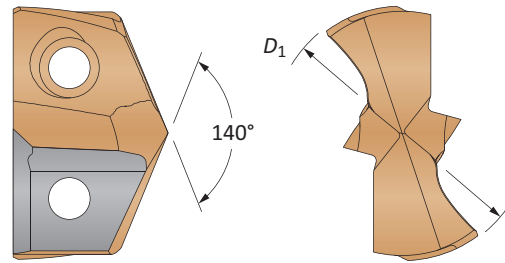
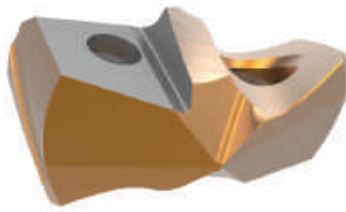

Carbide Substrate	Insert			Standard Part No.	Low Rake Part No.	Cast Iron Part No.	Stainless Part No.
	Fractional Equivalent	D_1 inch	D_1 mm				
C1 (K35)	-	0.7087	18.00	7C118P-18	7C118P-18LR	-	-
	23/32	0.7188	18.26	7C118P-0023	7C118P-0023LR	-	-
	-	0.7283	18.50	7C118P-18.5	7C118P-18.5LR	-	-
	47/64	0.7344	18.65	7C118P-.734	7C118P-.734LR	-	-
	-	0.7480	19.00	7C118P-19	7C118P-19LR	-	-
	3/4	0.7500	19.05	7C118P-0024	7C118P-0024LR	-	-
	-	0.7580	19.25	7C118P-.758	7C118P-.758LR	-	-
	49/64	0.7656	19.45	7C118P-.765	7C118P-.765LR	-	-
	-	0.7677	19.50	7C118P-19.5	7C118P-19.5LR	-	-
	-	0.7795	19.80	7C118P-19.8	7C118P-19.8LR	-	-
-	0.7813	19.85	7C118P-0025	7C118P-0025LR	-	-	
C2 (K20)	-	0.7087	18.00	7C218P-18	7C218P-18LR	7C218P-18CI	7C218P-18AS
	23/32	0.7188	18.26	7C218P-0023	7C218P-0023LR	7C218P-0023CI	7C218P-0023AS
	-	0.7283	18.50	7C218P-18.5	7C218P-18.5LR	7C218P-18.5CI	7C218P-18.5AS
	47/64	0.7344	18.65	7C218P-.734	7C218P-.734LR	7C218P-.734CI	7C218P-.734AS
	-	0.7480	19.00	7C218P-19	7C218P-19LR	7C218P-19CI	7C218P-19AS
	3/4	0.7500	19.05	7C218P-0024	7C218P-0024LR	7C218P-0024CI	7C218P-0024AS
	-	0.7580	19.25	7C218P-.758	7C218P-.758LR	7C218P-.758CI	7C218P-.758AS
	49/64	0.7656	19.45	7C218P-.765	7C218P-.765LR	7C218P-.765CI	7C218P-.765AS
	-	0.7677	19.50	7C218P-19.5	7C218P-19.5LR	7C218P-19.5CI	7C218P-19.5AS
	-	0.7795	19.80	7C218P-19.8	7C218P-19.8LR	7C218P-19.8CI	7C218P-19.8AS
-	0.7813	19.85	7C218P-0025	7C218P-0025LR	7C218P-0025CI	7C218P-0025AS	

Inserts sold in multiples of 1

A20: 68 - 83

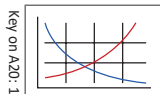

A20: 6 - 9



Sizes not shown are available upon request.

When ordering, please follow the example below:

Imperial:	0.5200", 13 series, C2 = use Part No. 7C213P-.5200
Metric:	13.20 mm, 13 series, C2 = use Part No. 7C213P-13.20

GEN3SYS Drill Insert Holders

18 Series | Diameter Range: 0.7087" - 0.7873" (18.00 mm - 19.99 mm)

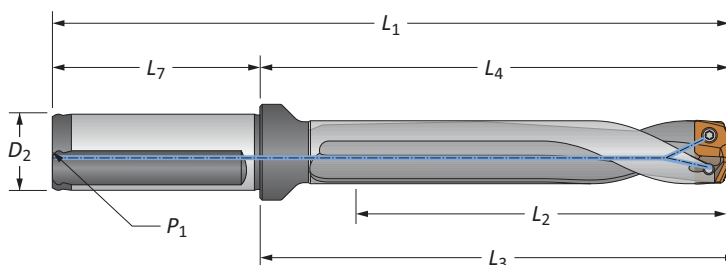

Straight and Helical

Flute	Length	Body				Shank				Flat	Part No.
		L ₂	L ₄	L ₃	L ₁	L ₇	D ₂	P ₁			
	3xD	2-23/64	3-45/64	3-13/16	5-63/64	2-9/32	1	1/8	YES	60318S-100F	
	5xD	3-15/16	5-17/64	5-25/64	7-35/64	2-9/32	1	1/8	YES	60518S-100F	
	7xD	5-33/64	6-27/32	6-61/64	9-1/8	2-9/32	1	1/8	YES	60718S-100F	
	Stub	7/8	2-13/64	2-5/16	4-31/64	2-9/32	1	1/8	YES	60118H-100F	
	3xD	2-23/64	3-45/64	3-13/16	5-63/64	2-9/32	1	1/8	YES	60318H-100F	
	3xD	2-23/64	3-45/64	3-13/16	5-63/64	2-9/32	1	1/8	NO	60318H-100C	
	5xD	3-15/16	5-17/64	5-25/64	7-35/64	2-9/32	1	1/8	YES	60518H-100F	
	5xD	3-15/16	5-17/64	5-25/64	7-35/64	2-9/32	1	1/8	NO	60518H-100C	
	7xD	5-33/64	6-27/32	6-61/64	9-1/8	2-9/32	1	1/8	YES	60718H-100F	
	7xD	5-33/64	6-27/32	6-61/64	9-1/8	2-9/32	1	1/8	NO	60718H-100C	
	3xD	60.0	94.0	96.8	150.0	56.0	25.0	1/8*	YES	60318S-25FM	
	5xD	100.0	133.7	136.8	189.7	56.0	25.0	1/8*	YES	60518S-25FM	
	7xD	140.0	173.4	176.8	229.4	56.0	25.0	1/8*	YES	60718S-25FM	
	Stub	22.0	56.0	58.8	112.0	56.0	25.0	1/8*	YES	60118H-25FM	
	3xD	60.0	94.0	96.8	150.0	56.0	25.0	1/8*	YES	60318H-25FM	
	3xD	60.0	94.0	96.8	150.0	56.0	25.0	1/8*	NO	60318H-25CM	
	5xD	100.0	133.7	136.8	189.7	56.0	25.0	1/8*	YES	60518H-25FM	
	5xD	100.0	133.7	136.8	189.7	56.0	25.0	1/8*	NO	60518H-25CM	
	7xD	140.0	173.4	176.8	229.4	56.0	25.0	1/8*	YES	60718H-25FM	
	7xD	140.0	173.4	176.8	229.4	56.0	25.0	1/8*	NO	60718H-25CM	

*Thread to BSP and ISO 7-1

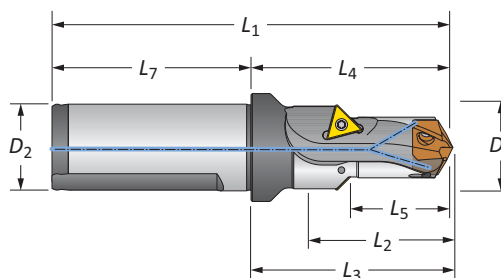

Drill / Chamfer

Step	Body				Shank		Part No.	Chamfer Insert		
	D ₅	L ₅	L ₂	L ₄	L ₃	L ₁			L ₇	D ₂
	63/64	1-1/16	1-25/64	2-13/64	2-5/16	4-31/64	2-9/32	1	60118C45-100F	TCMT-110204
	25.1	27	35.2	56.0	58.8	112.0	56.0	25.0	60118C45-25FM	TCMT-110204

Connection Accessories

					Admissible Tightening Torque*
7375-IP9-1	7375N-IP9-1	8IP-9	8IP-9TL	8IP-9B	27.0 in-lbs (305 N-cm)

*Tightening torques are calculated with a friction coefficient of $\mu = 0.14$ and develop 90% of ultimate yield strength



Chamfer inserts sold separately in multiples of 10 | Screws sold in multiples of 10

= Imperial (in)
 = Metric (mm)

GEN3SYS XT Pro Drill Inserts

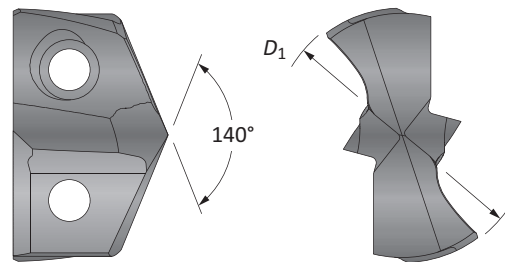
20 Series | Diameter Range: 0.7874" - 0.8660" (20.00 mm - 21.99 mm)



Fractional Equivalent	Insert				
	D_1 inch	D_1 mm	Part No. P	Part No. K	Part No. N
-	0.7874	20.00	XTP20-20.00	XTK20-20.00	XTN20-20.00
-	0.7913	20.10	XTP20-20.10	XTK20-20.10	XTN20-20.10
-	0.7953	20.20	XTP20-20.20	XTK20-20.20	XTN20-20.20
51/64	0.7969	20.24	XTP20-20.24	XTK20-20.24	XTN20-20.24
-	0.7992	20.30	XTP20-20.30	XTK20-20.30	XTN20-20.30
-	0.8031	20.40	XTP20-20.40	XTK20-20.40	XTN20-20.40
-	0.8071	20.50	XTP20-20.50	XTK20-20.50	XTN20-20.50
-	0.8110	20.60	XTP20-20.60	XTK20-20.60	XTN20-20.60
13/16	0.8126	20.64	XTP20-20.64	XTK20-20.64	XTN20-20.64
-	0.8150	20.70	XTP20-20.70	XTK20-20.70	XTN20-20.70
-	0.8189	20.80	XTP20-20.80	XTK20-20.80	XTN20-20.80
-	0.8228	20.90	XTP20-20.90	XTK20-20.90	XTN20-20.90
-	0.8268	21.00	XTP20-21.00	XTK20-21.00	XTN20-21.00
-	0.8307	21.10	XTP20-21.10	XTK20-21.10	XTN20-21.10
-	0.8346	21.20	XTP20-21.20	XTK20-21.20	XTN20-21.20
-	0.8386	21.30	XTP20-21.30	XTK20-21.30	XTN20-21.30
-	0.8425	21.40	XTP20-21.40	XTK20-21.40	XTN20-21.40
27/32	0.8437	21.43	XTP20-21.43	XTK20-21.43	XTN20-21.43
-	0.8465	21.50	XTP20-21.50	XTK20-21.50	XTN20-21.50
-	0.8504	21.60	XTP20-21.60	XTK20-21.60	XTN20-21.60
-	0.8543	21.70	XTP20-21.70	XTK20-21.70	XTN20-21.70
-	0.8583	21.80	XTP20-21.80	XTK20-21.80	XTN20-21.80
55/64	0.8594	21.83	XTP20-21.83	XTK20-21.83	XTN20-21.83
-	0.8622	21.90	XTP20-21.90	XTK20-21.90	XTN20-21.90

Inserts sold in multiples of 1

A20: 68 - 83

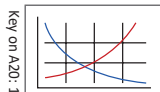

A20: 6 - 9



Sizes not shown are available upon request.

When ordering, please follow the example below:

Imperial:	0.5180", Steel, 13 series = use Part No. XTP13-13.16
Metric:	13.16 mm, Steel, 13 series = use Part No. XTP13-13.16



GEN3SYS XT Pro Drill Insert Holders

20 Series | Diameter Range: 0.7874" - 0.8660" (20.00 mm - 21.99 mm)

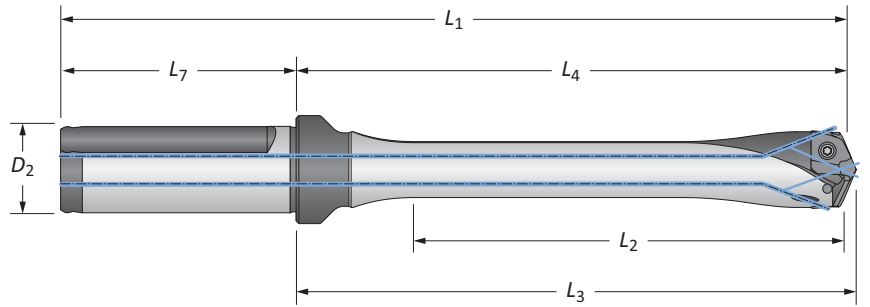

Flute	Body					Shank			Part No.
	Length	L ₂	L ₄	L ₃	L ₁	L ₇	D ₂	Flat	
i Straight	3xD	2-19/32	3-15/16	4-3/64	6-7/32	2-9/32	1	YES	HXT0320S-100F
	3xD	2-19/32	3-15/16	4-3/64	6-7/32	2-9/32	1	NO	HXT0320S-100C
	5xD	4-21/64	5-43/64	5-25/32	7-61/64	2-9/32	1	YES	HXT0520S-100F
	5xD	4-21/64	5-43/64	5-25/32	7-61/64	2-9/32	1	NO	HXT0520S-100C
	7xD	6-1/16	7-13/32	7-33/64	9-11/16	2-9/32	1	YES	HXT0720S-100F
	7xD	6-1/16	7-13/32	7-33/64	9-11/16	2-9/32	1	NO	HXT0720S-100C
	10xD	8-21/32	10	10-7/64	12-9/32	2-9/32	1	YES	HXT1020S-100F
	10xD	8-21/32	10	10-7/64	12-9/32	2-9/32	1	NO	HXT1020S-100C
	12xD	10-25/64	11-47/64	11-27/32	14-1/64	2-9/32	1	YES	HXT1220S-100F
12xD	10-25/64	11-47/64	11-27/32	14-1/64	2-9/32	1	NO	HXT1220S-100C	
m Straight	3xD	66.0	100.0	102.9	156.0	56.0	25.0	YES	HXT0320S-25FM
	3xD	66.0	100.0	102.9	156.0	56.0	25.0	NO	HXT0320S-25CM
	5xD	110.0	144.0	146.9	200.0	56.0	25.0	YES	HXT0520S-25FM
	5xD	110.0	144.0	146.9	200.0	56.0	25.0	NO	HXT0520S-25CM
	7xD	153.9	187.0	190.9	243.0	56.0	25.0	YES	HXT0720S-25FM
	7xD	153.9	187.0	190.9	243.0	56.0	25.0	NO	HXT0720S-25CM
	10xD	219.9	254.0	256.8	310.0	56.0	25.0	YES	HXT1020S-25FM
	10xD	219.9	254.0	256.8	310.0	56.0	25.0	NO	HXT1020S-25CM
	12xD	264.0	298.0	300.8	354.0	56.0	25.0	YES	HXT1220S-25FM
12xD	264.0	298.0	300.8	354.0	56.0	25.0	NO	HXT1220S-25CM	

Connection Accessories

					Admissible Tightening Torque*
7375-IP9-1	7375N-IP9-1	8IP-9	8IP-9TL	8IP-9B	27.0 in-lbs (305 N-cm)

*Tightening torques are calculated with a friction coefficient of $\mu = 0.14$ and develop 90% of ultimate yield strength

⚠ WARNING Refer to Speed and Feed charts for recommended adjustments to speeds and feeds. Refer to page A20: 86 for deep hole drilling guidelines in this section of the catalog. Visit www.alliedmachine.com/DeepHoleGuidelines for the most up-to-date information and procedures. Factory technical assistance is available for your specific applications through our Application Engineering Team. ext: 7611 | email: appeng@alliedmachine.com

i = Imperial (in)
m = Metric (mm)

Screws sold in multiples of 10

A DRILLING
B BORING
C REAMING
D BURNISHING
E THREADING
X SPECIALS



GEN3SYS XT Drill Inserts

20 Series | Diameter Range: 0.7874" - 0.8660" (20.00 mm - 21.99 mm)

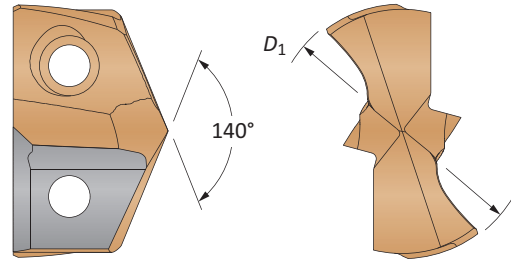

Carbide Substrate	Insert			Standard Part No.	Low Rake Part No.	Cast Iron Part No.	Stainless Part No.
	Fractional Equivalent	D ₁ inch	D ₁ mm				
C1 (K35)	-	0.7874	20.00	7C120P-20	7C120P-20LR	-	-
	51/64	0.7969	20.24	7C120P-.796	7C120P-.796LR	-	-
	-	0.8071	20.50	7C120P-20.5	7C120P-20.5LR	-	-
	13/16	0.8125	20.64	7C120P-0026	7C120P-0026LR	-	-
	-	0.8268	21.00	7C120P-21	7C120P-21LR	-	-
	27/32	0.8438	21.43	7C120P-0027	7C120P-0027LR	-	-
	-	0.8465	21.50	7C120P-21.5	7C120P-21.5LR	-	-
	55/64	0.8594	21.83	7C120P-.859	7C120P-.859LR	-	-
C2 (K20)	-	0.7874	20.00	7C220P-20	7C220P-20LR	7C220P-20CI	7C220P-20AS
	51/64	0.7969	20.24	7C220P-.796	7C220P-.796LR	7C220P-.796CI	7C220P-.796AS
	-	0.8071	20.50	7C220P-20.5	7C220P-20.5LR	7C220P-20.5CI	7C220P-20.5AS
	13/16	0.8125	20.64	7C220P-0026	7C220P-0026LR	7C220P-0026CI	7C220P-0026AS
	-	0.8268	21.00	7C220P-21	7C220P-21LR	7C220P-21CI	7C220P-21AS
	27/32	0.8438	21.43	7C220P-0027	7C220P-0027LR	7C220P-0027CI	7C220P-0027AS
	-	0.8465	21.50	7C220P-21.5	7C220P-21.5LR	7C220P-21.5CI	7C220P-21.5AS
	55/64	0.8594	21.83	7C220P-.859	7C220P-.859LR	7C220P-.859CI	7C220P-.859AS

Inserts sold in multiples of 1

A20: 68 - 83

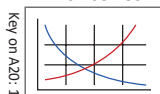

A20: 6 - 9



Key on A20: 1

Sizes not shown are available upon request.

When ordering, please follow the example below:

Imperial:	0.5200", 13 series, C2 = use Part No. 7C213P-.5200
Metric:	13.20 mm, 13 series, C2 = use Part No. 7C213P-13.20

GEN3SYS Drill Insert Holders

20 Series | Diameter Range: 0.7874" - 0.8660" (20.00 mm - 21.99 mm)

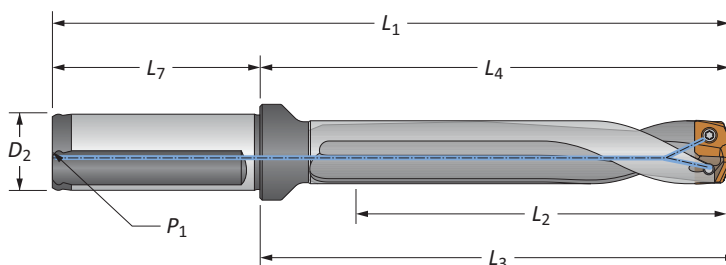

Straight and Helical

Flute	Length	Body				Shank				Flat	Part No.
		L ₂	L ₄	L ₃	L ₁	L ₇	D ₂	P ₁			
	3xD	2-19/32	3-15/16	4-3/64	6-7/32	2-9/32	1	1/8	YES	60320S-100F	
	5xD	4-21/64	5-43/64	5-25/32	7-61/64	2-9/32	1	1/8	YES	60520S-100F	
	7xD	6-1/16	7-13/32	7-33/64	9-11/16	2-9/32	1	1/8	YES	60720S-100F	
	Stub	15/16	2-17/64	2-3/8	4-35/64	2-9/32	1	1/8	YES	60120H-100F	
	3xD	2-19/32	3-15/16	4-3/64	6-7/32	2-9/32	1	1/8	YES	60320H-100F	
	3xD	2-19/32	3-15/16	4-3/64	6-7/32	2-9/32	1	1/8	NO	60320H-100C	
	5xD	4-21/64	5-43/64	5-25/32	7-61/64	2-9/32	1	1/8	YES	60520H-100F	
	5xD	4-21/64	5-43/64	5-25/32	7-61/64	2-9/32	1	1/8	NO	60520H-100C	
	7xD	6-1/16	7-13/32	7-33/64	9-11/16	2-9/32	1	1/8	YES	60720H-100F	
	7xD	6-1/16	7-13/32	7-33/64	9-11/16	2-9/32	1	1/8	NO	60720H-100C	
	7xD	6-1/16	7-13/32	7-33/64	9-11/16	2-9/32	1	1/8	NO	60720H-100C	
	3xD	66.0	100.0	102.9	156.0	56.0	25.0	1/8*	YES	60320S-25FM	
	5xD	110.0	144.0	146.9	200.0	56.0	25.0	1/8*	YES	60520S-25FM	
	7xD	153.9	187.0	190.9	243.0	56.0	25.0	1/8*	YES	60720S-25FM	
	Stub	24.0	57.6	60.4	113.6	56.0	25.0	1/8*	YES	60120H-25FM	
	3xD	66.0	100.0	102.9	156.0	56.0	25.0	1/8*	YES	60320H-25FM	
	3xD	66.0	100.0	102.9	156.0	56.0	25.0	1/8*	NO	60320H-25CM	
	5xD	110.0	144.0	146.9	200.0	56.0	25.0	1/8*	YES	60520H-25FM	
	5xD	110.0	144.0	146.9	200.0	56.0	25.0	1/8*	NO	60520H-25CM	
	7xD	153.9	187.0	190.9	243.0	56.0	25.0	1/8*	YES	60720H-25FM	
	7xD	153.9	187.0	190.9	243.0	56.0	25.0	1/8*	NO	60720H-25CM	

*Thread to BSP and ISO 7-1

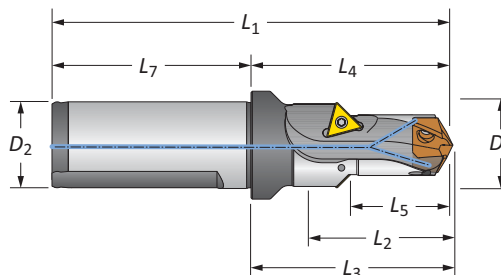

Drill / Chamfer

Step	Body				Shank			Part No.	Chamfer Insert	
	D ₅	L ₅	L ₂	L ₄	L ₃	L ₁	L ₇			D ₂
	1-5/64	1-3/16	1-29/64	2-17/64	2-3/8	4-35/64	2-9/32	1	60120C45-100F	TCMT-110204
	27.2	30.0	37.1	57.6	60.4	113.6	56.0	25.0	60120C45-25FM	TCMT-110204

Connection Accessories

Insert Screws	Nylon Locking Screws	Insert Driver	Preset Torque Hand Driver	Replacement Tips	Admissible Tightening Torque*
7375-IP9-1	7375N-IP9-1	8IP-9	8IP-9TL	8IP-9B	27.0 in-lbs (305 N-cm)

*Tightening torques are calculated with a friction coefficient of $\mu = 0.14$ and develop 90% of ultimate yield strength



Chamfer inserts sold separately in multiples of 10 | Screws sold in multiples of 10

= Imperial (in)
 = Metric (mm)

GEN3SYS XT Pro Drill Inserts

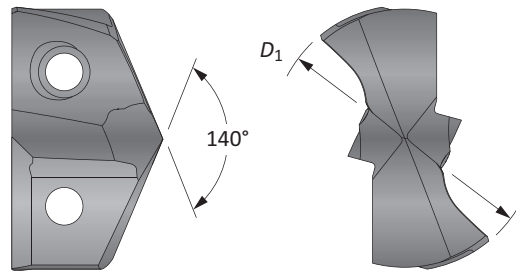
22 Series | Diameter Range: 0.8661" - 0.9448" (22.00 mm - 23.99 mm)



Fractional Equivalent	Insert				
	D_1 inch	D_1 mm	Part No. P	Part No. K	Part No. N
-	0.8661	22.00	XTP22-22.00	XTK22-22.00	XTN22-22.00
-	0.8701	22.10	XTP22-22.10	XTK22-22.10	XTN22-22.10
-	0.8740	22.20	XTP22-22.20	XTK22-22.20	XTN22-22.20
7/8	0.8752	22.23	XTP22-22.23	XTK22-22.23	XTN22-22.23
-	0.8780	22.30	XTP22-22.30	XTK22-22.30	XTN22-22.30
-	0.8819	22.40	XTP22-22.40	XTK22-22.40	XTN22-22.40
-	0.8858	22.50	XTP22-22.50	XTK22-22.50	XTN22-22.50
57/64	0.8906	22.62	XTP22-22.62	XTK22-22.62	XTN22-22.62
-	0.8937	22.70	XTP22-22.70	XTK22-22.70	XTN22-22.70
-	0.8976	22.80	XTP22-22.80	XTK22-22.80	XTN22-22.80
-	0.9016	22.90	XTP22-22.90	XTK22-22.90	XTN22-22.90
-	0.9055	23.00	XTP22-23.00	XTK22-23.00	XTN22-23.00
29/32	0.9063	23.02	XTP22-23.02	XTK22-23.02	XTN22-23.02
-	0.9094	23.10	XTP22-23.10	XTK22-23.10	XTN22-23.10
-	0.9134	23.20	XTP22-23.20	XTK22-23.20	XTN22-23.20
-	0.9173	23.30	XTP22-23.30	XTK22-23.30	XTN22-23.30
59/64	0.9220	23.42	XTP22-23.42	XTK22-23.42	XTN22-23.42
-	0.9252	23.50	XTP22-23.50	XTK22-23.50	XTN22-23.50
-	0.9291	23.60	XTP22-23.60	XTK22-23.60	XTN22-23.60
-	0.9331	23.70	XTP22-23.70	XTK22-23.70	XTN22-23.70
15/16	0.9374	23.81	XTP22-23.81	XTK22-23.81	XTN22-23.81
-	0.9409	23.90	XTP22-23.90	XTK22-23.90	XTN22-23.90

Inserts sold in multiples of 1

A20: 68 - 83

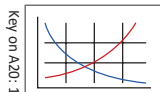

A20: 6 - 9



Key on A20: 1

Sizes not shown are available upon request.
When ordering, please follow the example below:

Imperial:	0.5180", Steel, 13 series = use Part No. XTP13-13.16
Metric:	13.16 mm, Steel, 13 series = use Part No. XTP13-13.16

GEN3SYS XT Pro Drill Insert Holders

22 Series | Diameter Range: 0.8661" - 0.9448" (22.00 mm - 23.99 mm)

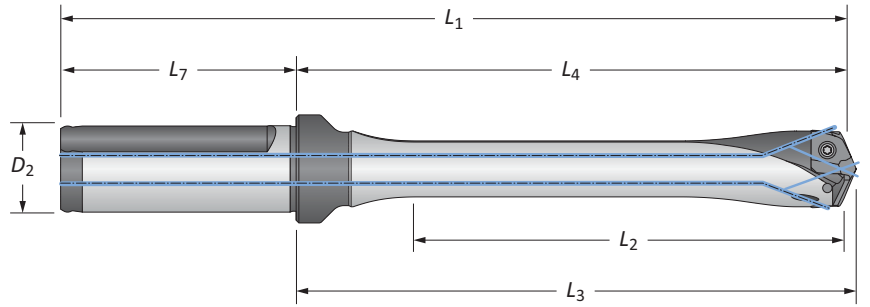

Flute	Body					Shank			Part No.
	Length	L ₂	L ₄	L ₃	L ₁	L ₇	D ₂	Flat	
i Straight	3xD	2-53/64	4-9/64	4-17/64	6-27/64	2-9/32	1	YES	HXT0322S-100F
	3xD	2-53/64	4-9/64	4-17/64	6-27/64	2-9/32	1	NO	HXT0322S-100C
	5xD	4-23/32	6-1/32	6-5/32	8-5/16	2-9/32	1	YES	HXT0522S-100F
	5xD	4-23/32	6-1/32	6-5/32	8-5/16	2-9/32	1	NO	HXT0522S-100C
	7xD	6-39/64	7-59/64	8-3/64	10-13/64	2-9/32	1	YES	HXT0722S-100F
	7xD	6-39/64	7-59/64	8-3/64	10-13/64	2-9/32	1	NO	HXT0722S-100C
	10xD	9-7/16	10-3/4	10-7/8	13-1/32	2-9/32	1	YES	HXT1022S-100F
	10xD	9-7/16	10-3/4	10-7/8	13-1/32	2-9/32	1	NO	HXT1022S-100C
	12xD	11-11/32	12-41/64	12-3/4	14-59/64	2-9/32	1	YES	HXT1222S-100F
12xD	11-11/32	12-41/64	12-3/4	14-59/64	2-9/32	1	NO	HXT1222S-100C	
m Straight	3xD	72.0	105.1	108.3	161.1	56.0	25.0	YES	HXT0322S-25FM
	3xD	72.0	105.1	108.3	161.1	56.0	25.0	NO	HXT0322S-25CM
	5xD	120.0	153.2	156.2	209.2	56.0	25.0	YES	HXT0522S-25FM
	5xD	120.0	153.2	156.2	209.2	56.0	25.0	NO	HXT0522S-25CM
	7xD	167.9	201.2	204.2	257.2	56.0	25.0	YES	HXT0722S-25FM
	7xD	167.9	201.2	204.2	257.2	56.0	25.0	NO	HXT0722S-25CM
	10xD	239.9	273.0	276.2	329.0	56.0	25.0	YES	HXT1022S-25FM
	10xD	239.9	273.0	276.2	329.0	56.0	25.0	NO	HXT1022S-25CM
	12xD	288.0	321.2	324.2	377.2	56.0	25.0	YES	HXT1222S-25FM
12xD	288.0	321.2	324.2	377.2	56.0	25.0	NO	HXT1222S-25CM	

Connection Accessories

					Admissible Tightening Torque*
739-IP9-1	739N-IP9-1	8IP-9	8IP-9TL	8IP-9B	27.0 in-lbs (305 N-cm)

*Tightening torques are calculated with a friction coefficient of $\mu = 0.14$ and develop 90% of ultimate yield strength

⚠ WARNING Refer to Speed and Feed charts for recommended adjustments to speeds and feeds. Refer to page A20: 86 for deep hole drilling guidelines in this section of the catalog. Visit www.alliedmachine.com/DeepHoleGuidelines for the most up-to-date information and procedures. Factory technical assistance is available for your specific applications through our Application Engineering Team. ext: 7611 | email: appeng@alliedmachine.com

i = Imperial (in)
m = Metric (mm)

Screws sold in multiples of 10

A DRILLING
B BORING
C REAMING
D BURNISHING
E THREADING
X SPECIALS

GEN3SYS XT Drill Inserts

22 Series | Diameter Range: 0.8661" - 0.9448" (22.00 mm - 23.99 mm)

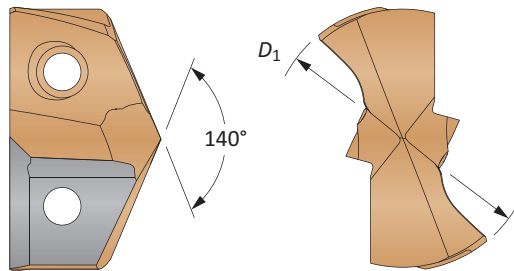
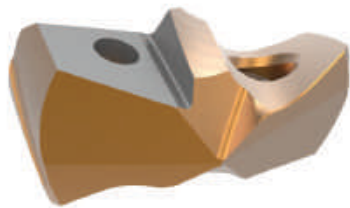

Carbide Substrate	Insert			Standard Part No.	Low Rake Part No.	Cast Iron Part No.	Stainless Part No.
	Fractional Equivalent	D_1 inch	D_1 mm				
C1 (K35)		0.8661	22.00	7C122P-22	7C122P-22LR	-	-
	7/8	0.8750	22.23	7C122P-0028	7C122P-0028LR	-	-
	57/64	0.8906	22.61	7C122P-.890	7C122P-.890LR	-	-
		0.9055	23.00	7C122P-23	7C122P-23LR	-	-
	29/32	0.9063	23.02	7C122P-0029	7C122P-0029LR	-	-
	59/64	0.9219	23.42	7C122P-.921	7C122P-.921LR	-	-
	15/16	0.9375	23.81	7C122P-0030	7C122P-0030LR	-	-
C2 (K20)		0.8661	22.00	7C222P-22	7C222P-22LR	7C222P-22CI	7C222P-22AS
	7/8	0.8750	22.23	7C222P-0028	7C222P-0028LR	7C222P-0028CI	7C222P-0028AS
	57/64	0.8906	22.61	7C222P-.890	7C222P-.890LR	7C222P-.890CI	7C222P-.890AS
		0.9055	23.00	7C222P-23	7C222P-23LR	7C222P-23CI	7C222P-23AS
	29/32	0.9063	23.02	7C222P-0029	7C222P-0029LR	7C222P-0029CI	7C222P-0029AS
	59/64	0.9219	23.42	7C222P-.921	7C222P-.921LR	7C222P-.921CI	7C222P-.921AS
	15/16	0.9375	23.81	7C222P-0030	7C222P-0030LR	7C222P-0030CI	7C222P-0030AS

Inserts sold in multiples of 1

A20: 68 - 83

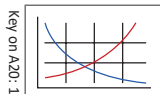

A20: 6 - 9



Key on A20: 1

Sizes not shown are available upon request.
When ordering, please follow the example below:

Imperial:	0.5200", 13 series, C2 = use Part No. 7C213P-.5200
Metric:	13.20 mm, 13 series, C2 = use Part No. 7C213P-13.20

GEN3SYS Drill Insert Holders

22 Series | Diameter Range: 0.8661" - 0.9448" (22.00 mm - 23.99 mm)

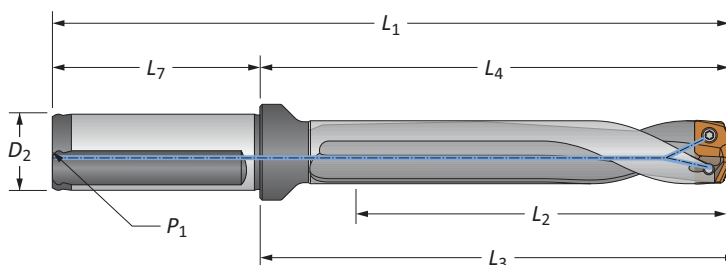

Straight and Helical

Flute	Length	Body				Shank				Flat	Part No.
		L ₂	L ₄	L ₃	L ₁	L ₇	D ₂	P ₁			
	3xD	2-53/64	4-9/64	4-17/64	6-27/64	2-9/32	1	1/8	YES	60322S-100F	
	5xD	4-23/32	6-1/32	6-5/32	8-5/16	2-9/32	1	1/8	YES	60522S-100F	
	7xD	6-39/64	7-59/64	8-3/64	10-13/64	2-9/32	1	1/8	YES	60722S-100F	
	Stub	1-1/16	2-23/64	2-31/64	4-41/64	2-9/32	1	1/8	YES	60122H-100F	
	3xD	2-53/64	4-9/64	4-17/64	6-27/64	2-9/32	1	1/8	YES	60322H-100F	
	3xD	2-53/64	4-9/64	4-17/64	6-27/64	2-9/32	1	1/8	NO	60322H-100C	
	5xD	4-23/32	6-1/32	6-5/32	8-5/16	2-9/32	1	1/8	YES	60522H-100F	
	5xD	4-23/32	6-1/32	6-5/32	8-5/16	2-9/32	1	1/8	NO	60522H-100C	
	7xD	6-39/64	7-59/64	8-3/64	10-13/64	2-9/32	1	1/8	YES	60722H-100F	
	7xD	6-39/64	7-59/64	8-3/64	10-13/64	2-9/32	1	1/8	NO	60722H-100C	
		3xD	72.0	105.1	108.3	161.1	56.0	25.0	1/8*	YES	60322S-25FM
5xD		120.0	153.2	156.2	209.2	56.0	25.0	1/8*	YES	60522S-25FM	
7xD		167.9	201.2	204.2	257.2	56.0	25.0	1/8*	YES	60722S-25FM	
Stub		27.0	60.1	63.0	116.1	56.0	25.0	1/8*	YES	60122H-25FM	
3xD		72.0	105.1	108.3	161.1	56.0	25.0	1/8*	YES	60322H-25FM	
3xD		72.0	105.1	108.3	161.1	56.0	25.0	1/8*	NO	60322H-25CM	
5xD		120.0	153.2	156.2	209.2	56.0	25.0	1/8*	YES	60522H-25FM	
5xD		120.0	153.2	156.2	209.2	56.0	25.0	1/8*	NO	60522H-25CM	
7xD		167.9	201.2	204.2	257.2	56.0	25.0	1/8*	YES	60722H-25FM	
7xD		167.9	201.2	204.2	257.2	56.0	25.0	1/8*	NO	60722H-25CM	

*Thread to BSP and ISO 7-1

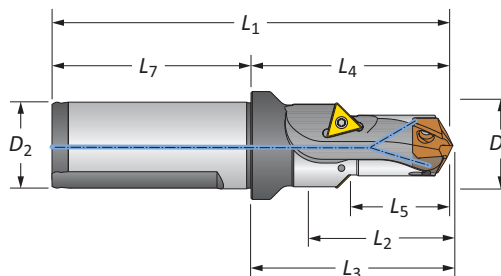

Drill / Chamfer

Step	Body				Shank			Part No.	Chamfer Insert	
	D ₅	L ₅	L ₂	L ₄	L ₃	L ₁	L ₇			D ₂
	1-9/64	1-19/64	1-19/32	2-23/64	2-31/64	4-41/64	2-9/32	1	60122C45-100F	TCMT-110204
	29.0	33.0	40.5	60.0	63.0	116.0	56.0	25.0	60122C45-25FM	TCMT-110204

Connection Accessories

Insert Screws	Nylon Locking Screws	Insert Driver	Preset Torque Hand Driver	Replacement Tips	Admissible Tightening Torque*
739-IP9-1	739N-IP9-1	8IP-9	8IP-9TL	8IP-9B	27.0 in-lbs (305 N-cm)

*Tightening torques are calculated with a friction coefficient of $\mu = 0.14$ and develop 90% of ultimate yield strength



Chamfer inserts sold separately in multiples of 10 | Screws sold in multiples of 10

= Imperial (in)
 = Metric (mm)

GEN3SYS XT Pro Drill Inserts

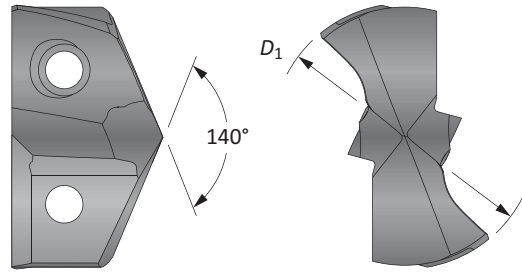
24 Series | Diameter Range: 0.9449" - 1.0235" (24.00 mm - 25.99 mm)



Fractional Equivalent	Insert				
	D_1 inch	D_1 mm	Part No. P	Part No. K	Part No. N
-	0.9449	24.00	XTP24-24.00	XTK24-24.00	XTN24-24.00
-	0.9488	24.10	XTP24-24.10	XTK24-24.10	XTN24-24.10
-	0.9528	24.20	XTP24-24.20	XTK24-24.20	XTN24-24.20
-	0.9567	24.30	XTP24-24.30	XTK24-24.30	XTN24-24.30
-	0.9606	24.40	XTP24-24.40	XTK24-24.40	XTN24-24.40
-	0.9646	24.50	XTP24-24.50	XTK24-24.50	XTN24-24.50
31/32	0.9689	24.61	XTP24-24.61	XTK24-24.61	XTN24-24.61
-	0.9724	24.70	XTP24-24.70	XTK24-24.70	XTN24-24.70
-	0.9764	24.80	XTP24-24.80	XTK24-24.80	XTN24-24.80
-	0.9803	24.90	XTP24-24.90	XTK24-24.90	XTN24-24.90
63/64	0.9843	25.00	XTP24-25.00	XTK24-25.00	XTN24-25.00
-	0.9882	25.10	XTP24-25.10	XTK24-25.10	XTN24-25.10
-	0.9921	25.20	XTP24-25.20	XTK24-25.20	XTN24-25.20
-	0.9961	25.30	XTP24-25.30	XTK24-25.30	XTN24-25.30
1	1.0000	25.40	XTP24-25.40	XTK24-25.40	XTN24-25.40
-	1.0039	25.50	XTP24-25.50	XTK24-25.50	XTN24-25.50
-	1.0079	25.60	XTP24-25.60	XTK24-25.60	XTN24-25.60
-	1.0118	25.70	XTP24-25.70	XTK24-25.70	XTN24-25.70
1-1/64	1.0150	25.78	XTP24-25.78	XTK24-25.78	XTN24-25.78
-	1.0197	25.90	XTP24-25.90	XTK24-25.90	XTN24-25.90

Inserts sold in multiples of 1

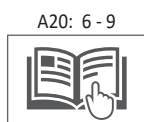
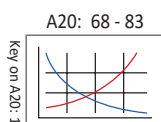

Sizes not shown are available upon request.	
When ordering, please follow the example below:	
Imperial:	0.5180", Steel, 13 series = use Part No. XTP13-13.16
Metric:	13.16 mm, Steel, 13 series = use Part No. XTP13-13.16

GEN3SYS XT Pro Drill Insert Holders

24 Series | Diameter Range: 0.9449" - 1.0235" (24.00 mm - 25.99 mm)

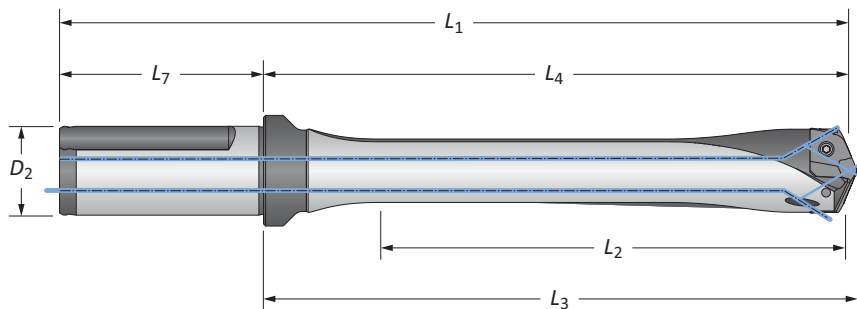

Flute	Body					Shank			Part No.
	Length	L ₂	L ₄	L ₃	L ₁	L ₇	D ₂	Flat	
i Straight	3xD	3-1/16	4-31/64	4-19/32	6-49/64	2-9/32	1	YES	HXT0324S-100F
	3xD	3-1/16	4-31/64	4-19/32	6-49/64	2-9/32	1	NO	HXT0324S-100C
	5xD	5-7/64	6-17/32	6-41/64	8-13/16	2-9/32	1	YES	HXT0524S-100F
	5xD	5-7/64	6-17/32	6-41/64	8-13/16	2-9/32	1	NO	HXT0524S-100C
	7xD	7-5/32	8-37/64	8-11/16	10-55/64	2-9/32	1	YES	HXT0724S-100F
	7xD	7-5/32	8-37/64	8-11/16	10-55/64	2-9/32	1	NO	HXT0724S-100C
	10xD	10-15/64	11-41/64	11-49/64	13-59/64	2-9/32	1	YES	HXT1024S-100F
	10xD	10-15/64	11-41/64	11-49/64	13-59/64	2-9/32	1	NO	HXT1024S-100C
	12xD	12-9/32	13-11/16	13-51/64	15-31/32	2-9/32	1	YES	HXT1224S-100F
12xD	12-9/32	13-11/16	13-15/64	15-31/32	2-9/32	1	NO	HXT1224S-100C	
m Straight	3xD	78.0	113.9	116.8	169.9	56.0	25.0	YES	HXT0324S-25FM
	3xD	78.0	113.9	116.8	169.9	56.0	25.0	NO	HXT0324S-25CM
	5xD	130.0	165.9	168.7	221.9	56.0	25.0	YES	HXT0524S-25FM
	5xD	130.0	165.9	168.7	221.9	56.0	25.0	NO	HXT0524S-25CM
	7xD	181.9	217.9	220.7	273.9	56.0	25.0	YES	HXT0724S-25FM
	7xD	181.9	217.9	220.7	273.9	56.0	25.0	NO	HXT0724S-25CM
	10xD	259.9	295.7	298.7	351.7	56.0	25.0	YES	HXT1024S-25FM
	10xD	259.9	295.7	298.7	351.7	56.0	25.0	NO	HXT1024S-25CM
	12xD	312.0	347.7	350.7	403.7	56.0	25.0	YES	HXT1224S-25FM
12xD	312.0	347.7	350.7	403.7	56.0	25.0	NO	HXT1224S-25CM	

Connection Accessories

					Admissible Tightening Torque*
739-IP9-1	739N-IP9-1	8IP-9	8IP-9TL	8IP-9B	27.0 in-lbs (305 N-cm)

*Tightening torques are calculated with a friction coefficient of $\mu = 0.14$ and develop 90% of ultimate yield strength

⚠ WARNING Refer to Speed and Feed charts for recommended adjustments to speeds and feeds. Refer to page A20: 86 for deep hole drilling guidelines in this section of the catalog. Visit www.alliedmachine.com/DeepHoleGuidelines for the most up-to-date information and procedures. Factory technical assistance is available for your specific applications through our Application Engineering Team. ext: 7611 | email: appeng@alliedmachine.com

i = Imperial (in)
m = Metric (mm)

Screws sold in multiples of 10



GEN3SYS XT Drill Inserts

24 Series | Diameter Range: 0.9449" - 1.0235" (24.00 mm - 25.99 mm)

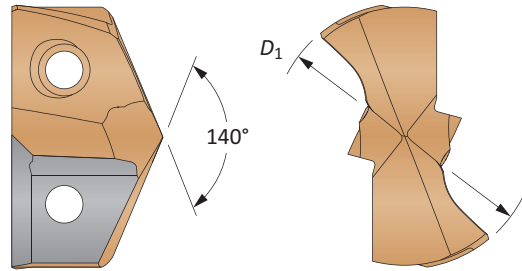
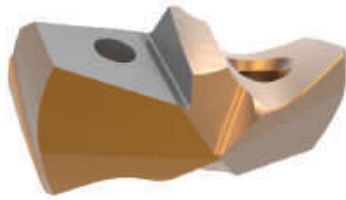

Carbide Substrate	Insert			Standard Part No.	Low Rake Part No.	Cast Iron Part No.	Stainless Part No.
	Fractional Equivalent	D_1 inch	D_1 mm				
C1 (K35)	-	0.9449	24.00	7C124P-24	7C124P-24LR	-	-
	31/32	0.9688	24.61	7C124P-0031	7C124P-0031LR	-	-
	63/64	0.9843	25.00	7C124P-25	7C124P-25LR	-	-
	1	1.0000	25.40	7C124P-0100	7C124P-0100LR	-	-
	-	1.0080	25.60	7C124P-1.008	7C124P-1.008LR	-	-
	1-1/64	1.0156	25.78	7C124P-1.015	7C124P-1.015LR	-	-
C2 (K20)	-	0.9449	24.00	7C224P-24	7C224P-24LR	7C224P-24CI	7C224P-24AS
	31/32	0.9688	24.61	7C224P-0031	7C224P-0031LR	7C224P-0031CI	7C224P-0031AS
	63/64	0.9843	25.00	7C224P-25	7C224P-25LR	7C224P-25CI	7C224P-25AS
	1	1.0000	25.40	7C224P-0100	7C224P-0100LR	7C224P-0100CI	7C224P-0100AS
	-	1.0080	25.60	7C224P-1.008	7C224P-1.008LR	7C224P-1.008CI	7C224P-1.008AS
	1-1/64	1.0156	25.78	7C224P-1.015	7C224P-1.015LR	7C224P-1.015CI	7C224P-1.015AS

Inserts sold in multiples of 1

A20: 68 - 83

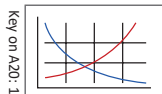

A20: 6 - 9



Sizes not shown are available upon request.
When ordering, please follow the example below:

Imperial:	0.5200", 13 series, C2 = use Part No. 7C213P-.5200
Metric:	13.20 mm, 13 series, C2 = use Part No. 7C213P-13.20

GEN3SYS Drill Insert Holders

24 Series | Diameter Range: 0.9449" - 1.0235" (24.00 mm - 25.99 mm)

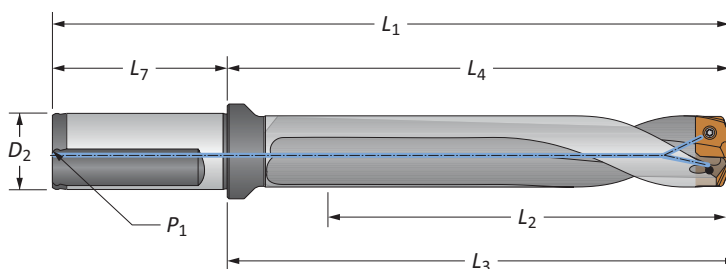

Straight and Helical

Flute	Length	Body				Shank				Part No.
		L ₂	L ₄	L ₃	L ₁	L ₇	D ₂	P ₁	Flat	
	3xD	3-1/16	4-31/64	4-19/32	6-49/64	2-9/32	1	1/8	YES	60324S-100F
	5xD	5-7/64	6-17/32	6-41/64	8-13/16	2-9/32	1	1/8	YES	60524S-100F
	7xD	7-5/32	8-37/64	8-11/16	10-55/64	2-9/32	1	1/8	YES	60724S-100F
	Stub	1-1/8	2-17/32	2-41/64	4-13/16	2-9/32	1	1/8	YES	60124H-100F
	3xD	3-1/16	4-31/64	4-19/32	6-49/64	2-9/32	1	1/8	YES	60324H-100F
	3xD	3-1/16	4-31/64	4-19/32	6-49/64	2-9/32	1	1/8	NO	60324H-100C
	5xD	5-7/64	6-17/32	6-41/64	8-13/16	2-9/32	1	1/8	YES	60524H-100F
	5xD	5-7/64	6-17/32	6-41/64	8-13/16	2-9/32	1	1/8	NO	60524H-100C
	7xD	7-5/32	8-37/64	8-11/16	10-55/64	2-9/32	1	1/8	YES	60724H-100F
	7xD	7-5/32	8-37/64	8-11/16	10-55/64	2-9/32	1	1/8	NO	60724H-100C
	3xD	78.0	113.9	116.8	169.9	56.0	25.0	1/8*	YES	60324S-25FM
	5xD	130.0	165.9	168.7	221.9	56.0	25.0	1/8*	YES	60524S-25FM
	7xD	181.9	217.9	220.7	273.9	56.0	25.0	1/8*	YES	60724S-25FM
	Stub	28.5	64.2	67.1	120.1	56.0	25.0	1/8*	YES	60124H-25FM
	3xD	78.0	113.9	116.8	169.9	56.0	25.0	1/8*	YES	60324H-25FM
	3xD	78.0	113.9	116.8	169.9	56.0	25.0	1/8*	NO	60324H-25CM
	5xD	130.0	165.9	168.7	221.9	56.0	25.0	1/8*	YES	60524H-25FM
	5xD	130.0	165.9	168.7	221.9	56.0	25.0	1/8*	NO	60524H-25CM
	7xD	181.9	217.9	220.7	273.9	56.0	25.0	1/8*	YES	60724H-25FM
	7xD	181.9	217.9	220.7	273.9	56.0	25.0	1/8*	NO	60724H-25CM

*Thread to BSP and ISO 7-1

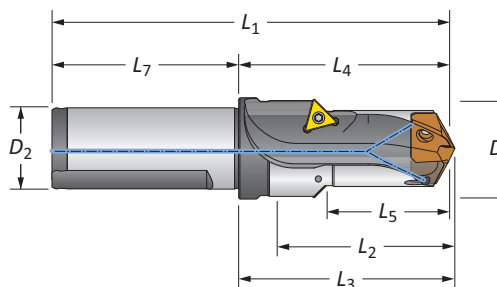

Drill / Chamfer

Step	Body				Shank		Part No.	Chamfer Insert		
	D ₅	L ₅	L ₂	L ₄	L ₃	L ₁			L ₇	D ₂
	1-7/32	1-27/64	1-51/64	2-17/32	2-41/64	4-13/16	2-9/32	1	60124C45-100F	TCMT-110204
	31.0	36.0	45.5	64.2	67.1	120.2	56.0	25.0	60124C45-25FM	TCMT-110204

Connection Accessories

Insert Screws	Nylon Locking Screws	Insert Driver	Preset Torque Hand Driver	Replacement Tips	Admissible Tightening Torque*
739-IP9-1	739N-IP9-1	8IP-9	8IP-9TL	8IP-9B	27.0 in-lbs (305 N-cm)

*Tightening torques are calculated with a friction coefficient of $\mu = 0.14$ and develop 90% of ultimate yield strength



Chamfer inserts sold separately in multiples of 10 | Screws sold in multiples of 10

= Imperial (in)
 = Metric (mm)

GEN3SYS XT Pro Drill Inserts

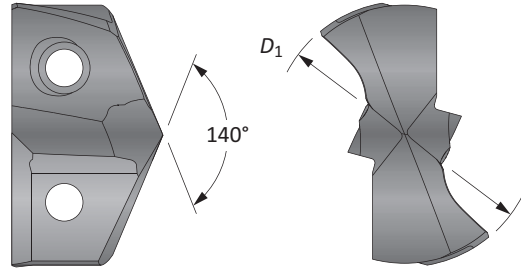
26 Series | Diameter Range: 1.0236" - 1.1416" (26.00 mm - 28.99 mm)



Fractional Equivalent	Insert				
	D ₁ inch	D ₁ mm	Part No. P	Part No. K	Part No. N
-	1.0236	26.00	XTP26-26.00	XTK26-26.00	XTN26-26.00
-	1.0276	26.10	XTP26-26.10	XTK26-26.10	XTN26-26.10
1-1/32	1.0315	26.20	XTP26-26.20	XTK26-26.20	XTN26-26.20
-	1.0354	26.30	XTP26-26.30	XTK26-26.30	XTN26-26.30
-	1.0394	26.40	XTP26-26.40	XTK26-26.40	XTN26-26.40
-	1.0433	26.50	XTP26-26.50	XTK26-26.50	XTN26-26.50
1-3/64	1.0469	26.59	XTP26-26.59	XTK26-26.59	XTN26-26.59
-	1.0472	26.60	XTP26-26.60	XTK26-26.60	XTN26-26.60
-	1.0512	26.70	XTP26-26.70	XTK26-26.70	XTN26-26.70
-	1.0551	26.80	XTP26-26.80	XTK26-26.80	XTN26-26.80
-	1.0591	26.90	XTP26-26.90	XTK26-26.90	XTN26-26.90
1-1/16	1.0626	26.99	XTP26-26.99	XTK26-26.99	XTN26-26.99
-	1.0630	27.00	XTP26-27.00	XTK26-27.00	XTN26-27.00
-	1.0669	27.10	XTP26-27.10	XTK26-27.10	XTN26-27.10
-	1.0709	27.20	XTP26-27.20	XTK26-27.20	XTN26-27.20
-	1.0748	27.30	XTP26-27.30	XTK26-27.30	XTN26-27.30
-	1.0787	27.40	XTP26-27.40	XTK26-27.40	XTN26-27.40
-	1.0827	27.50	XTP26-27.50	XTK26-27.50	XTN26-27.50
-	1.0866	27.60	XTP26-27.60	XTK26-27.60	XTN26-27.60
-	1.0906	27.70	XTP26-27.70	XTK26-27.70	XTN26-27.70
1-3/32	1.0937	27.78	XTP26-27.78	XTK26-27.78	XTN26-27.78
-	1.0984	27.90	XTP26-27.90	XTK26-27.90	XTN26-27.90
-	1.1024	28.00	XTP26-28.00	XTK26-28.00	XTN26-28.00
-	1.1063	28.10	XTP26-28.10	XTK26-28.10	XTN26-28.10
1-7/64	1.1091	28.17	XTP26-28.17	XTK26-28.17	XTN26-28.17
-	1.1102	28.20	XTP26-28.20	XTK26-28.20	XTN26-28.20
-	1.1142	28.30	XTP26-28.30	XTK26-28.30	XTN26-28.30
-	1.1181	28.40	XTP26-28.40	XTK26-28.40	XTN26-28.40
-	1.1220	28.50	XTP26-28.50	XTK26-28.50	XTN26-28.50
1-1/8	1.1252	28.58	XTP26-28.58	XTK26-28.58	XTN26-28.58
-	1.1299	28.70	XTP26-28.70	XTK26-28.70	XTN26-28.70
-	1.1339	28.80	XTP26-28.80	XTK26-28.80	XTN26-28.80
-	1.1378	28.90	XTP26-28.90	XTK26-28.90	XTN26-28.90

Inserts sold in multiples of 1

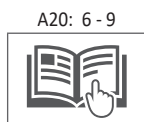
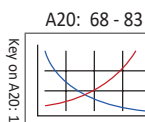

Sizes not shown are available upon request.	
When ordering, please follow the example below:	
Imperial:	0.5180", Steel, 13 series = use Part No. XTP13-13.16
Metric:	13.16 mm, Steel, 13 series = use Part No. XTP13-13.16

GEN3SYS XT Pro Drill Insert Holders

26 Series | Diameter Range: 1.0236" - 1.1416" (26.00 mm - 28.99 mm)

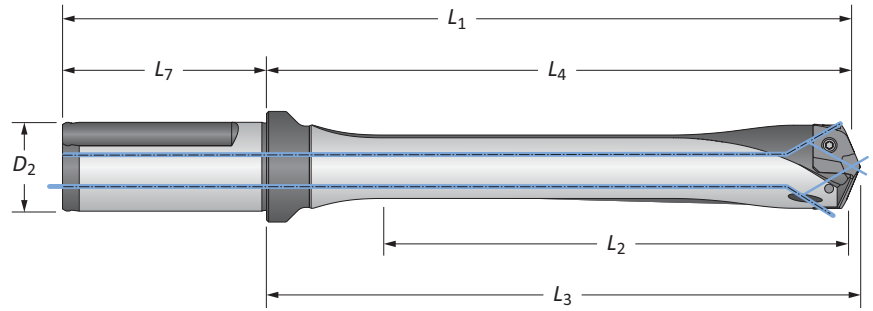

Flute	Body					Shank			Part No.
	Length	L ₂	L ₄	L ₃	L ₁	L ₇	D ₂	Flat	
i Straight	3xD	3-27/64	5-1/16	5-11/64	7-11/32	2-9/32	1-1/4	YES	HXT0326S-125F
	3xD	3-27/64	5-1/16	5-11/64	7-11/32	2-9/32	1-1/4	NO	HXT0326S-125C
	5xD	5-45/64	7-11/32	7-29/64	9-5/8	2-9/32	1-1/4	YES	HXT0526S-125F
	5xD	5-45/64	7-11/32	7-29/64	9-5/8	2-9/32	1-1/4	NO	HXT0526S-125C
	7xD	7-63/64	9-5/8	9-47/64	11-29/32	2-9/32	1-1/4	YES	HXT0726S-125F
	7xD	7-63/64	9-5/8	9-47/64	11-29/32	2-9/32	1-1/4	NO	HXT0726S-125C
	10xD	11-13/32	13-3/64	13-11/64	15-21/64	2-9/32	1-1/4	YES	HXT1026S-125F
	10xD	11-13/32	13-3/64	13-11/64	15-21/64	2-9/32	1-1/4	NO	HXT1026S-125C
	12xD	13-45/64	15-11/32	15-29/64	17-5/8	2-9/32	1-1/4	YES	HXT1226S-125F
12xD	13-45/64	15-11/32	15-29/64	17-5/8	2-9/32	1-1/4	NO	HXT1226S-125C	
m Straight	3xD	87.0	128.6	131.4	188.6	60.0	32.0	YES	HXT0326S-32FM
	3xD	87.0	128.6	131.4	188.6	60.0	32.0	NO	HXT0326S-32CM
	5xD	145.0	186.5	189.4	246.5	60.0	32.0	YES	HXT0526S-32FM
	5xD	145.0	186.5	189.4	246.5	60.0	32.0	NO	HXT0526S-32CM
	7xD	202.9	244.5	247.4	304.5	60.0	32.0	YES	HXT0726S-32FM
	7xD	202.9	244.5	247.4	304.5	60.0	32.0	NO	HXT0726S-32CM
	10xD	289.9	331.4	334.4	391.4	60.0	32.0	YES	HXT1026S-32FM
	10xD	289.9	331.4	334.4	391.4	60.0	32.0	NO	HXT1026S-32CM
	12xD	348.0	389.0	391.8	449.0	60.0	32.0	YES	HXT1226S-32FM
12xD	348.0	389.0	391.8	449.0	60.0	32.0	NO	HXT1226S-32CM	

Connection Accessories

					Admissible Tightening Torque*
7495-IP15-1	7495N-IP15-1	8IP-15	8IP-15TL	8IP-15B	61.0 in-lbs (690 N-cm)

*Tightening torques are calculated with a friction coefficient of $\mu = 0.14$ and develop 90% of ultimate yield strength

⚠ WARNING Refer to Speed and Feed charts for recommended adjustments to speeds and feeds. Refer to page A20: 86 for deep hole drilling guidelines in this section of the catalog. Visit www.alliedmachine.com/DeepHoleGuidelines for the most up-to-date information and procedures. Factory technical assistance is available for your specific applications through our Application Engineering Team. ext: 7611 | email: appeng@alliedmachine.com

i = Imperial (in)
m = Metric (mm)

Screws sold in multiples of 10

A

DRILLING

B

BORING

C

REAMING

D

BURNISHING

E

THREADING

X

SPECIALS



GEN3SYS XT Drill Inserts

26 Series | Diameter Range: 1.0236" - 1.1416" (26.00 mm - 28.99 mm)

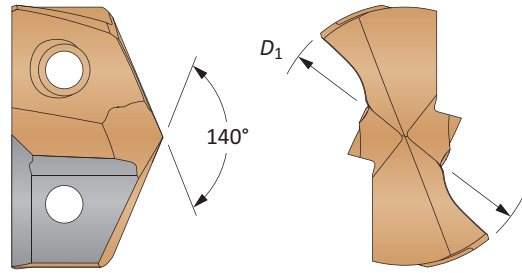
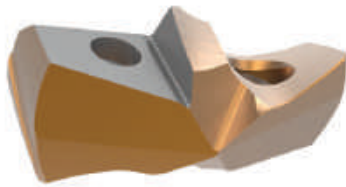

Carbide Substrate	Insert			Standard Part No.	Low Rake Part No.	Cast Iron Part No.	Stainless Part No.
	Fractional Equivalent	D ₁ inch	D ₁ mm				
C1 (K35)		1.0236	26.00	7C126P-26	7C126P-26LR	-	-
	1-1/32	1.0313	26.20	7C126P-0101	7C126P-0101LR	-	-
	1-3/64	1.0469	26.59	7C126P-1.046	7C126P-1.046LR	-	-
	1-1/16	1.0625	26.99	7C126P-0102	7C126P-0102LR	-	-
		1.0630	27.00	7C126P-27	7C126P-27LR	-	-
	1-3/32	1.0938	27.78	7C126P-0103	7C126P-0103LR	-	-
		1.1024	28.00	7C126P-28	7C126P-28LR	-	-
	1-7/64	1.1094	28.17	7C126P-1.109	7C126P-1.109LR	-	-
1-1/8	1.1250	28.58	7C126P-0104	7C126P-0104LR	-	-	
C2 (K20)		1.0236	26.00	7C226P-26	7C226P-26LR	7C226P-26CI	7C226P-26AS
	1-1/32	1.0313	26.20	7C226P-0101	7C226P-0101LR	7C226P-0101CI	7C226P-0101AS
	1-3/64	1.0469	26.59	7C226P-1.046	7C226P-1.046LR	7C226P-1.046CI	7C226P-1.046AS
	1-1/16	1.0625	26.99	7C226P-0102	7C226P-0102LR	7C226P-0102CI	7C226P-0102AS
		1.0630	27.00	7C226P-27	7C226P-27LR	7C226P-27CI	7C226P-27AS
	1-3/32	1.0938	27.78	7C226P-0103	7C226P-0103LR	7C226P-0103CI	7C226P-0103AS
		1.1024	28.00	7C226P-28	7C226P-28LR	7C226P-28CI	7C226P-28AS
	1-7/64	1.1094	28.17	7C226P-1.109	7C226P-1.109LR	7C226P-1.109CI	7C226P-1.109AS
1-1/8	1.1250	28.58	7C226P-0104	7C226P-0104LR	7C226P-0104CI	7C226P-0104AS	

Inserts sold in multiples of 1

A20: 68 - 83

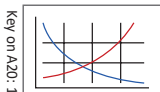

A20: 6 - 9



Sizes not shown are available upon request.
When ordering, please follow the example below:

Imperial:	0.5200", 13 series, C2 = use Part No. 7C213P-.5200
Metric:	13.20 mm, 13 series, C2 = use Part No. 7C213P-13.20

GEN3SYS Drill Insert Holders

26 Series | Diameter Range: 1.0236" - 1.1416" (26.00 mm - 28.99 mm)

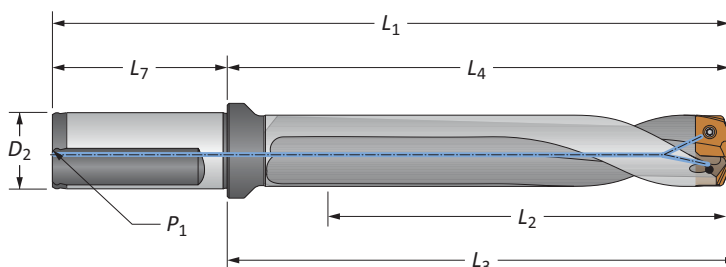

Straight and Helical

Flute	Length	Body				Shank				Flat	Part No.
		L ₂	L ₄	L ₃	L ₁	L ₇	D ₂	P ₁			
	3xD	3-27/64	5-1/16	5-11/64	7-11/32	2-9/32	1-1/4	1/8	YES	60326S-125F	
	5xD	5-45/64	7-11/32	7-29/64	9-5/8	2-9/32	1-1/4	1/8	YES	60526S-125F	
	7xD	7-63/64	9-5/8	9-47/64	11-29/32	2-9/32	1-1/4	1/8	YES	60726S-125F	
	Stub	1-1/4	2-7/8	2-63/64	5-5/32	2-9/32	1-1/4	1/8	YES	60126H-125F	
	3xD	3-27/64	5-1/16	5-11/64	7-11/32	2-9/32	1-1/4	1/8	YES	60326H-125F	
	3xD	3-27/64	5-1/16	5-11/64	7-11/32	2-9/32	1-1/4	1/8	NO	60326H-125C	
	5xD	5-45/64	7-11/32	7-29/64	9-5/8	2-9/32	1-1/4	1/8	YES	60526H-125F	
	5xD	5-45/64	7-11/32	7-29/64	9-5/8	2-9/32	1-1/4	1/8	NO	60526H-125C	
	7xD	7-63/64	9-5/8	9-47/64	11-29/32	2-9/32	1-1/4	1/8	YES	60726H-125F	
	7xD	7-63/64	9-5/8	9-47/64	11-29/32	2-9/32	1-1/4	1/8	NO	60726H-125C	
	7xD	7-63/64	9-5/8	9-47/64	11-29/32	2-9/32	1-1/4	1/8	NO	60726H-125C	
	3xD	87.0	128.6	131.4	188.6	60.0	32.0	1/8*	YES	60326S-32FM	
	5xD	145.0	186.5	189.4	246.5	60.0	32.0	1/8*	YES	60526S-32FM	
	7xD	202.9	244.5	247.4	304.5	60.0	32.0	1/8*	YES	60726S-32FM	
	Stub	32.0	72.9	75.7	132.9	60.0	32.0	1/8*	YES	60126H-32FM	
	3xD	87.0	128.6	131.4	188.6	60.0	32.0	1/8*	YES	60326H-32FM	
	3xD	87.0	128.6	131.4	188.6	60.0	32.0	1/8*	NO	60326H-32CM	
	5xD	145.0	186.5	189.4	246.5	60.0	32.0	1/8*	YES	60526H-32FM	
	5xD	145.0	186.5	189.4	246.5	60.0	32.0	1/8*	NO	60526H-32CM	
	7xD	202.9	244.5	247.4	304.5	60.0	32.0	1/8*	YES	60726H-32FM	
	7xD	202.9	244.5	247.4	304.5	60.0	32.0	1/8*	NO	60726H-32CM	

*Thread to BSP and ISO 7-1

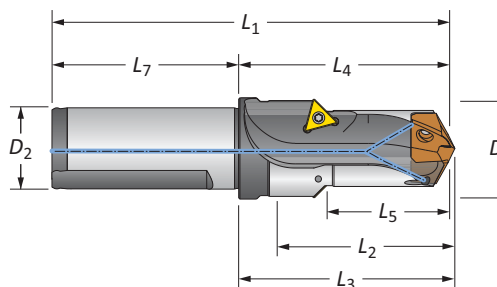

Drill / Chamfer

Step	Body				Shank		Part No.	Chamfer Insert		
	D ₅	L ₅	L ₂	L ₄	L ₃	L ₁			L ₇	D ₂
	1-11/32	1-17/32	2-3/64	2-7/8	2-63/64	5-5/32	2-9/32	1-1/4	60126C45-125F	TCMT-110204
	34.0	39.0	52.1	72.9	75.7	132.9	60.0	32.0	60126C45-32FM	TCMT-110204

Connection Accessories

Insert Screws	Nylon Locking Screws	Insert Driver	Preset Torque Hand Driver	Replacement Tips	Admissible Tightening Torque*
7495-IP15-1	7495N-IP15-1	8IP-15	8IP-15TL	8IP-15B	61.0 in-lbs (690 N-cm)

*Tightening torques are calculated with a friction coefficient of $\mu = 0.14$ and develop 90% of ultimate yield strength



Chamfer inserts sold separately in multiples of 10 | Screws sold in multiples of 10

= Imperial (in)
 = Metric (mm)

GEN3SYS XT Pro Drill Inserts

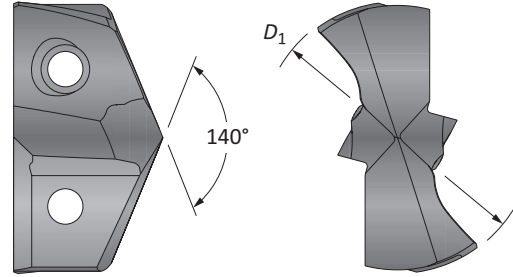
29 Series | Diameter Range: 1.1417" - 1.2597" (29.00 mm - 31.99 mm)



Fractional Equivalent	Insert				
	D ₁ inch	D ₁ mm	P	K	N
-	1.1417	29.00	XTP29-29.00	XTK29-29.00	XTN29-29.00
-	1.1457	29.10	XTP29-29.10	XTK29-29.10	XTN29-29.10
-	1.1496	29.20	XTP29-29.20	XTK29-29.20	XTN29-29.20
-	1.1535	29.30	XTP29-29.30	XTK29-29.30	XTN29-29.30
1-5/32	1.1563	29.37	XTP29-29.37	XTK29-29.37	XTN29-29.37
-	1.1575	29.40	XTP29-29.40	XTK29-29.40	XTN29-29.40
-	1.1614	29.50	XTP29-29.50	XTK29-29.50	XTN29-29.50
-	1.1654	29.60	XTP29-29.60	XTK29-29.60	XTN29-29.60
-	1.1693	29.70	XTP29-29.70	XTK29-29.70	XTN29-29.70
-	1.1732	29.80	XTP29-29.80	XTK29-29.80	XTN29-29.80
-	1.1772	29.90	XTP29-29.90	XTK29-29.90	XTN29-29.90
-	1.1811	30.00	XTP29-30.00	XTK29-30.00	XTN29-30.00
-	1.1850	30.10	XTP29-30.10	XTK29-30.10	XTN29-30.10
1-3/16	1.1874	30.16	XTP29-30.16	XTK29-30.16	XTN29-30.16
-	1.1890	30.20	XTP29-30.20	XTK29-30.20	XTN29-30.20
-	1.1929	30.30	XTP29-30.30	XTK29-30.30	XTN29-30.30
-	1.1969	30.40	XTP29-30.40	XTK29-30.40	XTN29-30.40
-	1.2008	30.50	XTP29-30.50	XTK29-30.50	XTN29-30.50
-	1.2047	30.60	XTP29-30.60	XTK29-30.60	XTN29-30.60
-	1.2087	30.70	XTP29-30.70	XTK29-30.70	XTN29-30.70
-	1.2126	30.80	XTP29-30.80	XTK29-30.80	XTN29-30.80
-	1.2165	30.90	XTP29-30.90	XTK29-30.90	XTN29-30.90
1-7/32	1.2189	30.96	XTP29-30.96	XTK29-30.96	XTN29-30.96
-	1.2205	31.00	XTP29-31.00	XTK29-31.00	XTN29-31.00
-	1.2244	31.10	XTP29-31.10	XTK29-31.10	XTN29-31.10
-	1.2283	31.20	XTP29-31.20	XTK29-31.20	XTN29-31.20
-	1.2323	31.30	XTP29-31.30	XTK29-31.30	XTN29-31.30
-	1.2362	31.40	XTP29-31.40	XTK29-31.40	XTN29-31.40
-	1.2402	31.50	XTP29-31.50	XTK29-31.50	XTN29-31.50
-	1.2441	31.60	XTP29-31.60	XTK29-31.60	XTN29-31.60
-	1.2480	31.70	XTP29-31.70	XTK29-31.70	XTN29-31.70
1-1/4	1.2500	31.75	XTP29-31.75	XTK29-31.75	XTN29-31.75
-	1.2520	31.80	XTP29-31.80	XTK29-31.80	XTN29-31.80
-	1.2559	31.90	XTP29-31.90	XTK29-31.90	XTN29-31.90

Inserts sold in multiples of 1

A20: 68 - 83

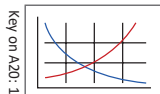

A20: 6 - 9



Sizes not shown are available upon request.	
When ordering, please follow the example below:	
Imperial:	0.5180", Steel, 13 series = use Part No. XTP13-13.16
Metric:	13.16 mm, Steel, 13 series = use Part No. XTP13-13.16

GEN3SYS XT Pro Drill Insert Holders

29 Series | Diameter Range: 1.1417" - 1.2597" (29.00 mm - 31.99 mm)

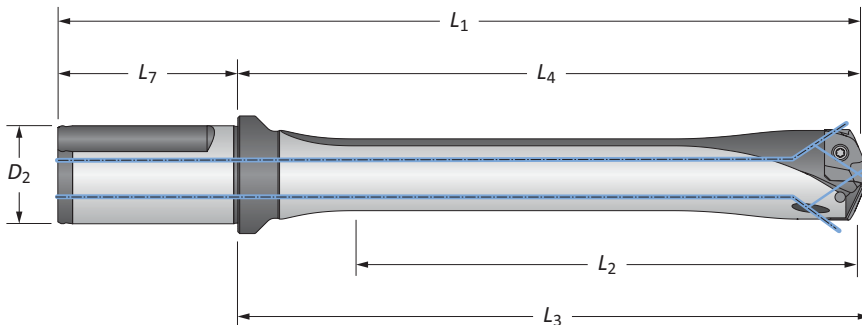

Flute	Body					Shank			Part No.
	Length	L ₂	L ₄	L ₃	L ₁	L ₇	D ₂	Flat	
i Straight	3xD	3-25/32	5-3/8	5-1/2	7-21/32	2-9/32	1-1/4	YES	HXT0329S-125F
	3xD	3-25/32	5-3/8	5-1/2	7-21/32	2-9/32	1-1/4	NO	HXT0329S-125C
	5xD	6-19/64	7-29/32	8-1/64	10-3/16	2-9/32	1-1/4	YES	HXT0529S-125F
	5xD	6-19/64	7-29/32	8-1/64	10-3/16	2-9/32	1-1/4	NO	HXT0529S-125C
	7xD	8-13/16	10-27/64	10-17/64	12-45/64	2-9/32	1-1/4	YES	HXT0729S-125F
	7xD	8-13/16	10-27/64	10-17/64	12-45/64	2-9/32	1-1/4	NO	HXT0729S-125C
	10xD	12-19/32	14-3/16	14-5/16	16-15/32	2-9/32	1-1/4	YES	HXT1029S-125F
10xD	12-19/32	14-3/16	14-5/16	16-15/32	2-9/32	1-1/4	NO	HXT1029S-125C	
ii Straight	3xD	96.0	136.5	139.7	196.5	60.0	32.0	YES	HXT0329S-32FM
	3xD	96.0	136.5	139.7	196.5	60.0	32.0	NO	HXT0329S-32CM
	5xD	160.0	200.8	203.7	260.8	60.0	32.0	YES	HXT0529S-32FM
	5xD	160.0	200.8	203.7	260.8	60.0	32.0	NO	HXT0529S-32CM
	7xD	223.9	264.7	267.6	324.7	60.0	32.0	YES	HXT0729S-32FM
	7xD	223.9	264.7	267.6	324.7	60.0	32.0	NO	HXT0729S-32CM
	10xD	319.9	360.4	363.6	420.4	60.0	32.0	YES	HXT1029S-32FM
	10xD	319.9	360.4	363.6	420.4	60.0	32.0	NO	HXT1029S-32CM

Connection Accessories

					Admissible Tightening Torque*
7495-IP15-1	7495N-IP15-1	8IP-15	8IP-15TL	8IP-15B	61.0 in-lbs (690 N-cm)

*Tightening torques are calculated with a friction coefficient of $\mu = 0.14$ and develop 90% of ultimate yield strength

⚠ WARNING Refer to Speed and Feed charts for recommended adjustments to speeds and feeds. Refer to page A20: 86 for deep hole drilling guidelines in this section of the catalog. Visit www.alliedmachine.com/DeepHoleGuidelines for the most up-to-date information and procedures. Factory technical assistance is available for your specific applications through our Application Engineering Team. ext: 7611 | email: appeng@alliedmachine.com

i = Imperial (in)
m = Metric (mm)

Screws sold in multiples of 10



GEN3SYS XT Drill Inserts

29 Series | Diameter Range: 1.1417" - 1.2597" (29.00 mm - 31.99 mm)

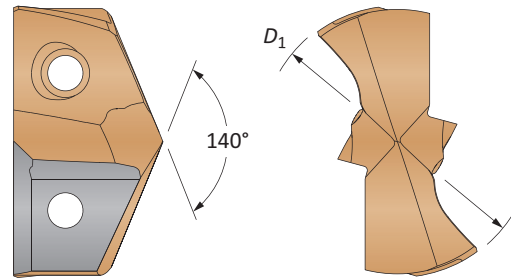

Carbide Substrate	Insert			Standard Part No.	Low Rake Part No.	Cast Iron Part No.	Stainless Part No.
	Fractional Equivalent	D_1 inch	D_1 mm				
C1 (K35)	-	1.1417	29.00	7C129P-29	7C129P-29LR	-	-
	1-5/32	1.1563	29.37	7C129P-0105	7C129P-0105LR	-	-
	-	1.1811	30.00	7C129P-30	7C129P-30LR	-	-
	1-3/16	1.1875	30.16	7C129P-0106	7C129P-0106LR	-	-
	-	1.2008	30.50	7C129P-30.5	7C129P-30.5LR	-	-
	1-7/32	1.2188	30.96	7C129P-0107	7C129P-0107LR	-	-
	-	1.2205	31.00	7C129P-31	7C129P-31LR	-	-
	1-1/4	1.2500	31.75	7C129P-0108	7C129P-0108LR	-	-
C2 (K20)	-	1.1417	29.00	7C229P-29	7C229P-29LR	7C229P-29CI	7C229P-29AS
	1-5/32	1.1563	29.37	7C229P-0105	7C229P-0105LR	7C229P-0105CI	7C229P-0105AS
	-	1.1811	30.00	7C229P-30	7C229P-30LR	7C229P-30CI	7C229P-30AS
	1-3/16	1.1875	30.16	7C229P-0106	7C229P-0106LR	7C229P-0106CI	7C229P-0106AS
	-	1.2008	30.50	7C229P-30.5	7C229P-30.5LR	7C229P-30.5CI	7C229P-30.5AS
	1-7/32	1.2188	30.96	7C229P-0107	7C229P-0107LR	7C229P-0107CI	7C229P-0107AS
	-	1.2205	31.00	7C229P-31	7C229P-31LR	7C229P-31CI	7C229P-31AS
	1-1/4	1.2500	31.75	7C229P-0108	7C229P-0108LR	7C229P-0108CI	7C229P-0108AS

Inserts sold in multiples of 1

A20: 68 - 83

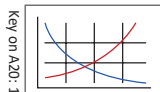

A20: 6 - 9



Key on A20: 1

Sizes not shown are available upon request.

When ordering, please follow the example below:

Imperial:	0.5200", 13 series, C2 = use Part No. 7C213P-5200
Metric:	13.20 mm, 13 series, C2 = use Part No. 7C213P-13.20

GEN3SYS Drill Insert Holders

29 Series | Diameter Range: 1.1417" - 1.2597" (29.00 mm - 31.99 mm)

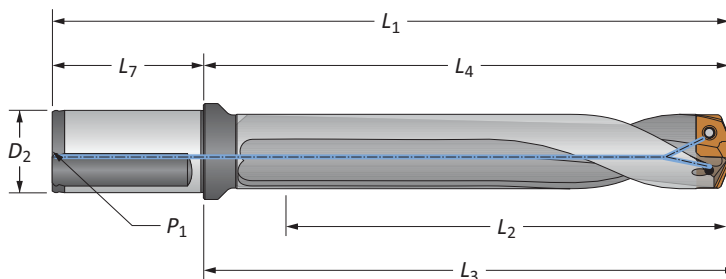

Straight and Helical

Flute	Length	Body				Shank				Flat	Part No.
		L ₂	L ₄	L ₃	L ₁	L ₇	D ₂	P ₁			
	3xD	3-25/32	5-3/8	5-1/2	7-21/32	2-9/32	1-1/4	1/4	YES	60329S-125F	
	5xD	6-19/64	7-29/32	8-1/64	10-3/16	2-9/32	1-1/4	1/4	YES	60529S-125F	
	7xD	8-13/16	10-27/64	10-17/64	12-45/64	2-9/32	1-1/4	1/4	YES	60729S-125F	
	Stub	1-3/8	2-31/32	3-5/64	5-1/4	2-9/32	1-1/4	1/4	YES	60129H-125F	
	3xD	3-25/32	5-3/8	5-1/2	7-21/32	2-9/32	1-1/4	1/4	YES	60329H-125F	
	3xD	3-25/32	5-3/8	5-1/2	7-21/32	2-9/32	1-1/4	1/4	NO	60329H-125C	
	5xD	6-19/64	7-29/32	8-1/64	10-3/16	2-9/32	1-1/4	1/4	YES	60529H-125F	
	5xD	6-19/64	7-29/32	8-1/64	10-3/16	2-9/32	1-1/4	1/4	NO	60529H-125C	
	7xD	8-13/16	10-27/64	10-17/64	12-45/64	2-9/32	1-1/4	1/4	YES	60729H-125F	
	7xD	8-13/16	10-27/64	10-17/64	12-45/64	2-9/32	1-1/4	1/4	NO	60729H-125C	
	Straight	3xD	96.0	136.5	139.7	196.5	60.0	32.0	1/4*	YES	60329S-32FM
		5xD	160.0	200.8	203.7	260.8	60.0	32.0	1/4*	YES	60529S-32FM
		7xD	223.9	264.7	267.6	324.7	60.0	32.0	1/4*	YES	60729S-32FM
	Helical	Stub	35.0	75.2	78.2	135.2	60.0	32.0	1/4*	YES	60129H-32FM
		3xD	96.0	136.5	139.7	196.5	60.0	32.0	1/4*	YES	60329H-32FM
		3xD	96.0	136.5	139.7	196.5	60.0	32.0	1/4*	NO	60329H-32CM
		5xD	160.0	200.8	203.7	260.8	60.0	32.0	1/4*	YES	60529H-32FM
		5xD	160.0	200.8	203.7	260.8	60.0	32.0	1/4*	NO	60529H-32CM
		7xD	223.9	264.7	267.6	324.7	60.0	32.0	1/4*	YES	60729H-32FM
		7xD	223.9	264.7	267.6	324.7	60.0	32.0	1/4*	NO	60729H-32CM

*Thread to BSP and ISO 7-1

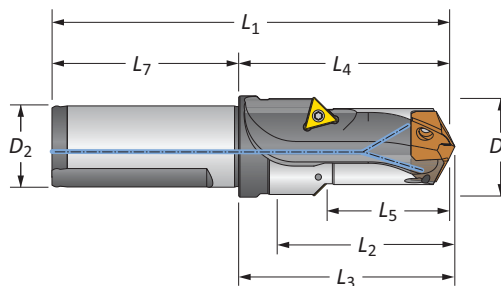

Drill / Chamfer

Step	Body				Shank			Part No.	Chamfer Insert	
	D ₅	L ₅	L ₂	L ₄	L ₃	L ₁	L ₇			D ₂
	1-29/64	1-23/32	2-13/64	2-31/32	3-5/64	5-1/4	2-9/32	1-1/4	60129C45-125F	TCMT-16T304
	37.1	43.5	55.9	75.2	78.2	135.2	60.0	32.0	60129C45-32FM	TCMT-16T304

Connection Accessories

Insert Screws	Nylon Locking Screws	Insert Driver	Preset Torque Hand Driver	Replacement Tips	Admissible Tightening Torque*
7495-IP15-1	7495N-IP15-1	8IP-15	8IP-15TL	8IP-15B	61.0 in-lbs (690 N-cm)

*Tightening torques are calculated with a friction coefficient of $\mu = 0.14$ and develop 90% of ultimate yield strength



Chamfer inserts sold separately in multiples of 10 | Screws sold in multiples of 10

= Imperial (in)
 = Metric (mm)

GEN3SYS XT Pro Drill Inserts

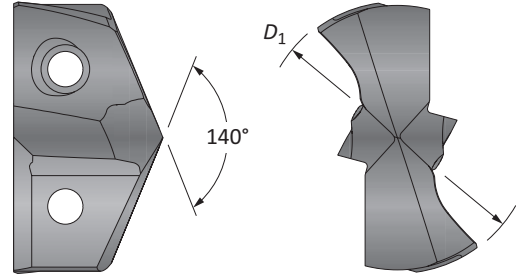
32 Series | Diameter Range: 1.2598" - 1.3780" (32.00 mm - 35.00 mm)



Fractional Equivalent	Insert				
	D ₁ inch	D ₁ mm	Part No. P	Part No. K	Part No. N
-	1.2598	32.00	XTP32-32.00	XTK32-32.00	XTN32-32.00
-	1.2638	32.10	XTP32-32.10	XTK32-32.10	XTN32-32.10
1-17/64	1.2657	32.15	XTP32-32.15	XTK32-32.15	XTN32-32.15
-	1.2677	32.20	XTP32-32.20	XTK32-32.20	XTN32-32.20
-	1.2717	32.30	XTP32-32.30	XTK32-32.30	XTN32-32.30
-	1.2756	32.40	XTP32-32.40	XTK32-32.40	XTN32-32.40
-	1.2795	32.50	XTP32-32.50	XTK32-32.50	XTN32-32.50
1-9/32	1.2815	32.55	XTP32-32.55	XTK32-32.55	XTN32-32.55
-	1.2835	32.60	XTP32-32.60	XTK32-32.60	XTN32-32.60
-	1.2874	32.70	XTP32-32.70	XTK32-32.70	XTN32-32.70
-	1.2913	32.80	XTP32-32.80	XTK32-32.80	XTN32-32.80
-	1.2953	32.90	XTP32-32.90	XTK32-32.90	XTN32-32.90
-	1.2992	33.00	XTP32-33.00	XTK32-33.00	XTN32-33.00
-	1.3031	33.10	XTP32-33.10	XTK32-33.10	XTN32-33.10
-	1.3071	33.20	XTP32-33.20	XTK32-33.20	XTN32-33.20
-	1.3110	33.30	XTP32-33.30	XTK32-33.30	XTN32-33.30
1-5/16	1.3126	33.34	XTP32-33.34	XTK32-33.34	XTN32-33.34
-	1.3150	33.40	XTP32-33.40	XTK32-33.40	XTN32-33.40
-	1.3189	33.50	XTP32-33.50	XTK32-33.50	XTN32-33.50
-	1.3228	33.60	XTP32-33.60	XTK32-33.60	XTN32-33.60
-	1.3268	33.70	XTP32-33.70	XTK32-33.70	XTN32-33.70
-	1.3307	33.80	XTP32-33.80	XTK32-33.80	XTN32-33.80
-	1.3346	33.90	XTP32-33.90	XTK32-33.90	XTN32-33.90
-	1.3386	34.00	XTP32-34.00	XTK32-34.00	XTN32-34.00
-	1.3425	34.10	XTP32-34.10	XTK32-34.10	XTN32-34.10
1-11/32	1.3437	34.13	XTP32-34.13	XTK32-34.13	XTN32-34.13
-	1.3465	34.20	XTP32-34.20	XTK32-34.20	XTN32-34.20
-	1.3504	34.30	XTP32-34.30	XTK32-34.30	XTN32-34.30
-	1.3543	34.40	XTP32-34.40	XTK32-34.40	XTN32-34.40
-	1.3583	34.50	XTP32-34.50	XTK32-34.50	XTN32-34.50
-	1.3622	34.60	XTP32-34.60	XTK32-34.60	XTN32-34.60
-	1.3661	34.70	XTP32-34.70	XTK32-34.70	XTN32-34.70
-	1.3701	34.80	XTP32-34.80	XTK32-34.80	XTN32-34.80
-	1.3740	34.90	XTP32-34.90	XTK32-34.90	XTN32-34.90
1-3/8	1.3752	34.93	XTP32-34.93	XTK32-34.93	XTN32-34.93
-	1.3780	35.00	XTP32-35.00	XTK32-35.00	XTN32-35.00

Inserts sold in multiples of 1

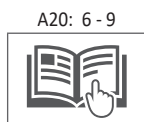
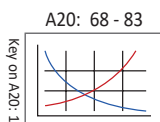

Sizes not shown are available upon request. When ordering, please follow the example below:	
Imperial:	0.5180", Steel, 13 series = use Part No. XTP13-13.16
Metric:	13.16 mm, Steel, 13 series = use Part No. XTP13-13.16

GEN3SYS XT Pro Drill Insert Holders

32 Series | Diameter Range: 1.2598" - 1.3780" (32.00 mm - 35.00 mm)

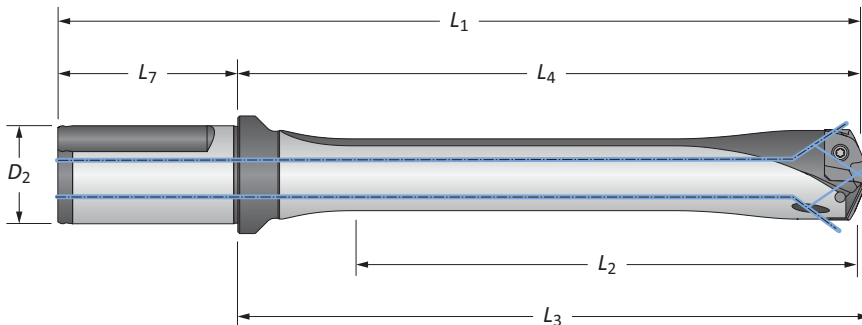

Flute	Body					Shank			Part No.
	Length	L ₂	L ₄	L ₃	L ₁	L ₇	D ₂	Flat	
i Straight	3xD	4-9/64	6-7/32	6-23/64	8-29/32	2-11/16	1-1/2	YES	HXT0332S-150F
	3xD	4-9/64	6-7/32	6-23/64	8-29/32	2-11/16	1-1/2	NO	HXT0332S-150C
	5xD	6-57/64	8-31/32	9-7/64	11-21/32	2-11/16	1-1/2	YES	HXT0532S-150F
	5xD	6-57/64	8-31/32	9-7/64	11-21/32	2-11/16	1-1/2	NO	HXT0532S-150C
	7xD	9-41/64	11-23/32	11-55/64	14-13/32	2-11/16	1-1/2	YES	HXT0732S-150F
	7xD	9-41/64	11-23/32	11-55/64	14-13/32	2-11/16	1-1/2	NO	HXT0732S-150C
	10xD	13-25/32	15-55/64	16	18-35/64	2-11/16	1-1/2	YES	HXT1032S-150F
10xD	13-25/32	15-55/64	16	18-35/64	2-11/16	1-1/2	NO	HXT1032S-150C	
ii Straight	3xD	105.0	157.9	161.5	217.9	60.0	32.0	YES	HXT0332S-32FM
	3xD	105.0	157.9	161.5	217.9	60.0	32.0	NO	HXT0332S-32CM
	5xD	175.0	227.8	231.3	287.8	60.0	32.0	YES	HXT0532S-32FM
	5xD	175.0	227.8	231.3	287.8	60.0	32.0	NO	HXT0532S-32CM
	7xD	245.0	297.6	301.2	357.6	60.0	32.0	YES	HXT0732S-32FM
	7xD	245.0	297.6	301.2	357.6	60.0	32.0	NO	HXT0732S-32CM
	10xD	350.0	402.8	406.4	459.3	60.0	32.0	YES	HXT1032S-32FM
	10xD	350.0	402.8	406.4	459.3	60.0	32.0	NO	HXT1032S-32CM

Connection Accessories

					Admissible Tightening Torque*
7495-IP15-1	7495N-IP15-1	8IP-15	8IP-15TL	8IP-15B	61.0 in-lbs (690 N-cm)

*Tightening torques are calculated with a friction coefficient of $\mu = 0.14$ and develop 90% of ultimate yield strength

⚠ WARNING Refer to Speed and Feed charts for recommended adjustments to speeds and feeds. Refer to page A20: 86 for deep hole drilling guidelines in this section of the catalog. Visit www.alliedmachine.com/DeepHoleGuidelines for the most up-to-date information and procedures. Factory technical assistance is available for your specific applications through our Application Engineering Team. ext: 7611 | email: appeng@alliedmachine.com

i = Imperial (in)
ii = Metric (mm)

Screws sold in multiples of 10

A

DRILLING

B

BORING

C

REAMING

D

BURNISHING

E

THREADING

X

SPECIALS



GEN3SYS XT Drill Inserts

32 Series | Diameter Range: 1.2598" - 1.3780" (32.00 mm - 35.00 mm)

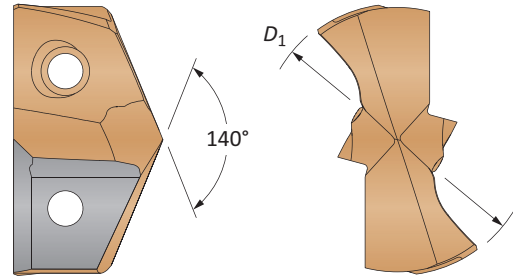
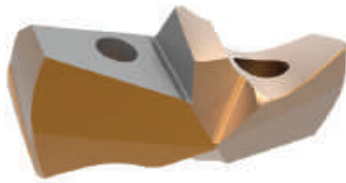

Carbide Substrate	Insert			Standard Part No.	Low Rake Part No.	Cast Iron Part No.	Stainless Part No.
	Fractional Equivalent	D ₁ inch	D ₁ mm				
C1 (K35)	-	1.2598	32.00	7C132P-32	7C132P-32LR	-	-
	1-17/64	1.2658	32.15	7C132P-32.15	7C132P-32.15LR	-	-
	-	1.2795	32.50	7C132P-32.5	7C132P-32.5LR	-	-
	1-9/32	1.2813	32.55	7C132P-0109	7C132P-0109LR	-	-
	-	1.2992	33.00	7C132P-33	7C132P-33LR	-	-
	1-5/16	1.3125	33.34	7C132P-0110	7C132P-0110LR	-	-
	-	1.3189	33.50	7C132P-33.5	7C132P-33.5LR	-	-
	-	1.3386	34.00	7C132P-34	7C132P-34LR	-	-
	1-11/32	1.3438	34.13	7C132P-0111	7C132P-0111LR	-	-
	-	1.3583	34.50	7C132P-34.5	7C132P-34.5LR	-	-
-	1.3750	34.93	7C132P-0112	7C132P-0112LR	-	-	
-	1.3780	35.00	7C132P-35	7C132P-35LR	-	-	
C2 (K20)	-	1.2598	32.00	7C232P-32	7C232P-32LR	7C232P-32CI	7C232P-32AS
	1-17/64	1.2658	32.15	7C232P-32.15	7C232P-32.15LR	7C232P-32.15CI	7C232P-32.15AS
	-	1.2795	32.50	7C232P-32.5	7C232P-32.5LR	7C232P-32.5CI	7C232P-32.5AS
	1-9/32	1.2813	32.55	7C232P-0109	7C232P-0109LR	7C232P-0109CI	7C232P-0109AS
	-	1.2992	33.00	7C232P-33	7C232P-33LR	7C232P-33CI	7C232P-33AS
	1-5/16	1.3125	33.34	7C232P-0110	7C232P-0110LR	7C232P-0110CI	7C232P-0110AS
	-	1.3189	33.50	7C232P-33.5	7C232P-33.5LR	7C232P-33.5CI	7C232P-33.5AS
	-	1.3386	34.00	7C232P-34	7C232P-34LR	7C232P-34CI	7C232P-34AS
	1-11/32	1.3438	34.13	7C232P-0111	7C232P-0111LR	7C232P-0111CI	7C232P-0111AS
	-	1.3583	34.50	7C232P-34.5	7C232P-34.5LR	7C232P-34.5CI	7C232P-34.5AS
-	1.3750	34.93	7C232P-0112	7C232P-0112LR	7C232P-0112CI	7C232P-0112AS	
-	1.3780	35.00	7C232P-35	7C232P-35LR	7C232P-35CI	7C232P-35AS	

Inserts sold in multiples of 1

A20: 68 - 83

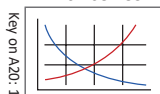

A20: 6 - 9



Sizes not shown are available upon request.
When ordering, please follow the example below:

Imperial:	0.5200", 13 series, C2 = use Part No. 7C213P-.5200
Metric:	13.20 mm, 13 series, C2 = use Part No. 7C213P-13.20

GEN3SYS Drill Insert Holders

32 Series | Diameter Range: 1.2598" - 1.3780" (32.00 mm - 35.00 mm)

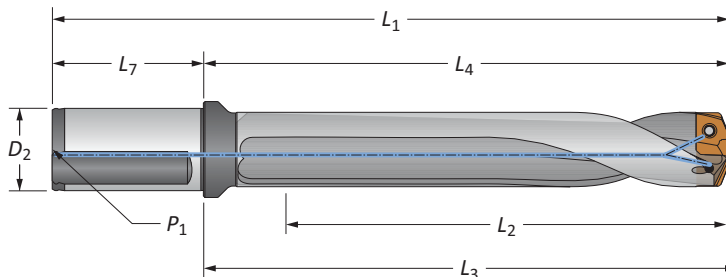

Straight and Helical

Flute	Length	Body				Shank				Flat	Part No.
		L ₂	L ₄	L ₃	L ₁	L ₇	D ₂	P ₁			
	3xD	4-9/64	6-7/32	6-23/64	8-29/32	2-11/16	1-1/2	1/4	YES	60332S-150F	
	5xD	6-57/64	8-31/32	9-7/64	11-21/32	2-11/16	1-1/2	1/4	YES	60532S-150F	
	7xD	9-41/64	11-23/32	11-55/64	14-13/32	2-11/16	1-1/2	1/4	YES	60732S-150F	
	Stub	1-1/2	3-37/64	3-45/64	6-1/4	2-11/16	1-1/2	1/4	YES	60132H-150F	
	3xD	4-9/64	6-7/32	6-23/64	8-29/32	2-11/16	1-1/2	1/4	YES	60332H-150F	
	3xD	4-9/64	6-7/32	6-23/64	8-29/32	2-11/16	1-1/2	1/4	NO	60332H-150C	
	5xD	6-57/64	8-31/32	9-7/64	11-21/32	2-11/16	1-1/2	1/4	YES	60532H-150F	
	5xD	6-57/64	8-31/32	9-7/64	11-21/32	2-11/16	1-1/2	1/4	NO	60532H-150C	
	7xD	9-41/64	11-23/32	11-55/64	14-13/32	2-11/16	1-1/2	1/4	YES	60732H-150F	
	7xD	9-41/64	11-23/32	11-55/64	14-13/32	2-11/16	1-1/2	1/4	NO	60732H-150C	
	3xD	105.0	150.7	154.3	220.7	70.0	40.0	1/4*	YES	60332S-40FM	
	5xD	175.0	220.7	224.3	290.7	70.0	40.0	1/4*	YES	60532S-40FM	
	7xD	245.0	290.7	294.3	360.7	70.0	40.0	1/4*	YES	60732S-40FM	
	Stub	38.0	90.7	94.2	160.7	70.0	40.0	1/4*	YES	60132H-40FM	
	3xD	105.0	150.7	154.3	220.7	70.0	40.0	1/4*	YES	60332H-40FM	
	3xD	105.0	150.7	154.3	220.7	70.0	40.0	1/4*	NO	60332H-40CM	
	5xD	175.0	220.7	224.3	290.7	70.0	40.0	1/4*	YES	60532H-40FM	
	5xD	175.0	220.7	224.3	290.7	70.0	40.0	1/4*	NO	60532H-40CM	
	7xD	245.0	290.7	294.3	360.7	70.0	40.0	1/4*	YES	60732H-40FM	
	7xD	245.0	290.7	294.3	360.7	70.0	40.0	1/4*	NO	60732H-40CM	

*Thread to BSP and ISO 7-1

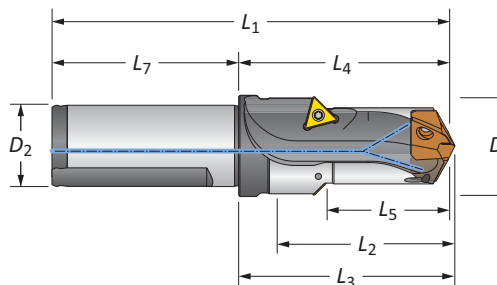

Drill / Chamfer

Step	Body				Shank			Part No.	Chamfer Insert
	D ₅	L ₅	L ₂	L ₄	L ₃	L ₁	L ₇		
1-37/64	1-57/64	2-29/64	3-37/64	3-23/32	6-1/4	2-11/16	1-1/2	60132C45-150F	TCMT-16T304
40.1	48.0	62.4	90.7	94.2	160.7	70.0	40.0	60132C45-40FM	TCMT-16T304

Connection Accessories

					Admissible Tightening Torque*
7495-IP15-1	7495N-IP15-1	8IP-15	8IP-15TL	8IP-15B	61.0 in-lbs (690 N-cm)

*Tightening torques are calculated with a friction coefficient of $\mu = 0.14$ and develop 90% of ultimate yield strength

Chamfer inserts sold separately in multiples of 10 | Screws sold in multiples of 10

= Imperial (in)
 = Metric (mm)

Recommended Drilling Data | Imperial (inch)

GEN3SYS XT Pro

ISO	Material	Hardness (BHN)	Speed (SFM)	Feed Rate (IPR) by Diameter			
				11 series 0.4331" - 0.4723"	12 series 0.4724" - 0.5117"	13 series 0.5118" - 0.5511"	14 series 0.5512" - 0.5905"
P	Free-Machining Steel 1118, 1215, 12L14, etc.	100 - 150	550	0.011	0.012	0.013	0.014
		150 - 200	475	0.010	0.011	0.012	0.013
		200 - 250	425	0.008	0.009	0.010	0.011
	Low-Carbon Steel 1010, 1020, 1025, 1522, 1144, etc.	85 - 125	520	0.011	0.012	0.013	0.014
		125 - 175	450	0.010	0.011	0.012	0.013
		175 - 225	410	0.009	0.010	0.011	0.012
	Medium-Carbon Steel 1030, 1040, 1050, 1527, 1140, 1151, etc.	225 - 275	350	0.007	0.008	0.009	0.010
		125 - 175	450	0.010	0.011	0.012	0.013
		175 - 225	410	0.009	0.010	0.011	0.012
	Alloy Steel 4140, 5140, 8640, etc.	225 - 275	350	0.008	0.009	0.010	0.011
		275 - 325	300	0.007	0.008	0.009	0.010
		125 - 175	415	0.010	0.011	0.012	0.013
		175 - 225	380	0.009	0.010	0.011	0.012
	High-Strength Alloy 4340, 4330V, 300M, etc.	225 - 275	340	0.008	0.009	0.010	0.011
		275 - 325	310	0.006	0.007	0.008	0.009
		325 - 375	280	0.006	0.006	0.007	0.008
	Structural Steel A36, A285, A516, etc.	225 - 300	250	0.008	0.009	0.010	0.011
		300 - 350	225	0.006	0.007	0.008	0.009
		350 - 400	200	0.005	0.006	0.007	0.008
	Tool Steel H-13, H-21, A-4, O-2, S-3, etc.	100 - 150	410	0.010	0.011	0.012	0.013
150 - 250		330	0.008	0.009	0.010	0.011	
250 - 350		305	0.007	0.008	0.009	0.010	
S	High-Temp Alloy Hastelloy B, Inconel 600, etc.	150 - 200	265	0.006	0.007	0.007	0.008
		200 - 250	205	0.005	0.006	0.006	0.007
	Titanium Alloy	140 - 220	130	0.006	0.007	0.007	0.008
		220 - 310	100	0.005	0.006	0.006	0.007
	Aerospace Alloy S82	140 - 220	140	0.005	0.006	0.007	0.008
220 - 310		110	0.004	0.005	0.006	0.007	
M	Stainless Steel 400 Series 416, 420, etc.	185 - 275	165	0.004	0.004	0.005	0.005
		275 - 350	180	0.005	0.006	0.006	0.007
	Stainless Steel 300 Series 304, 316, 17-4PH, etc.	185 - 275	160	0.003	0.004	0.004	0.005
		135 - 185	220	0.004	0.005	0.005	0.006
	Super Duplex Stainless Steel	135 - 185	125	0.003	0.003	0.003	0.004
		185 - 275	100	0.002	0.002	0.003	0.003

7xD Adjustment Example (0.80 Adjustment)

Data • Adjustment Value	Speed/Feed (7xD)
200 SFM • 0.80	= 160 SFM
0.008 IPR • 0.80	= 0.0064 IPR

10xD and 12xD Adjustment Example (0.70 Adjustment)

Speed • Adjustment Value	Speed/Feed (10xD/12xD)
200 SFM • 0.70	= 140 SFM
0.008 IPR • 0.70	= 0.0056 IPR

⚠ WARNING Tool failure can cause serious injury. To prevent:

- When using holders without support bushing, use a short GEN3SYS holder to establish an initial hole that is a minimum of 2 diameters deep.
- Do not rotate tool holders more than 50 RPM unless it is engaged with the workpiece or fixture.

Visit www.alliedmachine.com/DeepHoleGuidelines for the most up-to-date information and procedures. Factory technical assistance is available for your specific applications through our Application Engineering Team. ext: 7611 | email: appeng@alliedmachine.com

IMPORTANT: The speeds and feeds listed above are a general starting point for all applications. Refer to the coolant recommendation charts for coolant requirements to run at the recommended speeds and feeds. Factory technical assistance is available through our Application Engineering department. For 7xD, 10xD, and 12xD holder lengths, see adjustment examples above.

A
DRILLING
B
BORING
C
REAMING
D
BURNISHING
E
THREADING
X
SPECIALS

Feed Rate (IPR) by Diameter									
15 series 0.5906" - 0.6298"	16 series 0.6299" - 0.6692"	17 series 0.6693" - 0.7086"	18 series 0.7087" - 0.7873"	20 series 0.7874" - 0.8660"	22 series 0.8661" - 0.9448"	24 series 0.9449" - 1.0235"	26 series 1.0236" - 1.1416"	29 series 1.1417" - 1.2597"	32 series 1.2598" - 1.3780"
0.015	0.016	0.017	0.019	0.021	0.022	0.023	0.024	0.025	0.026
0.014	0.015	0.016	0.017	0.019	0.020	0.021	0.022	0.023	0.024
0.012	0.013	0.014	0.016	0.018	0.019	0.020	0.021	0.022	0.023
0.015	0.016	0.017	0.019	0.021	0.022	0.023	0.024	0.025	0.026
0.014	0.015	0.016	0.018	0.019	0.020	0.021	0.022	0.023	0.024
0.013	0.014	0.015	0.017	0.018	0.019	0.020	0.021	0.022	0.023
0.011	0.012	0.013	0.015	0.016	0.017	0.018	0.019	0.020	0.021
0.014	0.015	0.016	0.018	0.020	0.021	0.022	0.023	0.024	0.025
0.013	0.014	0.015	0.017	0.019	0.020	0.021	0.022	0.023	0.024
0.012	0.013	0.014	0.016	0.018	0.019	0.020	0.021	0.022	0.023
0.011	0.012	0.013	0.015	0.016	0.017	0.018	0.019	0.020	0.021
0.014	0.015	0.016	0.018	0.020	0.021	0.022	0.023	0.024	0.025
0.013	0.014	0.015	0.017	0.019	0.020	0.021	0.022	0.023	0.024
0.012	0.013	0.014	0.016	0.018	0.019	0.020	0.021	0.022	0.023
0.010	0.011	0.012	0.014	0.015	0.016	0.017	0.018	0.019	0.020
0.009	0.010	0.011	0.013	0.014	0.015	0.016	0.017	0.018	0.019
0.011	0.012	0.013	0.014	0.015	0.016	0.017	0.018	0.019	0.020
0.010	0.011	0.011	0.012	0.013	0.014	0.015	0.016	0.017	0.018
0.009	0.010	0.010	0.011	0.012	0.013	0.014	0.015	0.016	0.017
0.013	0.015	0.015	0.017	0.019	0.021	0.022	0.023	0.024	0.025
0.012	0.013	0.014	0.015	0.017	0.019	0.020	0.021	0.022	0.023
0.011	0.012	0.013	0.014	0.015	0.017	0.019	0.020	0.021	0.022
0.008	0.009	0.009	0.010	0.011	0.012	0.013	0.014	0.015	0.016
0.007	0.008	0.008	0.009	0.010	0.011	0.012	0.013	0.014	0.015
0.008	0.009	0.009	0.010	0.011	0.011	0.012	0.012	0.013	0.014
0.007	0.008	0.008	0.009	0.010	0.010	0.011	0.011	0.012	0.013
0.008	0.009	0.009	0.010	0.011	0.011	0.012	0.012	0.013	0.014
0.007	0.008	0.008	0.009	0.010	0.010	0.011	0.011	0.012	0.012
0.006	0.006	0.007	0.007	0.008	0.008	0.009	0.010	0.011	0.012
0.005	0.006	0.006	0.006	0.007	0.008	0.008	0.009	0.010	0.011
0.008	0.009	0.010	0.011	0.012	0.013	0.014	0.015	0.016	0.017
0.007	0.008	0.009	0.010	0.011	0.012	0.013	0.014	0.015	0.016
0.006	0.007	0.007	0.008	0.008	0.009	0.009	0.010	0.010	0.011
0.005	0.006	0.006	0.007	0.007	0.008	0.008	0.009	0.009	0.010
0.004	0.005	0.005	0.006	0.006	0.007	0.008	0.008	0.008	0.010
0.004	0.004	0.005	0.005	0.006	0.006	0.007	0.007	0.008	0.008

Coolant Recommendations

Series	Stub, 3xD, 5xD		7xD		10xD, 12xD	
	Pressure PSI	Flow Rate GPM	Pressure PSI	Flow Rate GPM	Pressure PSI	Flow Rate GPM
11	450	5	600	8	800	10
12	450	5	600	8	800	10
13	400	6	500	9.5	750	12
14	400	7	500	9.5	750	12
15	380	7	475	11	700	14
16	380	8	475	12	700	15
17	350	8	450	12.5	650	16.5
18	350	9	450	12.5	650	16.5
20	300	10	400	13	600	18
22	300	11	400	14	600	18
24	300	11	400	14	600	18
26	300	12	400	16	600	20
29	300	12	400	16	600	20
32	300	12	400	16	600	20

Recommended Drilling Data | Imperial (inch)

GEN3SYS XT Pro

ISO	Material	Hardness (BHN)	Speed (SFM)	Feed Rate (IPR) by Diameter			
				11 series 0.4331" - 0.4723"	12 series 0.4724" - 0.5117"	13 series 0.5118" - 0.5511"	14 series 0.5512" - 0.5905"
H	Wear Plate Hardox®, AR400, T-1, etc.	400	160	0.005	0.005	0.006	0.006
		500	130	0.004	0.004	0.005	0.006
		600	90	0.004	0.004	0.004	0.005
	Hardened Steel	300 - 400	170	0.005	0.005	0.006	0.006
400 - 500		130	0.004	0.004	0.005	0.006	
K	SG / Nodular Cast Iron	120 - 150	550	0.010	0.012	0.013	0.014
		150 - 200	520	0.010	0.011	0.012	0.013
		200 - 220	465	0.008	0.010	0.011	0.012
		220 - 260	405	0.008	0.009	0.010	0.011
		260 - 320	365	0.008	0.008	0.009	0.010
	Grey / White Iron	120 - 150	575	0.012	0.013	0.014	0.015
		150 - 200	550	0.011	0.012	0.013	0.014
		200 - 220	495	0.010	0.011	0.012	0.013
		220 - 260	425	0.009	0.010	0.011	0.012
		260 - 320	380	0.009	0.010	0.011	0.012
N	Cast Aluminum	30	1150	0.012	0.013	0.014	0.015
		180	860	0.011	0.012	0.013	0.014
	Wrought Aluminum	30	1600	0.013	0.015	0.016	0.017
		180	1150	0.012	0.014	0.015	0.016
	Aluminum Bronze	100 - 200	415	0.010	0.011	0.012	0.012
		200 - 250	335	0.008	0.009	0.010	0.011
	Brass	100	755	0.010	0.012	0.013	0.014
Copper	60	490	0.003	0.003	0.003	0.004	

7xD Adjustment Example (0.80 Adjustment)

Data • Adjustment Value	Speed/Feed (7xD)
200 SFM • 0.80	= 160 SFM
0.008 IPR • 0.80	= 0.0064 IPR

10xD and 12xD Adjustment Example (0.70 Adjustment)

Speed • Adjustment Value	Speed/Feed (10xD/12xD)
200 SFM • 0.70	= 140 SFM
0.008 IPR • 0.70	= 0.0056 IPR

⚠ WARNING Tool failure can cause serious injury. To prevent:

- When using holders without support bushing, use a short GEN3SYS holder to establish an initial hole that is a minimum of 2 diameters deep.
- Do not rotate tool holders more than 50 RPM unless it is engaged with the workpiece or fixture.

Visit www.alliedmachine.com/DeepHoleGuidelines for the most up-to-date information and procedures. Factory technical assistance is available for your specific applications through our Application Engineering Team. ext: 7611 | email: appeng@alliedmachine.com

IMPORTANT: The speeds and feeds listed above are a general starting point for all applications. Refer to the coolant recommendation charts for coolant requirements to run at the recommended speeds and feeds. Factory technical assistance is available through our Application Engineering department. For 7xD, 10xD, and 12xD holder lengths, see adjustment example above.

A
DRILLING
B
BORING
C
REAMING
D
BURNISHING
E
THREADING
X
SPECIALS

Feed Rate (IPR) by Diameter									
15 series 0.5906" - 0.6298"	16 series 0.6299" - 0.6692"	17 series 0.6693" - 0.7086"	18 series 0.7087" - 0.7873"	20 series 0.7874" - 0.8660"	22 series 0.8661" - 0.9448"	24 series 0.9449" - 1.0235"	26 series 1.0236" - 1.1416"	29 series 1.1417" - 1.2597"	32 series 1.2598" - 1.3780"
0.007	0.008	0.009	0.010	0.010	0.010	0.011	0.011	0.012	0.012
0.006	0.007	0.008	0.009	0.010	0.010	0.010	0.010	0.011	0.011
0.006	0.006	0.007	0.008	0.009	0.009	0.010	0.010	0.010	0.010
0.007	0.008	0.008	0.009	0.010	0.010	0.010	0.010	0.011	0.011
0.006	0.007	0.008	0.008	0.009	0.009	0.010	0.010	0.010	0.010
0.015	0.016	0.018	0.020	0.020	0.022	0.022	0.024	0.025	0.026
0.014	0.015	0.017	0.019	0.020	0.020	0.022	0.022	0.024	0.024
0.013	0.014	0.016	0.018	0.019	0.020	0.020	0.022	0.022	0.023
0.012	0.013	0.015	0.017	0.018	0.019	0.020	0.020	0.022	0.022
0.011	0.012	0.014	0.015	0.017	0.018	0.019	0.020	0.020	0.021
0.016	0.017	0.019	0.021	0.022	0.023	0.024	0.025	0.026	0.027
0.015	0.016	0.018	0.020	0.021	0.022	0.023	0.024	0.025	0.026
0.014	0.015	0.017	0.020	0.020	0.021	0.022	0.023	0.024	0.025
0.013	0.014	0.016	0.018	0.019	0.020	0.021	0.022	0.023	0.024
0.013	0.014	0.015	0.017	0.018	0.019	0.020	0.021	0.022	0.023
0.016	0.017	0.018	0.019	0.020	0.021	0.022	0.023	0.024	0.025
0.015	0.016	0.017	0.018	0.019	0.020	0.021	0.022	0.023	0.023
0.018	0.019	0.020	0.022	0.023	0.024	0.026	0.027	0.029	0.030
0.017	0.018	0.019	0.021	0.022	0.023	0.025	0.026	0.028	0.029
0.013	0.014	0.015	0.015	0.016	0.017	0.018	0.019	0.019	0.019
0.012	0.012	0.013	0.014	0.015	0.016	0.017	0.018	0.018	0.019
0.015	0.016	0.017	0.019	0.020	0.022	0.023	0.024	0.026	0.026
0.005	0.006	0.006	0.007	0.008	0.008	0.008	0.010	0.010	0.011

Coolant Recommendations

Series	Stub, 3xD, 5xD		7xD		10xD, 12xD	
	Pressure PSI	Flow Rate GPM	Pressure PSI	Flow Rate GPM	Pressure PSI	Flow Rate GPM
11	450	5	600	8	800	10
12	450	5	600	8	800	10
13	400	6	500	9.5	750	12
14	400	7	500	9.5	750	12
15	380	7	475	11	700	14
16	380	8	475	12	700	15
17	350	8	450	12.5	650	16.5
18	350	9	450	12.5	650	16.5
20	300	10	400	13	600	18
22	300	11	400	14	600	18
24	300	11	400	14	600	18
26	300	12	400	16	600	20
29	300	12	400	16	600	20
32	300	12	400	16	600	20

Recommended Drilling Data | Imperial (inch)

GEN3SYS XT

ISO	Material	Hardness (BHN)	Speed (SFM)	Feed Rate (IPR) by Diameter			
				11 series 0.4331" - 0.4723"	12 series 0.4724" - 0.5117"	13 series 0.5118" - 0.5511"	14 series 0.5512" - 0.5905"
P	Free-Machining Steel 1118, 1215, 12L14, etc.	100 - 150	480	0.009	0.011	0.012	0.013
		150 - 200	415	0.009	0.010	0.011	0.012
		200 - 250	390	0.007	0.008	0.009	0.010
	Low-Carbon Steel 1010, 1020, 1025, 1522, 1144, etc.	85 - 125	450	0.010	0.011	0.012	0.013
		125 - 175	390	0.009	0.010	0.011	0.012
		175 - 225	355	0.008	0.009	0.010	0.011
	Medium-Carbon Steel 1030, 1040, 1050, 1527, 1140, 1151, etc.	225 - 275	310	0.006	0.007	0.008	0.009
		125 - 175	390	0.009	0.010	0.011	0.012
		175 - 225	355	0.008	0.009	0.010	0.011
	Alloy Steel 4140, 5140, 8640, etc.	225 - 275	310	0.007	0.008	0.009	0.010
		275 - 325	265	0.006	0.007	0.008	0.009
		125 - 175	375	0.009	0.010	0.011	0.012
		175 - 225	345	0.008	0.009	0.010	0.011
	High-Strength Alloy 4340, 4330V, 300M, etc.	225 - 275	310	0.007	0.008	0.009	0.010
		275 - 325	285	0.006	0.006	0.007	0.008
		325 - 375	255	0.006	0.006	0.006	0.007
	Structural Steel A36, A285, A516, etc.	100 - 150	355	0.009	0.010	0.011	0.012
		150 - 250	285	0.007	0.008	0.009	0.010
250 - 350		265	0.006	0.007	0.008	0.009	
Tool Steel H-13, H-21, A-4, O-2, S-3, etc.	150 - 200	255	0.006	0.006	0.006	0.007	
	200 - 250	195	0.005	0.006	0.006	0.006	
S	High-Temp Alloy Hastelloy B, Inconel 600, etc.	140 - 220	120	0.006	0.006	0.006	0.007
		220 - 310	95	0.005	0.006	0.006	0.006
	Titanium Alloy	140 - 220	140	0.005	0.006	0.006	0.007
		220 - 310	110	0.004	0.005	0.006	0.006
	Aerospace Alloy S82	185 - 275	145	0.004	0.004	0.005	0.005
275 - 350		120	0.003	0.003	0.004	0.005	
M	Stainless Steel 400 Series 416, 420, etc.	185 - 275	240	0.006	0.007	0.007	0.008
		275 - 350	185	0.005	0.006	0.006	0.007
	Stainless Steel 300 Series 304, 316, 17-4PH, etc.	135 - 185	220	0.004	0.005	0.005	0.006
		185 - 275	160	0.003	0.004	0.004	0.005
	Super Duplex Stainless Steel	135 - 185	125	0.003	0.003	0.003	0.004
185 - 275		100	0.002	0.002	0.003	0.003	

7xD Adjustment Example (0.80 Adjustment)

Data • Adjustment Value	Speed/Feed (7xD)
200 SFM • 0.80	= 160 SFM
0.008 IPR • 0.80	= 0.0064 IPR

⚠ WARNING Tool failure can cause serious injury. To prevent:

- When using holders without support bushing, use a short GEN3SYS holder to establish an initial hole that is a minimum of 2 diameters deep.
- Do not rotate tool holders more than 50 RPM unless it is engaged with the workpiece or fixture.

Visit www.alliedmachine.com/DeepHoleGuidelines for the most up-to-date information and procedures. Factory technical assistance is available for your specific applications through our Application Engineering Team. ext: 7611 | email: appeng@alliedmachine.com

IMPORTANT: The speeds and feeds listed above are a general starting point for all applications. Refer to the coolant recommendation charts for coolant requirements to run at the recommended speeds and feeds. Factory technical assistance is available through our Application Engineering department. For 7xD, 10xD, and 12xD holder lengths, see adjustment example above.

A
DRILLING
B
BORING
C
REAMING
D
BURNISHING
E
THREADING
X
SPECIALS

Feed Rate (IPR) by Diameter									
15 series 0.5906" - 0.6298"	16 series 0.6299" - 0.6692"	17 series 0.6693" - 0.7086"	18 series 0.7087" - 0.7873"	20 series 0.7874" - 0.8660"	22 series 0.8661" - 0.9448"	24 series 0.9449" - 1.0235"	26 series 1.0236" - 1.1416"	29 series 1.1417" - 1.2597"	32 series 1.2598" - 1.3780"
0.014	0.015	0.016	0.017	0.019	0.020	0.021	0.022	0.023	0.024
0.013	0.014	0.015	0.016	0.017	0.018	0.019	0.020	0.021	0.022
0.011	0.012	0.013	0.015	0.017	0.017	0.018	0.019	0.020	0.021
0.014	0.015	0.016	0.017	0.019	0.020	0.021	0.022	0.023	0.024
0.013	0.014	0.015	0.016	0.017	0.018	0.019	0.020	0.021	0.022
0.012	0.013	0.014	0.015	0.016	0.017	0.018	0.019	0.020	0.021
0.010	0.011	0.012	0.014	0.015	0.016	0.017	0.017	0.018	0.019
0.013	0.014	0.015	0.017	0.018	0.019	0.020	0.021	0.022	0.023
0.012	0.013	0.014	0.016	0.017	0.018	0.019	0.020	0.021	0.022
0.011	0.012	0.013	0.015	0.016	0.017	0.018	0.019	0.020	0.021
0.010	0.011	0.012	0.014	0.015	0.016	0.017	0.017	0.018	0.019
0.013	0.014	0.015	0.017	0.018	0.019	0.020	0.021	0.022	0.023
0.012	0.013	0.014	0.016	0.017	0.018	0.019	0.020	0.021	0.022
0.011	0.012	0.013	0.015	0.015	0.017	0.018	0.019	0.020	0.021
0.009	0.010	0.011	0.013	0.014	0.015	0.016	0.017	0.018	0.018
0.008	0.009	0.010	0.012	0.013	0.014	0.015	0.016	0.017	0.017
0.010	0.011	0.012	0.013	0.014	0.015	0.016	0.017	0.017	0.018
0.009	0.010	0.010	0.011	0.012	0.013	0.014	0.015	0.016	0.017
0.008	0.009	0.009	0.010	0.011	0.012	0.013	0.014	0.015	0.016
0.012	0.014	0.014	0.016	0.017	0.019	0.020	0.021	0.022	0.023
0.011	0.012	0.013	0.014	0.016	0.017	0.018	0.019	0.020	0.021
0.010	0.011	0.012	0.013	0.014	0.016	0.017	0.018	0.019	0.020
0.007	0.008	0.008	0.009	0.010	0.011	0.012	0.013	0.014	0.015
0.006	0.007	0.007	0.008	0.009	0.010	0.011	0.012	0.013	0.014
0.007	0.008	0.008	0.009	0.010	0.010	0.011	0.011	0.012	0.013
0.006	0.007	0.007	0.008	0.009	0.009	0.010	0.010	0.011	0.012
0.007	0.008	0.008	0.009	0.010	0.010	0.011	0.011	0.012	0.013
0.006	0.007	0.007	0.008	0.009	0.009	0.010	0.010	0.011	0.011
0.006	0.006	0.006	0.006	0.007	0.007	0.008	0.009	0.010	0.011
0.005	0.006	0.006	0.006	0.006	0.007	0.007	0.008	0.009	0.010
0.008	0.009	0.010	0.011	0.012	0.013	0.014	0.015	0.016	0.017
0.007	0.008	0.009	0.010	0.011	0.012	0.013	0.014	0.015	0.016
0.006	0.007	0.007	0.008	0.008	0.009	0.009	0.010	0.010	0.011
0.005	0.006	0.006	0.007	0.007	0.008	0.008	0.009	0.009	0.010
0.004	0.005	0.005	0.006	0.006	0.007	0.008	0.008	0.008	0.010
0.004	0.004	0.005	0.005	0.006	0.006	0.007	0.007	0.008	0.008

Coolant Recommendations

Series	3xD, 5xD		7xD		10xD, 12xD	
	Pressure PSI	Flow Rate GPM	Pressure PSI	Flow Rate GPM	Pressure PSI	Flow Rate GPM
11	450	5	600	8	800	10
12	450	5	600	8	800	10
13	400	6	500	9.5	750	12
14	400	7	500	9.5	750	12
15	380	7	475	11	700	14
16	380	8	475	12	700	15
17	350	8	450	12.5	650	16.5
18	350	9	450	12.5	650	16.5
20	300	10	400	13	600	18
22	300	11	400	14	600	18
24	300	11	400	14	600	18
26	300	12	400	16	600	20
29	300	12	400	16	600	20
32	300	12	400	16	600	20

Recommended Drilling Data | Imperial (inch)

GEN3SYS XT

ISO	Material	Hardness (BHN)	Speed (SFM)	Feed Rate (IPR) by Diameter			
				11 series 0.4331" - 0.4723"	12 series 0.4724" - 0.5117"	13 series 0.5118" - 0.5511"	14 series 0.5512" - 0.5905"
H	Wear Plate Hardox®, AR400, T-1, etc.	400	145	0.005	0.005	0.006	0.006
		500	110	0.004	0.004	0.005	0.006
		600	80	0.004	0.004	0.004	0.005
	Hardened Steel	300 - 400	155	0.005	0.005	0.006	0.006
400 - 500		120	0.004	0.004	0.005	0.006	
K	SG / Nodular Cast Iron	120 - 150	480	0.009	0.011	0.012	0.013
		150 - 200	450	0.009	0.010	0.011	0.012
		200 - 220	400	0.007	0.009	0.010	0.011
		220 - 260	350	0.007	0.008	0.009	0.010
		260 - 320	320	0.007	0.007	0.008	0.009
	Grey / White Iron	120 - 150	500	0.011	0.012	0.013	0.014
		150 - 200	480	0.010	0.011	0.012	0.013
		200 - 220	430	0.009	0.010	0.011	0.012
		220 - 260	370	0.008	0.009	0.010	0.011
		260 - 320	335	0.008	0.009	0.010	0.011
N	Cast Aluminum	30	1000	0.011	0.012	0.013	0.014
		180	750	0.010	0.011	0.012	0.013
	Wrought Aluminum	30	1400	0.012	0.014	0.015	0.016
		180	1000	0.011	0.013	0.014	0.015
	Aluminum Bronze	100 - 200	360	0.009	0.010	0.011	0.011
		200 - 250	295	0.007	0.008	0.009	0.010
	Brass	100	660	0.009	0.011	0.012	0.013
Copper	60	425	0.003	0.003	0.003	0.004	

7xD Adjustment Example (0.80 Adjustment)

Data • Adjustment Value	Speed/Feed (7xD)
200 SFM • 0.80	= 160 SFM
0.008 IPR • 0.80	= 0.0064 IPR

⚠ WARNING Tool failure can cause serious injury. To prevent:

- When using holders without support bushing, use a short GEN3SYS holder to establish an initial hole that is a minimum of 2 diameters deep.
- Do not rotate tool holders more than 50 RPM unless it is engaged with the workpiece or fixture.

Visit www.alliedmachine.com/DeepHoleGuidelines for the most up-to-date information and procedures. Factory technical assistance is available for your specific applications through our Application Engineering Team. ext: 7611 | email: appeng@alliedmachine.com

IMPORTANT: The speeds and feeds listed above are a general starting point for all applications. Refer to the coolant recommendation charts for coolant requirements to run at the recommended speeds and feeds. Factory technical assistance is available through our Application Engineering department. For 7xD, 10xD, and 12xD holder lengths, see adjustment example above.

A
DRILLING
B
BORING
C
REAMING
D
BURNISHING
E
THREADING
X
SPECIALS

Feed Rate (IPR) by Diameter									
15 series 0.5906" - 0.6298"	16 series 0.6299" - 0.6692"	17 series 0.6693" - 0.7086"	18 series 0.7087" - 0.7873"	20 series 0.7874" - 0.8660"	22 series 0.8661" - 0.9448"	24 series 0.9449" - 1.0235"	26 series 1.0236" - 1.1416"	29 series 1.1417" - 1.2597"	32 series 1.2598" - 1.3780"
0.006	0.007	0.008	0.009	0.009	0.009	0.010	0.010	0.011	0.011
0.006	0.006	0.007	0.008	0.009	0.009	0.009	0.009	0.010	0.010
0.006	0.006	0.006	0.007	0.008	0.008	0.009	0.009	0.009	0.009
0.006	0.007	0.007	0.008	0.009	0.009	0.009	0.009	0.010	0.010
0.006	0.006	0.007	0.007	0.008	0.008	0.009	0.009	0.009	0.009
0.014	0.015	0.017	0.018	0.018	0.020	0.020	0.022	0.023	0.024
0.013	0.014	0.016	0.017	0.018	0.018	0.020	0.020	0.022	0.022
0.012	0.013	0.015	0.016	0.017	0.018	0.018	0.020	0.020	0.021
0.011	0.012	0.014	0.015	0.016	0.017	0.018	0.018	0.020	0.020
0.010	0.011	0.013	0.014	0.015	0.016	0.017	0.018	0.018	0.019
0.015	0.016	0.018	0.019	0.020	0.021	0.022	0.023	0.024	0.025
0.014	0.015	0.017	0.018	0.019	0.020	0.021	0.022	0.023	0.024
0.013	0.014	0.016	0.018	0.018	0.019	0.020	0.021	0.022	0.023
0.012	0.013	0.015	0.017	0.017	0.018	0.019	0.020	0.021	0.022
0.012	0.013	0.014	0.016	0.016	0.017	0.018	0.019	0.020	0.021
0.015	0.016	0.017	0.017	0.018	0.019	0.020	0.021	0.022	0.023
0.014	0.015	0.016	0.016	0.017	0.018	0.019	0.020	0.021	0.021
0.017	0.017	0.018	0.020	0.021	0.022	0.024	0.025	0.027	0.028
0.016	0.016	0.017	0.019	0.020	0.021	0.023	0.024	0.026	0.027
0.012	0.013	0.014	0.014	0.015	0.016	0.017	0.017	0.017	0.017
0.011	0.011	0.012	0.013	0.014	0.015	0.016	0.016	0.016	0.016
0.014	0.015	0.016	0.017	0.018	0.020	0.021	0.022	0.024	0.024
0.005	0.006	0.006	0.006	0.007	0.007	0.007	0.009	0.009	0.010

Coolant Recommendations

Series	3xD, 5xD		7xD		10xD, 12xD	
	Pressure PSI	Flow Rate GPM	Pressure PSI	Flow Rate GPM	Pressure PSI	Flow Rate GPM
11	450	5	600	8	800	10
12	450	5	600	8	800	10
13	400	6	500	9.5	750	12
14	400	7	500	9.5	750	12
15	380	7	475	11	700	14
16	380	8	475	12	700	15
17	350	8	450	12.5	650	16.5
18	350	9	450	12.5	650	16.5
20	300	10	400	13	600	18
22	300	11	400	14	600	18
24	300	11	400	14	600	18
26	300	12	400	16	600	20
29	300	12	400	16	600	20
32	300	12	400	16	600	20

Recommended Drilling Data | Metric (mm)

GEN3SYS XT Pro

ISO	Material	Hardness (BHN)	Speed (M/mm)	Feed Rate (mm/rev) by Diameter			
				11 series 11.00 mm - 11.99 mm	12 series 12.00 mm - 12.99 mm	13 series 13.00 mm - 13.99 mm	14 series 14.00 mm - 14.99 mm
P	Free-Machining Steel 1118, 1215, 12L14, etc.	100 - 150	168	0.28	0.30	0.33	0.36
		150 - 200	145	0.25	0.28	0.30	0.33
		200 - 250	130	0.20	0.23	0.25	0.28
	Low-Carbon Steel 1010, 1020, 1025, 1522, 1144, etc.	85 - 125	158	0.28	0.3	0.33	0.36
		125 - 175	137	0.25	0.28	0.30	0.33
		175 - 225	125	0.23	0.25	0.28	0.30
	Medium-Carbon Steel 1030, 1040, 1050, 1527, 1140, 1151, etc.	225 - 275	107	0.18	0.20	0.23	0.25
		125 - 175	137	0.25	0.28	0.30	0.33
		175 - 225	125	0.23	0.25	0.28	0.30
	Alloy Steel 4140, 5140, 8640, etc.	225 - 275	107	0.20	0.23	0.25	0.28
		275 - 325	91	0.18	0.20	0.23	0.25
		125 - 175	126	0.25	0.28	0.30	0.33
		175 - 225	116	0.23	0.25	0.28	0.30
	High-Strength Alloy 4340, 4330V, 300M, etc.	225 - 275	104	0.20	0.23	0.25	0.28
		275 - 325	94	0.15	0.18	0.20	0.23
		325 - 375	85	0.15	0.15	0.18	0.20
	Structural Steel A36, A285, A516, etc.	300 - 350	69	0.15	0.18	0.20	0.23
		350 - 400	61	0.13	0.18	0.18	0.20
100 - 150		125	0.25	0.28	0.30	0.33	
Tool Steel H-13, H-21, A-4, O-2, S-3, etc.	150 - 250	101	0.20	0.23	0.25	0.28	
	250 - 350	93	0.18	0.20	0.23	0.25	
S	High-Temp Alloy Hastelloy B, Inconel 600, etc.	150 - 200	81	0.15	0.18	0.18	0.20
		200 - 250	62	0.13	0.15	0.15	0.18
	Titanium Alloy	140 - 220	40	0.15	0.18	0.18	0.20
		220 - 310	30	0.13	0.15	0.15	0.18
	Aerospace Alloy S82	140 - 220	43	0.13	0.15	0.18	0.20
220 - 310		34	0.10	0.13	0.15	0.18	
M	Stainless Steel 400 Series 416, 420, etc.	185 - 275	50	0.10	0.10	0.12	0.14
		275 - 350	41	0.09	0.09	0.10	0.12
	Stainless Steel 300 Series 304, 316, 17-4PH, etc.	185 - 275	73	0.15	0.18	0.18	0.20
		275 - 350	56	0.13	0.15	0.15	0.18
	Super Duplex Stainless Steel	135 - 185	64	0.10	0.13	0.13	0.15
135 - 185		47	0.08	0.10	0.10	0.13	
185 - 275	38	0.08	0.08	0.08	0.10		
185 - 275	30	0.05	0.05	0.08	0.08		

7xD Adjustment Example (0.80 Adjustment)

Data • Adjustment Value	Speed/Feed (7xD)
61 M/min • 0.80	= 48.8 M/min
0.20 mm/rev • 0.80	= 0.16 mm/rev

10xD and 12xD Adjustment Example (0.70 Adjustment)

Speed • Adjustment Value	Speed/Feed (10xD/12xD)
61 M/min • 0.70	= 42.7 M/min
0.20 mm/rev • 0.70	= 0.14 mm/rev

⚠ WARNING Tool failure can cause serious injury. To prevent:

- When using holders without support bushing, use a short GEN3SYS holder to establish an initial hole that is a minimum of 2 diameters deep.
- Do not rotate tool holders more than 50 RPM unless it is engaged with the workpiece or fixture.

Visit www.alliedmachine.com/DeepHoleGuidelines for the most up-to-date information and procedures. Factory technical assistance is available for your specific applications through our Application Engineering Team. ext: 7611 | email: appeng@alliedmachine.com

IMPORTANT: The speeds and feeds listed above are a general starting point for all applications. Refer to the coolant recommendation charts for coolant requirements to run at the recommended speeds and feeds. Factory technical assistance is available through our Application Engineering department. For 7xD, 10xD, and 12xD holder lengths, see adjustment example above.

A
DRILLING
B
BORING
C
REAMING
D
BURNISHING
E
THREADING
X
SPECIALS

Feed Rate (mm/rev) by Diameter									
15 series 15.00 mm - 15.99 mm	16 series 16.00 mm - 16.99 mm	17 series 17.00 mm - 17.99 mm	18 series 18.00 mm - 19.99 mm	20 series 20.00 mm - 21.99 mm	22 series 22.00 mm - 23.99 mm	24 series 24.00 mm - 25.99 mm	26 series 26.00 mm - 28.99 mm	29 series 29.00 mm - 31.99 mm	32 series 32.00 mm - 35.00 mm
0.38	0.41	0.43	0.48	0.53	0.56	0.58	0.61	0.64	0.66
0.36	0.38	0.41	0.43	0.48	0.51	0.53	0.56	0.58	0.61
0.30	0.33	0.36	0.41	0.46	0.48	0.51	0.53	0.56	0.58
0.38	0.41	0.43	0.48	0.53	0.56	0.58	0.61	0.64	0.66
0.36	0.38	0.41	0.46	0.48	0.51	0.53	0.56	0.58	0.61
0.33	0.36	0.38	0.42	0.46	0.48	0.51	0.53	0.56	0.58
0.28	0.30	0.33	0.38	0.41	0.42	0.46	0.48	0.51	0.53
0.36	0.38	0.41	0.46	0.51	0.53	0.56	0.58	0.61	0.64
0.33	0.36	0.38	0.43	0.48	0.51	0.53	0.56	0.58	0.61
0.30	0.33	0.36	0.41	0.46	0.48	0.51	0.53	0.56	0.58
0.28	0.30	0.33	0.38	0.41	0.43	0.46	0.48	0.51	0.53
0.36	0.38	0.41	0.46	0.51	0.53	0.56	0.58	0.61	0.64
0.33	0.36	0.38	0.43	0.48	0.51	0.53	0.56	0.58	0.61
0.30	0.33	0.36	0.41	0.46	0.48	0.51	0.53	0.56	0.58
0.25	0.28	0.30	0.36	0.38	0.41	0.43	0.46	0.48	0.51
0.23	0.25	0.28	0.33	0.36	0.38	0.41	0.43	0.46	0.48
0.28	0.30	0.33	0.36	0.38	0.41	0.43	0.46	0.48	0.51
0.25	0.28	0.28	0.30	0.33	0.36	0.38	0.41	0.43	0.46
0.23	0.25	0.25	0.28	0.30	0.33	0.36	0.38	0.41	0.43
0.33	0.38	0.38	0.43	0.48	0.53	0.56	0.58	0.61	0.64
0.30	0.33	0.36	0.38	0.43	0.48	0.51	0.53	0.56	0.58
0.28	0.30	0.33	0.36	0.38	0.43	0.48	0.51	0.53	0.56
0.20	0.23	0.23	0.25	0.28	0.30	0.33	0.36	0.38	0.41
0.18	0.20	0.20	0.23	0.25	0.28	0.30	0.33	0.36	0.38
0.20	0.23	0.23	0.25	0.28	0.28	0.30	0.30	0.33	0.36
0.18	0.20	0.20	0.23	0.25	0.25	0.28	0.28	0.30	0.33
0.20	0.23	0.23	0.25	0.28	0.28	0.30	0.30	0.33	0.33
0.18	0.20	0.20	0.23	0.25	0.25	0.28	0.28	0.30	0.30
0.15	0.16	0.18	0.18	0.20	0.22	0.24	0.26	0.28	0.31
0.14	0.15	0.16	0.16	0.18	0.20	0.22	0.24	0.26	0.29
0.20	0.23	0.25	0.28	0.30	0.33	0.36	0.38	0.41	0.43
0.18	0.20	0.23	0.25	0.28	0.30	0.33	0.36	0.38	0.41
0.15	0.18	0.18	0.20	0.20	0.23	0.23	0.25	0.25	0.28
0.13	0.15	0.15	0.18	0.18	0.20	0.20	0.23	0.23	0.25
0.10	0.13	0.13	0.15	0.15	0.18	0.20	0.20	0.20	0.25
0.10	0.10	0.13	0.13	0.15	0.15	0.18	0.18	0.20	0.20

Coolant Recommendations

Series	Stub, 3xD, 5xD		7xD		10xD, 12xD	
	Pressure BAR	Flow Rate LPM	Pressure BAR	Flow Rate LPM	Pressure BAR	Flow Rate LPM
11	31	19	41	30	55	38
12	31	19	41	30	55	38
13	28	23	34	36	52	45
14	28	26	34	36	52	45
15	26	26	33	42	48	53
16	26	30	33	45	48	57
17	24	30	31	47	45	62
18	24	34	31	47	45	62
20	21	38	28	49	41	68
22	21	42	28	53	41	68
24	21	42	28	53	41	68
26	21	45	28	61	41	76
29	21	45	28	61	41	76
32	21	45	28	61	41	76

Recommended Drilling Data | Metric (mm)

GEN3SYS XT Pro

ISO	Material	Hardness (BHN)	Speed (M/min)	Feed Rate (mm/rev) by Diameter			
				11 series 11.00 mm - 11.99 mm	12 series 12.00 mm - 12.99 mm	13 series 13.00 mm - 13.99 mm	14 series 14.00 mm - 14.99 mm
H	Wear Plate Hardox®, AR400, T-1, etc.	400	50	0.13	0.13	0.15	0.17
		500	40	0.11	0.11	0.13	0.15
		600	27	0.10	0.10	0.11	0.13
	Hardened Steel	300 - 400	51	0.13	0.13	0.15	0.17
400 - 500		40	0.11	0.11	0.13	0.15	
K	SG / Nodular Cast Iron	120 - 150	168	0.27	0.30	0.33	0.36
		150 - 200	159	0.25	0.28	0.30	0.33
		200 - 220	141	0.22	0.25	0.28	0.30
		220 - 260	124	0.20	0.23	0.25	0.28
		260 - 320	112	0.20	0.21	0.23	0.25
	Grey / White Iron	120 - 150	175	0.30	0.33	0.36	0.38
		150 - 200	168	0.28	0.30	0.33	0.36
		200 - 220	151	0.25	0.28	0.30	0.33
		220 - 260	130	0.23	0.25	0.28	0.30
		260 - 320	116	0.23	0.25	0.28	0.30
N	Cast Aluminum	30	351	0.30	0.33	0.36	0.38
		180	262	0.28	0.30	0.33	0.36
	Wrought Aluminum	30	488	0.33	0.38	0.41	0.43
		180	351	0.30	0.36	0.38	0.41
	Aluminum Bronze	100 - 200	126	0.26	0.28	0.30	0.32
		200 - 250	103	0.22	0.24	0.26	0.28
	Brass	100	230	0.29	0.30	0.33	0.36
Copper	60	149	0.07	0.08	0.09	0.11	

7xD Adjustment Example (0.80 Adjustment)

Data • Adjustment Value	Speed/Feed (7xD)
61 M/min • 0.80	= 48.8 M/min
0.20 mm/rev • 0.80	= 0.16 mm/rev

10xD and 12xD Adjustment Example (0.70 Adjustment)

Speed • Adjustment Value	Speed/Feed (10xD/12xD)
61 M/min • 0.70	= 42.7 M/min
0.20 mm/rev • 0.70	= 0.14 mm/rev

⚠ WARNING Tool failure can cause serious injury. To prevent:

- When using holders without support bushing, use a short GEN3SYS holder to establish an initial hole that is a minimum of 2 diameters deep.
- Do not rotate tool holders more than 50 RPM unless it is engaged with the workpiece or fixture.

Visit www.alliedmachine.com/DeepHoleGuidelines for the most up-to-date information and procedures. Factory technical assistance is available for your specific applications through our Application Engineering Team. ext: 7611 | email: appeng@alliedmachine.com

IMPORTANT: The speeds and feeds listed above are a general starting point for all applications. Refer to the coolant recommendation charts for coolant requirements to run at the recommended speeds and feeds. Factory technical assistance is available through our Application Engineering department. For 7xD, 10xD, and 12xD holder lengths, see adjustment example above.

A
DRILLING
B
BORING
C
REAMING
D
BURNISHING
E
THREADING
X
SPECIALS

Feed Rate (mm/rev) by Diameter									
15 series 15.00mm - 15.99mm	16 series 16.00 mm - 16.99 mm	17 series 17.00 mm - 17.99 mm	18 series 18.00 mm - 19.99 mm	20 series 20.00 mm - 21.99 mm	22 series 22.00 mm - 23.99 mm	24 series 24.00 mm - 25.99 mm	26 series 26.00 mm - 28.99 mm	29 series 29.00 mm - 31.99 mm	32 series 32.00 mm - 35.00 mm
0.19	0.21	0.23	0.25	0.27	0.27	0.29	0.29	0.31	0.31
0.17	0.19	0.21	0.23	0.25	0.25	0.27	0.27	0.29	0.29
0.15	0.17	0.19	0.21	0.23	0.23	0.25	0.25	0.25	0.27
0.19	0.21	0.22	0.23	0.25	0.25	0.27	0.27	0.29	0.29
0.17	0.19	0.20	0.21	0.23	0.23	0.25	0.25	0.27	0.27
0.38	0.41	0.46	0.51	0.53	0.56	0.58	0.61	0.64	0.66
0.36	0.38	0.43	0.48	0.51	0.53	0.56	0.58	0.61	0.63
0.33	0.36	0.41	0.46	0.48	0.51	0.53	0.56	0.58	0.60
0.30	0.33	0.38	0.43	0.46	0.48	0.51	0.53	0.56	0.58
0.28	0.30	0.36	0.38	0.43	0.46	0.48	0.51	0.53	0.55
0.41	0.43	0.48	0.53	0.56	0.58	0.61	0.64	0.66	0.69
0.38	0.41	0.46	0.51	0.53	0.56	0.58	0.61	0.64	0.66
0.36	0.38	0.43	0.51	0.51	0.53	0.56	0.58	0.61	0.64
0.33	0.36	0.41	0.46	0.48	0.51	0.53	0.56	0.58	0.61
0.33	0.36	0.38	0.43	0.46	0.48	0.51	0.53	0.56	0.58
0.41	0.43	0.46	0.48	0.51	0.53	0.56	0.58	0.61	0.64
0.38	0.41	0.43	0.46	0.48	0.51	0.53	0.56	0.58	0.58
0.46	0.48	0.51	0.53	0.56	0.61	0.66	0.69	0.74	0.76
0.43	0.46	0.48	0.53	0.56	0.58	0.64	0.66	0.71	0.74
0.34	0.36	0.38	0.40	0.42	0.44	0.46	0.48	0.48	0.50
0.30	0.32	0.34	0.36	0.38	0.42	0.46	0.46	0.46	0.48
0.38	0.41	0.43	0.48	0.53	0.56	0.60	0.63	0.66	0.66
0.13	0.15	0.16	0.18	0.20	0.20	0.22	0.25	0.25	0.28

Coolant Recommendations

Series	Stub, 3xD, 5xD		7xD		10xD, 12xD	
	Pressure BAR	Flow Rate LPM	Pressure BAR	Flow Rate LPM	Pressure BAR	Flow Rate LPM
11	31	19	41	30	55	38
12	31	19	41	30	55	38
13	28	23	34	36	52	45
14	28	26	34	36	52	45
15	26	26	33	42	48	53
16	26	30	33	45	48	57
17	24	30	31	47	45	62
18	24	34	31	47	45	62
20	21	38	28	49	41	68
22	21	42	28	53	41	68
24	21	42	28	53	41	68
26	21	45	28	61	41	76
29	21	45	28	61	41	76
32	21	45	28	61	41	76

Recommended Drilling Data | Metric (mm)

GEN3SYS XT

ISO	Material	Hardness (BHN)	Speed (M/mm)	Feed Rate (mm/rev) by Diameter			
				11 series 11.00 mm - 11.99 mm	12 series 12.00 mm - 12.99 mm	13 series 13.00 mm - 13.99 mm	14 series 14.00 mm - 14.99 mm
P	Free-Machining Steel 1118, 1215, 12L14, etc.	100 - 150	146	0.23	0.28	0.30	0.33
		150 - 200	126	0.23	0.26	0.28	0.30
		200 - 250	119	0.19	0.21	0.23	0.26
	Low-Carbon Steel 1010, 1020, 1025, 1522, 1144, etc.	85 - 125	137	0.26	0.28	0.30	0.33
		125 - 175	119	0.23	0.26	0.28	0.30
		175 - 225	108	0.21	0.23	0.26	0.28
	Medium-Carbon Steel 1030, 1040, 1050, 1527, 1140, 1151, etc.	225 - 275	95	0.16	0.19	0.21	0.23
		125 - 175	119	0.23	0.26	0.28	0.30
		175 - 225	108	0.21	0.23	0.26	0.28
	Alloy Steel 4140, 5140, 8640, etc.	225 - 275	95	0.19	0.21	0.23	0.26
		275 - 325	81	0.16	0.19	0.21	0.23
		275 - 325	87	0.14	0.16	0.19	0.21
325 - 375		78	0.14	0.14	0.16	0.19	
High-Strength Alloy 4340, 4330V, 300M, etc.	225 - 300	70	0.19	0.21	0.23	0.26	
	300 - 350	63	0.14	0.16	0.19	0.21	
	350 - 400	56	0.12	0.14	0.16	0.19	
Structural Steel A36, A285, A516, etc.	100 - 150	108	0.23	0.26	0.28	0.30	
	150 - 250	87	0.19	0.21	0.23	0.26	
	250 - 350	81	0.16	0.19	0.21	0.23	
Tool Steel H-13, H-21, A-4, O-2, S-3, etc.	150 - 200	78	0.14	0.16	0.16	0.19	
	200 - 250	59	0.12	0.14	0.14	0.16	
S	High-Temp Alloy Hastelloy B, Inconel 600, etc.	140 - 220	37	0.14	0.16	0.16	0.19
		220 - 310	29	0.12	0.14	0.14	0.16
	Titanium Alloy	140 - 220	42	0.12	0.14	0.16	0.19
		220 - 310	33	0.09	0.12	0.14	0.16
	Aerospace Alloy S82	185 - 275	45	0.09	0.09	0.12	0.12
275 - 350		37	0.07	0.07	0.09	0.12	
M	Stainless Steel 400 Series 416, 420, etc.	185 - 275	73	0.15	0.18	0.18	0.20
		275 - 350	56	0.13	0.15	0.15	0.18
	Stainless Steel 300 Series 304, 316, 17-4PH, etc.	135 - 185	64	0.10	0.13	0.13	0.15
		185 - 275	47	0.08	0.10	0.10	0.13
	Super Duplex Stainless Steel	135 - 185	38	0.08	0.08	0.08	0.10
185 - 275		30	0.05	0.05	0.08	0.08	

7xD Adjustment Example (0.80 Adjustment)

Data • Adjustment Value	Speed/Feed (7xD)
61 M/min • 0.80	= 48.8 M/min
0.20 mm/rev • 0.80	= 0.16 mm/rev

⚠ WARNING Tool failure can cause serious injury. To prevent:

- When using holders without support bushing, use a short GEN3SYS holder to establish an initial hole that is a minimum of 2 diameters deep.
- Do not rotate tool holders more than 50 RPM unless it is engaged with the workpiece or fixture.

Visit www.alliedmachine.com/DeepHoleGuidelines for the most up-to-date information and procedures. Factory technical assistance is available for your specific applications through our Application Engineering Team. ext: 7611 | email: appeng@alliedmachine.com

IMPORTANT: The speeds and feeds listed above are a general starting point for all applications. Refer to the coolant recommendation charts for coolant requirements to run at the recommended speeds and feeds. Factory technical assistance is available through our Application Engineering department. For 7xD, 10xD, and 12xD holder lengths, see adjustment example above.

A
DRILLING
B
BORING
C
REAMING
D
BURNISHING
E
THREADING
X
SPECIALS

Feed Rate (mm/rev) by Diameter									
15 series 15.00 mm - 15.99 mm	16 series 16.00 mm - 16.99 mm	17 series 17.00 mm - 17.99 mm	18 series 18.00 mm - 19.99 mm	20 series 20.00 mm - 21.99 mm	22 series 22.00 mm - 23.99 mm	24 series 24.00 mm - 25.99 mm	26 series 26.00 mm - 28.99 mm	29 series 29.00 mm - 31.99 mm	32 series 32.00 mm - 35.00 mm
0.35	0.37	0.40	0.44	0.49	0.51	0.54	0.56	0.58	0.61
0.33	0.35	0.37	0.40	0.44	0.47	0.49	0.51	0.54	0.56
0.28	0.30	0.33	0.37	0.42	0.44	0.47	0.49	0.51	0.54
0.35	0.37	0.40	0.44	0.49	0.51	0.54	0.56	0.58	0.61
0.33	0.35	0.37	0.41	0.44	0.47	0.49	0.51	0.54	0.56
0.30	0.33	0.35	0.38	0.41	0.44	0.47	0.49	0.51	0.54
0.26	0.28	0.30	0.35	0.37	0.40	0.42	0.44	0.47	0.49
0.33	0.35	0.37	0.42	0.47	0.49	0.51	0.54	0.56	0.58
0.30	0.33	0.35	0.40	0.44	0.47	0.49	0.51	0.54	0.56
0.28	0.30	0.33	0.37	0.41	0.44	0.47	0.49	0.51	0.54
0.26	0.28	0.30	0.35	0.37	0.40	0.42	0.44	0.47	0.49
0.33	0.35	0.37	0.42	0.47	0.49	0.51	0.54	0.56	0.58
0.30	0.33	0.35	0.40	0.44	0.47	0.49	0.51	0.54	0.56
0.28	0.30	0.33	0.37	0.38	0.44	0.47	0.49	0.51	0.54
0.23	0.26	0.28	0.33	0.35	0.37	0.40	0.42	0.46	0.47
0.21	0.23	0.26	0.30	0.33	0.35	0.37	0.40	0.42	0.44
0.26	0.28	0.30	0.33	0.35	0.37	0.40	0.42	0.44	0.47
0.23	0.26	0.26	0.28	0.30	0.33	0.35	0.37	0.40	0.42
0.21	0.23	0.23	0.26	0.28	0.30	0.33	0.35	0.37	0.40
0.30	0.35	0.35	0.40	0.44	0.49	0.51	0.54	0.56	0.58
0.28	0.30	0.33	0.35	0.40	0.44	0.47	0.49	0.51	0.54
0.26	0.28	0.30	0.33	0.35	0.40	0.44	0.47	0.49	0.51
0.19	0.21	0.21	0.23	0.26	0.28	0.30	0.33	0.35	0.37
0.16	0.19	0.19	0.21	0.23	0.26	0.28	0.30	0.33	0.35
0.19	0.21	0.21	0.23	0.26	0.26	0.28	0.28	0.30	0.33
0.16	0.19	0.19	0.21	0.23	0.23	0.26	0.26	0.28	0.30
0.19	0.21	0.21	0.23	0.26	0.26	0.28	0.28	0.30	0.33
0.16	0.19	0.19	0.21	0.23	0.23	0.26	0.26	0.28	0.28
0.14	0.14	0.16	0.16	0.19	0.19	0.21	0.23	0.26	0.28
0.12	0.14	0.14	0.14	0.16	0.19	0.19	0.21	0.23	0.26
0.20	0.23	0.25	0.28	0.30	0.33	0.36	0.38	0.41	0.43
0.18	0.20	0.23	0.25	0.28	0.30	0.33	0.36	0.38	0.41
0.15	0.18	0.18	0.20	0.20	0.23	0.23	0.25	0.25	0.28
0.13	0.15	0.15	0.18	0.18	0.20	0.20	0.23	0.23	0.25
0.10	0.13	0.13	0.15	0.15	0.18	0.20	0.20	0.20	0.25
0.10	0.10	0.13	0.13	0.15	0.15	0.18	0.18	0.20	0.20

Coolant Recommendations

Series	3xD, 5xD		7xD		10xD, 12xD	
	Pressure BAR	Flow Rate LPM	Pressure BAR	Flow Rate LPM	Pressure BAR	Flow Rate LPM
11	31	19	41	30	55	38
12	31	19	41	30	55	38
13	28	23	34	36	52	45
14	28	26	34	36	52	45
15	26	26	33	42	48	53
16	26	30	33	45	48	57
17	24	30	31	47	45	62
18	24	34	31	47	45	62
20	21	38	28	49	41	68
22	21	42	28	53	41	68
24	21	42	28	53	41	68
26	21	45	28	61	41	76
29	21	45	28	61	41	76
32	21	45	28	61	41	76

Recommended Drilling Data | Metric (mm)

GEN3SYS XT

ISO	Material	Hardness (BHN)	Speed (M/min)	Feed Rate (mm/rev) by Diameter			
				11 series 11.00 mm - 11.99 mm	12 series 12.00 mm - 12.99 mm	13 series 13.00 mm - 13.99 mm	14 series 14.00 mm - 14.99 mm
H	Wear Plate Hardox®, AR400, T-1, etc.	400	45	0.12	0.12	0.14	0.14
		500	37	0.09	0.09	0.12	0.14
		600	25	0.09	0.09	0.09	0.12
	Hardened Steel	300 - 400	47	0.12	0.12	0.14	0.14
400 - 500		37	0.09	0.09	0.12	0.14	
K	SG / Nodular Cast Iron	120 - 150	146	0.23	0.28	0.30	0.33
		150 - 200	138	0.23	0.26	0.28	0.30
		200 - 220	123	0.19	0.23	0.26	0.28
		220 - 260	108	0.19	0.21	0.23	0.26
		260 - 320	97	0.19	0.19	0.21	0.23
	Grey / White Iron	120 - 150	152	0.28	0.30	0.33	0.35
		150 - 200	146	0.26	0.28	0.30	0.33
		200 - 220	131	0.23	0.26	0.28	0.30
220 - 260		113	0.21	0.23	0.26	0.28	
N	Cast Aluminum	30	300	0.28	0.30	0.33	0.35
		180	225	0.26	0.28	0.30	0.33
	Wrought Aluminum	30	425	0.30	0.35	0.37	0.40
		180	300	0.28	0.33	0.35	0.37
	Aluminum Bronze	100 - 200	110	0.23	0.26	0.28	0.28
		200 - 250	90	0.19	0.21	0.23	0.26
	Brass	100	200	0.23	0.28	0.30	0.33
Copper	60	130	0.07	0.07	0.07	0.09	

7xD Adjustment Example (0.80 Adjustment)

Data • Adjustment Value	Speed/Feed (7xD)
61 M/min • 0.80	= 48.8 M/min
0.20 mm/rev • 0.80	= 0.16 mm/rev

⚠ WARNING Tool failure can cause serious injury. To prevent:

- When using holders without support bushing, use a short GEN3SYS holder to establish an initial hole that is a minimum of 2 diameters deep.
- Do not rotate tool holders more than 50 RPM unless it is engaged with the workpiece or fixture.

Visit www.alliedmachine.com/DeepHoleGuidelines for the most up-to-date information and procedures. Factory technical assistance is available for your specific applications through our Application Engineering Team. ext: 7611 | email: appeng@alliedmachine.com

IMPORTANT: The speeds and feeds listed above are a general starting point for all applications. Refer to the coolant recommendation charts for coolant requirements to run at the recommended speeds and feeds. Factory technical assistance is available through our Application Engineering department. For 7xD, 10xD, and 12xD holder lengths, see adjustment example above.

A
DRILLING
B
BORING
C
REAMING
D
BURNISHING
E
THREADING
X
SPECIALS

Feed Rate (mm/rev) by Diameter									
15 series 15.00 mm - 15.99 mm	16 series 16.00 mm - 16.99 mm	17 series 17.00 mm - 17.99 mm	18 series 18.00 mm - 19.99 mm	20 series 20.00 mm - 21.99 mm	22 series 22.00 mm - 23.99 mm	24 series 24.00 mm - 25.99 mm	26 series 26.00 mm - 28.99 mm	29 series 29.00 mm - 31.99 mm	32 series 32.00 mm - 35.00 mm
0.16	0.19	0.21	0.23	0.23	0.23	0.26	0.26	0.28	0.28
0.14	0.16	0.19	0.21	0.23	0.23	0.23	0.23	0.26	0.26
0.14	0.14	0.16	0.19	0.21	0.21	0.23	0.23	0.23	0.23
0.16	0.19	0.19	0.21	0.23	0.23	0.23	0.23	0.26	0.26
0.14	0.16	0.19	0.19	0.21	0.21	0.23	0.23	0.23	0.23
0.35	0.37	0.42	0.47	0.47	0.51	0.51	0.56	0.58	0.61
0.33	0.35	0.40	0.44	0.47	0.47	0.51	0.51	0.56	0.56
0.30	0.33	0.37	0.41	0.44	0.47	0.47	0.51	0.51	0.54
0.28	0.30	0.35	0.38	0.41	0.44	0.47	0.47	0.51	0.51
0.26	0.28	0.33	0.35	0.38	0.41	0.44	0.47	0.47	0.49
0.37	0.40	0.46	0.49	0.51	0.54	0.56	0.58	0.61	0.63
0.35	0.37	0.42	0.47	0.49	0.51	0.54	0.56	0.58	0.61
0.33	0.35	0.40	0.47	0.47	0.49	0.51	0.54	0.56	0.58
0.30	0.33	0.37	0.42	0.44	0.47	0.49	0.51	0.54	0.56
0.30	0.33	0.35	0.40	0.41	0.44	0.47	0.49	0.51	0.54
0.37	0.40	0.42	0.44	0.47	0.49	0.51	0.54	0.56	0.58
0.35	0.37	0.40	0.41	0.44	0.47	0.49	0.51	0.54	0.54
0.42	0.44	0.47	0.51	0.54	0.56	0.61	0.63	0.68	0.70
0.40	0.41	0.44	0.49	0.51	0.54	0.58	0.61	0.65	0.68
0.30	0.33	0.35	0.35	0.37	0.40	0.42	0.44	0.44	0.44
0.28	0.28	0.30	0.33	0.35	0.37	0.40	0.41	0.41	0.41
0.35	0.37	0.40	0.44	0.47	0.51	0.54	0.56	0.61	0.61
0.12	0.14	0.14	0.16	0.19	0.19	0.19	0.23	0.23	0.26

Coolant Recommendations

Series	3xD, 5xD		7xD		10xD, 12xD	
	Pressure BAR	Flow Rate LPM	Pressure BAR	Flow Rate LPM	Pressure BAR	Flow Rate LPM
11	31	19	41	30	55	38
12	31	19	41	30	55	38
13	28	23	34	36	52	45
14	28	26	34	36	52	45
15	26	26	33	42	48	53
16	26	30	33	45	48	57
17	24	30	31	47	45	62
18	24	34	31	47	45	62
20	21	38	28	49	41	68
22	21	42	28	53	41	68
24	21	42	28	53	41	68
26	21	45	28	61	41	76
29	21	45	28	61	41	76
32	21	45	28	61	41	76

Tap Drill Information and Formulas | Imperial (inch)

American - Unified Inch Screw Thread

Tap Size	Tap Drill Size	Decimal Equivalent	* Theo % Thread	Probable Mean Oversize	Probable Hole Size	** Probable % Thread
1/2 - 20	29/64	0.4531	72%	0.003	0.4561	68%
9/16 - 12	12.0 mm	0.4724	72%	0.003	0.4754	69%
	31/64	0.4844	83%	0.003	0.4874	80%
9/16 - 18	1/2	0.5000	87%	0.003	0.5030	82%
	13.0 mm	0.5118	70%	0.003	0.5148	66%
5/8 - 11	31/64	0.5156	65%	0.003	0.5186	61%
	17/32	0.5313	79%	0.003	0.5343	77%
5/8 - 12	35/64	0.5469	72%	0.003	0.5499	69%
5/8 - 18	9/16	0.5625	87%	0.003	0.5655	82%
	14.5 mm	0.5709	75%	0.003	0.5739	71%
11/16 - 12	37/64	0.5781	65%	0.003	0.5811	61%
	39/64	0.6094	72%	0.003	0.6124	69%
3/4 - 10	41/64	0.6406	84%	0.003	0.6436	82%
	16.5 mm	0.6496	77%	0.003	0.6526	75%
3/4 - 12	21/32	0.6563	72%	0.003	0.6593	70%
	43/64	0.6719	72%	0.003	0.6749	69%
3/4 - 16	11/16	0.6875	77%	0.003	0.6905	73%
	17.5 mm	0.6890	75%	0.003	0.6920	71%
7/8 - 9	49/64	0.7656	76%	0.003	0.7686	74%
	25/32	0.7813	65%	0.003	0.7843	63%
7/8 - 14	51/64	0.7969	84%	0.003	0.7999	81%
	13/16	0.8125	67%	0.003	0.8155	64%
15/16 - 12	55/64	0.8594	72%	0.003	0.8624	69%
15/16 - 20	57/64	0.8906	72%	0.003	0.8936	68%
1 - 8	22.0 mm	0.8661	82%	0.003	0.8691	81%
	7/8	0.8750	77%	0.003	0.8780	75%
1 - 12	57/64	0.8906	67%	0.003	0.8936	65%
	29/32	0.9063	87%	0.003	0.9093	84%
1 - 14	59/64	0.9219	72%	0.003	0.9249	69%
	15/16	0.9375	67%	0.003	0.9405	64%
1-1/8 - 12	1-1/32	1.0313	87%	0.003	1.0343	84%
	1-3/64	1.0469	72%	0.003	1.0499	69%
1-1/4 - 7	1-7/64	1.1094	76%	0.003	1.1124	74%

Taper Pipe Thread (NPT)

Tap Size	Tap Drill Size	Decimal Equivalent	* Theo % Thread	Probable Mean Oversize	Probable Hole Size	** Probable % Thread
1/4 - 18	7/16	0.4375	-	0.003	0.4405	-
3/8 - 18	9/16	0.5625	-	0.003	0.5655	-
1/2 - 14	45/64	0.7031	-	0.003	0.7061	-
3/4 - 14	29/32	0.9063	-	0.003	0.9093	-

* Based on nominal tap drill diameter

** Based on 0.003" probable mean oversize

To calculate the percent of full thread for a given hole diameter:

$$\% \text{ Thread} = \# \text{ of threads per inch} \cdot \frac{(\text{Basic major diameter of thread} - \text{Drill hole size})}{.0130}$$

Notes

- The above tap drill information represents probable thread percentages for the standard tap drills stocked at Allied Machine. Special insert diameters may be required in order to meet a user-specific percentage of thread requirement.
- The 0.003 probable mean oversize hole condition is based on optimum cutting conditions. Probable percent of full thread may vary based on less ideal cutting conditions.
- The table and equations on this page are found in the *Machinery's Handbook*. Permission to simplify and print the equations is granted by the editor of the *Machinery's Handbook*.

Formulas

1.	RPM = $(3.82 \cdot \text{SFM}) / \text{DIA}$ where: RPM = revolutions per minute (rev/min) SFM = speed (ft/min) DIA = diameter of drill (inch)
2.	IPM = $\text{RPM} \cdot \text{IPR}$ where: IPM = inches per minute (in/min) RPM = revolutions per minute (rev/min) IPR = feed rate (in/rev)
3.	SFM = $\text{RPM} \cdot 0.262 \cdot \text{DIA}$ where: SFM = speed (ft/min) RPM = revolutions per minute (rev/min) DIA = diameter of drill (inch)
4.	Thrust = $153,700 \cdot \text{IPR} \cdot \text{DIA} \cdot \text{Km}$ where: Thrust = axial thrust (lbs) IPR = feed rate (in/rev) DIA = diameter of drill (inch) Km = specific cutting energy (lbs/in ²)
5.	Tool Power = $.6991 \cdot \text{IPR} \cdot \text{RPM} \cdot \text{Km} \cdot \text{DIA}^2$ where: Tool Power = tool power (HP) IPR = feed rate (in/rev) RPM = revolutions per minute (rev/min) Km = specific cutting energy (lbs/in ²) DIA = diameter of drill (inch)

Material Constants

Type of Material	Hardness	K _m (lbs/in ²)
Plain Carbon and Alloy Steel	85 - 200 BHN	0.79
	200 - 275 BHN	0.94
	275 - 375 BHN	1.00
High-Temperature Alloys	-	1.44
Titanium Alloy	-	0.72
Stainless Steels	135 - 275 BHN	0.94
	30 - 45 RC	1.08
Cast Iron	100 - 200 BHN	0.50
	200 - 300 BHN	1.08
Copper Alloy	20 - 80 RB	0.43
	80 - 100 RB	0.72
Aluminum Alloy	-	0.22
Magnesium Alloy	-	0.16

Tap Drill Information and Formulas | Metric (mm)

Tap Size	Tap Drill Size	Decimal Equivalent (inch)	* Theo % Thread	Probable Mean Oversize	Probable Hole Size	** Probable % Thread
12 X 1.25	27/64	0.4219	79%	0.075 mm	10.79 mm	74%
	10.8 mm	0.4252	74%	0.075 mm	10.88 mm	69%
14 X 2.0	15/32	0.4688	81%	0.075 mm	11.98 mm	78%
	12.0 mm	0.4724	77%	0.075 mm	12.08 mm	74%
14 X 1.5	12.5 mm	0.4921	77%	0.075 mm	12.58 mm	73%
16 X 2.0	14.0 mm	0.5512	77%	0.075 mm	14.08 mm	74%
16 X 1.5	14.5 mm	0.5709	77%	0.075 mm	14.58 mm	73%
	37/64	0.5781	68%	0.075 mm	14.76 mm	64%
18 X 2.5	15.5 mm	0.6102	77%	0.075 mm	15.58 mm	75%
18 X 1.5	16.5 mm	0.6496	77%	0.075 mm	16.58 mm	73%
	21/32	0.6563	68%	0.075 mm	16.75 mm	64%
20 X 2.5	11/16	0.6875	78%	0.075 mm	17.54 mm	76%
	17.5 mm	0.6890	77%	0.075 mm	17.58 mm	74%
20 X 1.5	18.5 mm	0.7283	77%	0.075 mm	18.58 mm	73%
	47/64	0.7344	69%	0.075 mm	18.66 mm	65%
22 X 2.5	49/64	0.7656	79%	0.075 mm	19.52 mm	76%
	19.5 mm	0.7677	77%	0.075 mm	19.58 mm	75%
22 X 1.5	20.5 mm	0.8071	77%	0.075 mm	20.58 mm	73%
	13/16	0.8125	70%	0.075 mm	20.71 mm	66%
24 X 3	13/16	0.8125	86%	0.075 mm	20.71 mm	84%
	21.0 mm	0.8268	76%	0.075 mm	21.08 mm	75%
24 X 2	22.0 mm	0.8661	77%	0.075 mm	22.08 mm	74%
	7/8	0.8750	68%	0.075 mm	22.30 mm	65%
27 X 3	24.0 mm	0.9449	77%	0.075 mm	24.08 mm	75%

Formulas

1.	RPM	= (318.47 • M/min) / DIA
	where:	
	RPM	= revolutions per minute (rev/min)
	M/min	= speed (M/min)
	DIA	= diameter of drill (mm)
2.	mm/min	= RPM • mm/rev
	where:	
	mm/min	= millimeter per minute (mm/min)
	RPM	= revolutions per minute (rev/min)
	mm/rev	= feed rate (mm/rev)
3.	M/min	= RPM • 0.003 • DIA
	where:	
	M/min	= speed (M/min)
	RPM	= revolutions per minute (rev/min)
	DIA	= diameter of drill (mm)
4.	Thrust	= 154 • (mm/rev) • DIA • K_m
	where:	
	Thrust	= axial thrust (N)
	mm/rev	= feed rate (mm/rev)
	DIA	= diameter of drill (mm)
	K _m	= specific cutting energy (kPa)
5.	Tool Power	= ((mm/rev) • RPM • K_m • DIA²) / 218604.8
	where:	
	Tool Power	= tool power (HP)
	mm/rev	= feed rate (mm/rev)
	RPM	= revolutions per minute (rev/min)
	K _m	= specific cutting energy (kPa)
	DIA	= diameter of drill (mm)

BSP and ISO 7-1

Tap Size	Tap Drill Size	Decimal Equivalent	* Theo % Thread	Probable Mean Oversize	Probable Hole Size	** Probable % Thread
1/4-19	7/16"	0.4375"	-	0.075 mm	11.19 mm	-
3/8-19	37/64"	0.5781"	-	0.075 mm	14.76 mm	-
1/2-14	23/32"	0.7188"	-	0.075 mm	18.33 mm	-
3/4-14	15/16"	0.9375"	-	0.075 mm	23.89 mm	-

* Based on nominal tap drill diameter

** Based on 0.075 mm probable mean oversize

To calculate the percent of full thread for a given hole diameter:

$$\% \text{ Thread} = \frac{76.93}{\text{Pitch (mm)}} \cdot (\text{Basic major diameter} - \text{Drill hole size})$$

Notes

- The above tap drill information represents probable thread percentages for the standard tap drills stocked at Allied Machine. Special insert diameters may be required in order to meet a user specific percentage of thread requirement.
- The 0.075mm probable mean oversize hole condition is based on optimum cutting conditions. Probable percent of full thread may vary based on less ideal cutting conditions.
- The table and equations on this page are found in the *Machinery's Handbook*. Permission to simplify and print the equations is granted by the editor of the *Machinery's Handbook*.

Material Constants

Type of Material	Hardness	K _m (kPa)
Plain Carbon and Alloy Steel	85 - 200 BHN	5.45
	200 - 275 BHN	6.48
	275 - 375 BHN	6.89
	375 - 425 BHN	7.93
High-Temperature Alloys	-	9.93
Titanium Alloy	-	4.96
Stainless Steels	135 - 275 BHN	6.48
	30 - 45 RC	7.45
Cast Iron	100 - 200 BHN	3.45
	200 - 300 BHN	7.45
Copper Alloy	20 - 80 RB	2.96
	80 - 100 RB	4.96
Aluminum Alloy	-	1.52
Magnesium Alloy	-	1.10

Deep Hole Drilling Guidelines

GEN3SYS XT Pro | 10xD and 12xD Holders

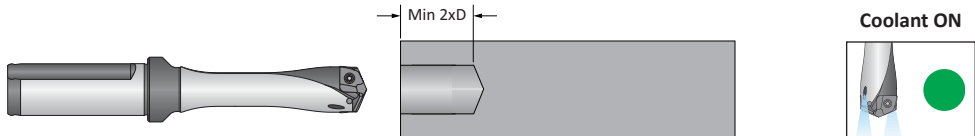
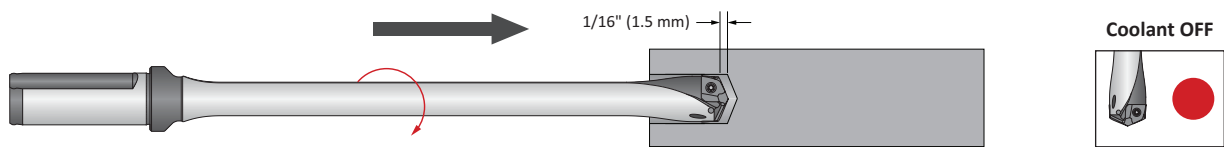
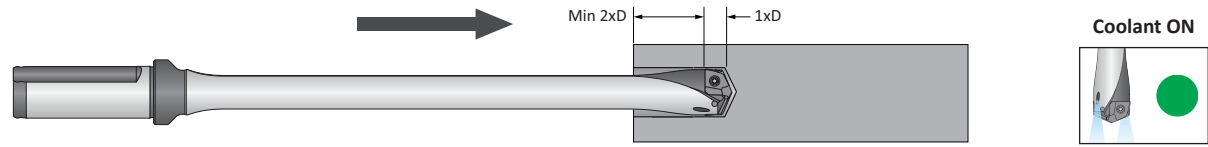
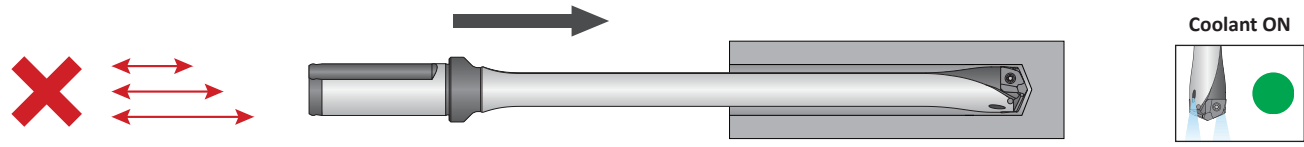
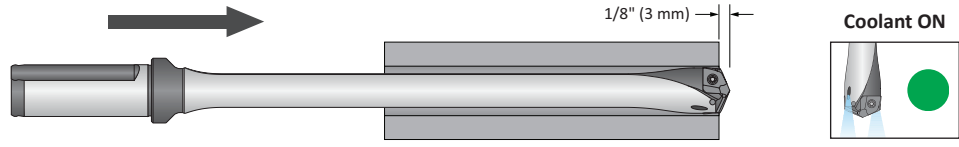
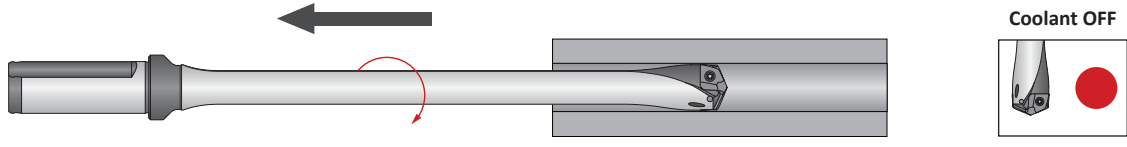
A DRILLING	<p>1. Pilot Hole 100 % RPM 100% IPR (mm/rev)</p>	<p>Establish the pilot hole using the same diameter short drill to a depth of 2xD minimum. Utilize a pilot drill with the same or larger included point angle.</p>	
B BORING	<p>2. Feed-in 50 RPM max 12 IPM (300 mm/min)</p>	<p>Feed the longer drill within 1/16" (1.5 mm) short of the established pilot hole bottom at a maximum of 50 RPM and 12 IPM (300 mm/min) feed rate.</p>	
C REAMING	<p>3. Deep Hole Transition Drilling 50 % RPM 75% IPR (mm/rev)</p>	<p>Drill additional 1xD past the bottom of the pilot hole at 50% reduction of recommended speed and 25% reduction of recommended feed. Minimum of 1 second dwell is required to meet full speed before feeding.</p>	
D BURNISHING	<p>4. Deep Hole Drilling - Blind 100% RPM 100% IPR (mm/rev)</p>	<p>Drill to full depth at recommended speed and feed for longer drill according to Allied speed and feed charts. No peck cycle recommended.</p>	
E THREADING	<p>5. Deep Hole Drilling - at Breakout 50% RPM 75% IPR (mm/rev)</p>	<p>For through holes only: Reduce speed by 50% and feed by 25% prior to breakout. Do not breakout more than 1/8" (3 mm) past the full diameter of the drill.</p>	
X SPECIALS	<p>6. Drill Retract 50 RPM max</p>	<p>Reduce speed to a maximum of 50 RPM before retracting from the hole.</p>	

1. WARNING Tool failure can cause serious injury. To prevent:

- When using holders without support bushing, use a short GEN3SYS holder to establish an initial hole that is a minimum of 2 diameters deep.
- Do not rotate tool holders more than 50 RPM unless it is engaged with the workpiece or fixture.

Visit www.alliedmachine.com/DeepHoleGuidelines for the most up-to-date information and procedures. Factory technical assistance is available for your specific applications through our Application Engineering Team. ext: 7611 | email: appeng@alliedmachine.com

Troubleshooting Guide

	Potential Problem																			
	Accelerated corner wear	Barber pole	Bell-mouth hole	Insert chipping	Blue chips	Built-up Edge (BUE)	Chatter	Chip packing	Chipping of point	Damaged or broken tools	Excessive margin wear	High flank wear	Hole lead off	Hole out of position	Hole out of round	Overize hole	Poor hole finish	Poor tool life	Power spikes - Load meter	
Setup Condition	1	2	3	4	5	6	7	8	9	10	11	12	13	14	15	16	17	18	19	Possible Solutions
Worn or misaligned spindle (lathe, screw machine, chucker)	1	2	3				7		9	10	11		13			16	17			<ul style="list-style-type: none"> Align spindle and turret or tailstock. Repair spindle.
Use of low rigidity machine tools		2	3	4			7		9	10			13	14						<ul style="list-style-type: none"> Reduce penetration rate to fall within the physical limits of the machine or setup (NOTICE: Do not reduce feed below threshold of good chip formation).
Poor work piece support		2		4			7			10	11				15		17			<ul style="list-style-type: none"> Provide additional support for the work piece. Reduce penetration rate to fall within the physical limits of the machine or setup (NOTICE: Do not reduce feed below threshold of good chip formation).
Flood coolant, low coolant pressure, or low coolant volume	1				5	6		8		10		12				16	17	18	19	<ul style="list-style-type: none"> Run coolant through tool holder when drilling greater than 1xD. Increase coolant pressure and volume through the tool holder. Reduce penetration rate to fall within the coolant limitations (NOTICE: Do not reduce feed below threshold of good chip formation). Add a peck cycle to help clear chips.
Interrupted cuts. Entry or exit surfaces that are not perpendicular to the spindle (draft angles, parting lines, curved or stepped surfaces, cross holes, and cast or forged surfaces)				4			7		9	10	11		13	14	15	16	17	18		<ul style="list-style-type: none"> Premill (spot face) entry or exit surface to remove interruption. Decrease feed as much as 50% through entry or exit interruption. Use short holders in low impact entry cuts.
Material harder than expected or running tools beyond recommended speed	1				5	6				10		12						18		<ul style="list-style-type: none"> Reduce speed. Increase coolant pressure and volume. Improve coolant condition by use of quality products and regular maintenance.
Poor material micro-structure or foreign particles (forgings and castings that have not been normalized or annealed, poorly prepared steel, flame cut parts, and sand casting)				4		6				10		12	13					18		<ul style="list-style-type: none"> Compare performance of other tools for similar wear problems, which may indicate poor micro-structure. Anneal or normalize parts to improve micro-structure for machining. Reduce feeds (NOTICE: Do not reduce feed below threshold of good chip formation).
Poor chip control								8		10	11		13			16	17	18	19	<ul style="list-style-type: none"> Increase feed to recommended levels. Contact Allied's Application Engineering group for technical recommendations. Increase coolant pressure and volume. Improve coolant condition by use of quality products and regular maintenance.
Spot drilled holes with included angle less than that matching GEN3SYS XT or cored holes	1			4			7						13					18		<ul style="list-style-type: none"> Spot hole with short tool of same or greater included angle as GEN3SYS XT drill insert. Reduce feed (NOTICE: Do not reduce feed below threshold of good chip formation). If possible, drill from solid.

A

DRILLING

B

BORING

C

REAMING

D

BURNISHING

E

THREADING

X

SPECIALS

Guaranteed Test / Demo Application Form

Distributor PO #	
------------------	--

The following must be filled out completely before your test will be considered

Distributor Information

Company Name: _____
 Contact: _____
 Account Number: _____
 Phone: _____
 Email: _____

End User Information

Company Name: _____
 Contact: _____
 Industry: _____
 Phone: _____
 Email: _____

Current Process List all tooling, coatings, substrates, speeds and feeds, tool life, and any problems you are experiencing

Test Objective List what would make this a successful test (i.e. penetration rate, finish, tool life, hole size, etc.)

Application Information

Hole Diameter: _____ in/mm	Tolerance: _____	Material: _____ (4150 / A36 / Cast Iron / etc.)
Preexisting Diameter: _____ in/mm	Depth of Cut: _____ in/mm	Hardness: _____ (BHN / Rc)
Required Finish: _____ RMS	State: _____ (Casting / Hot rolled / Forging)	

Machine Information

Machine Type: _____ (Lathe / Screw machine / Machine center / etc.)	Builder: _____ (Haas, Mori Seiki, etc.)	Model #: _____
Shank Required: _____ (CAT50 / Morse taper, etc.)		Power: _____ HP/KW
Rigidity: _____	Orientation: _____	Tool Rotating: _____
<input type="checkbox"/> Excellent	<input type="checkbox"/> Vertical	<input type="checkbox"/> Yes
<input type="checkbox"/> Good	<input type="checkbox"/> Horizontal	<input type="checkbox"/> No
<input type="checkbox"/> Poor		Thrust: _____ lbs/N

Coolant Information

Coolant Delivery: _____ (Through tool / Flood)	Coolant Pressure: _____ PSI / bar
Coolant Type: _____ (Air mist, oil, synthetic, water soluble, etc.)	Coolant Volume: _____ GPM / LPM

Requested Tooling

QTY	Item Number	QTY	Item Number



ALLIED MACHINE & ENGINEERING

Allied Machine & Engineering
 120 Deeds Drive
 Dover, OH 44622

Telephone: (330) 343-4283
 Toll Free USA & Canada: (800) 321-5537
 Fax: (330) 602-3400

Warranty Information



Allied Machine & Engineering ("Allied Machine") warrants to original equipment manufacturers, distributors, industrial and commercial users of its products for one year from the original date of sale that each new product manufactured or supplied by Allied Machine shall be free from defects in material and workmanship.

Allied Machine's sole and exclusive obligation under this warranty is limited to, at its option, without additional charge, replacing or repairing this product or issuing a credit. For this warranty to be applied, the product must be returned freight prepaid to the plant designated by an Allied Machine representative and which, upon inspection, is determined by Allied Machine to be defective in material and workmanship.

Complete information as to operating conditions, machine, setup, and the application of cutting fluid should accompany any product returned for inspection. This warranty shall not apply to any Allied Machine products which have been subjected to misuse, abuse, improper operating conditions, improper machine setup or improper application of cutting fluid or which have been repaired or altered if such repair or alteration, in the judgement of Allied Machine, would adversely affect the performance of the product.

THIS WARRANTY IS IN LIEU OF ALL OTHER WARRANTIES, EXPRESS OR IMPLIED, INCLUDING ANY IMPLIED WARRANTY OF MERCHANTABILITY OR FITNESS FOR A PARTICULAR PURPOSE. Allied Machine shall have no liability or responsibility for any claim, whether in contract, tort or otherwise, for any loss or damage arising out of, connected with, or resulting from the manufacture, sale, delivery or use of any product sold hereunder, in excess of the cost of replacement or repair as provided herein.

Allied Machine shall not be liable in contract or in tort (including, without limitation, negligence, strict liability or otherwise) for economic losses of any kind or for any special, incidental, indirect, consequential, punitive or exemplary damages arising in any way out of the performance of, or failure to perform this agreement.

ALL PRICES, DELIVERIES, DESIGNS, AND MATERIALS ARE SUBJECT TO CHANGE WITHOUT NOTICE.



Allied Machine & Engineering
is registered to
ISO 9001:2015 by DQS

United States

Allied Machine & Engineering
120 Deeds Drive
Dover OH 44622
United States

Phone:
+1.330.343.4283
Fax:
+1.330.602.3400

Toll Free USA and Canada:
800.321.5537
Toll Free USA and Canada:
800.223.5140

Allied Machine & Engineering
485 W Third Street
Dover OH 44622
United States

Phone:
+1.330.343.4283
Fax:
+1.330.364.7666
(Engineering Dept.)

Toll Free USA and Canada:
800.321.5537

Europe

Allied Machine & Engineering Co. (Europe) Ltd.
93 Vantage Point
Pensnett Estate
Kingswinford
West Midlands
DY6 7FR England

Phone:
+44 (0) 1384.400900

Wohlhaupter GmbH
Maybachstrasse 4
Postfach 1264
72636 Frickenhausen
Germany

Phone:
+49 (0) 7022.408.0
Fax:
+49 (0) 7022.408.212

Asia

Wohlhaupter India Pvt. Ltd.
B-23, 3rd Floor
B Block Community Centre
Janakpuri, New Delhi - 110058
India

Phone:
+91 (0) 11.41827044

Your local Allied Machine representative:

www.alliedmachine.com

Allied Machine & Engineering is registered to ISO 9001:2015 by DQS



Copyright © 2022 Allied Machine & Engineering Corp. All rights reserved.
All trademarks designated with the ® symbol are registered in the United States and other countries.
Available Online Only
Publish Date: 2022